

AXIDLW48S

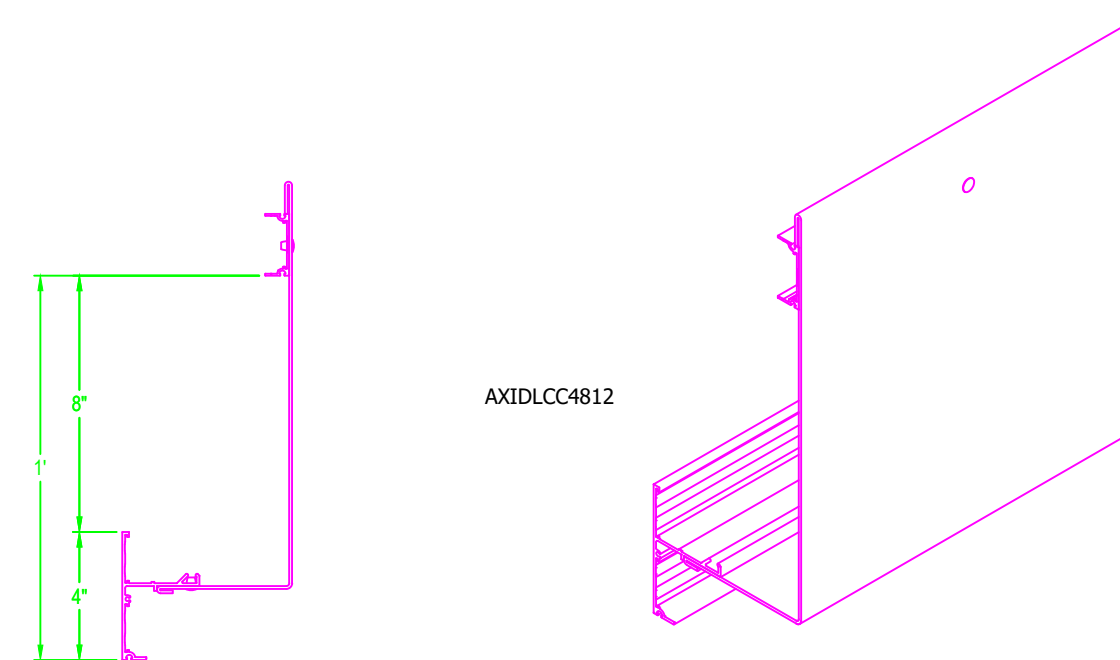

AXIDLCC4812

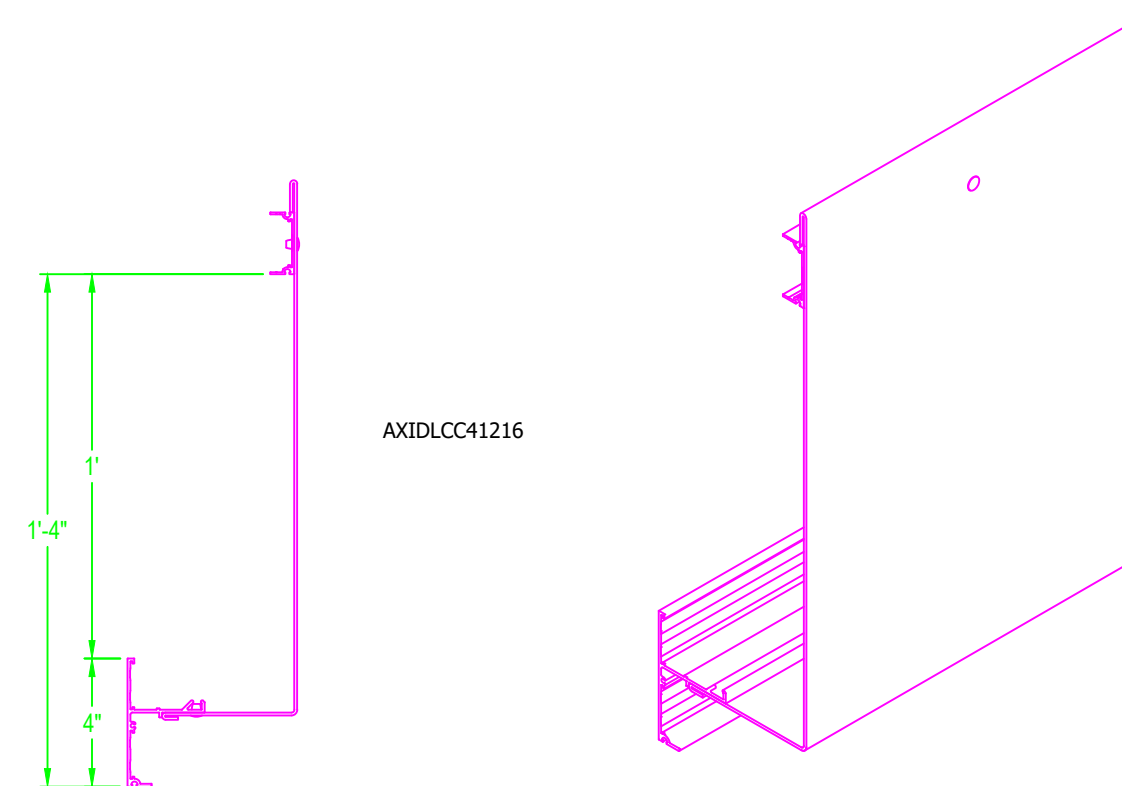

AXIDLCC41216

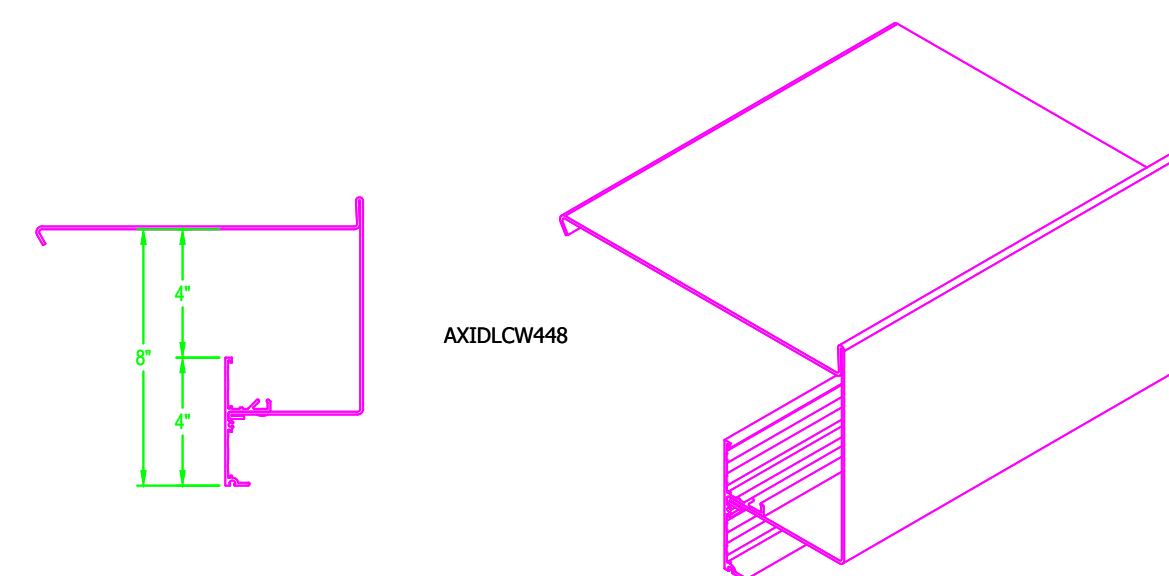

AXIDLW48

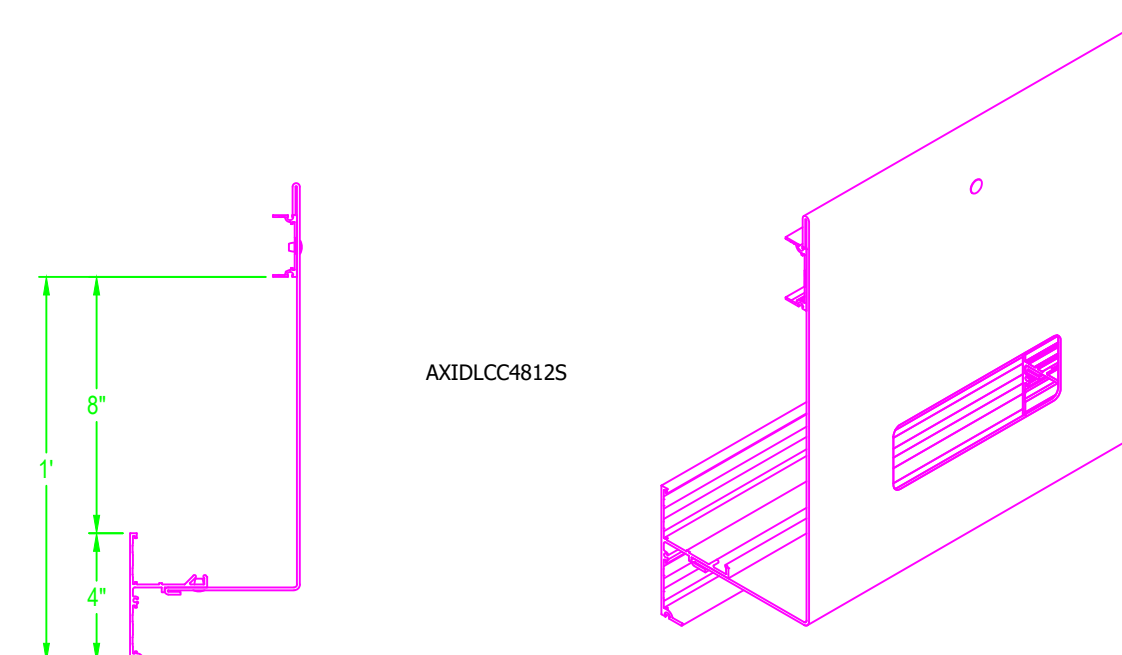

AXIDLCC4812S

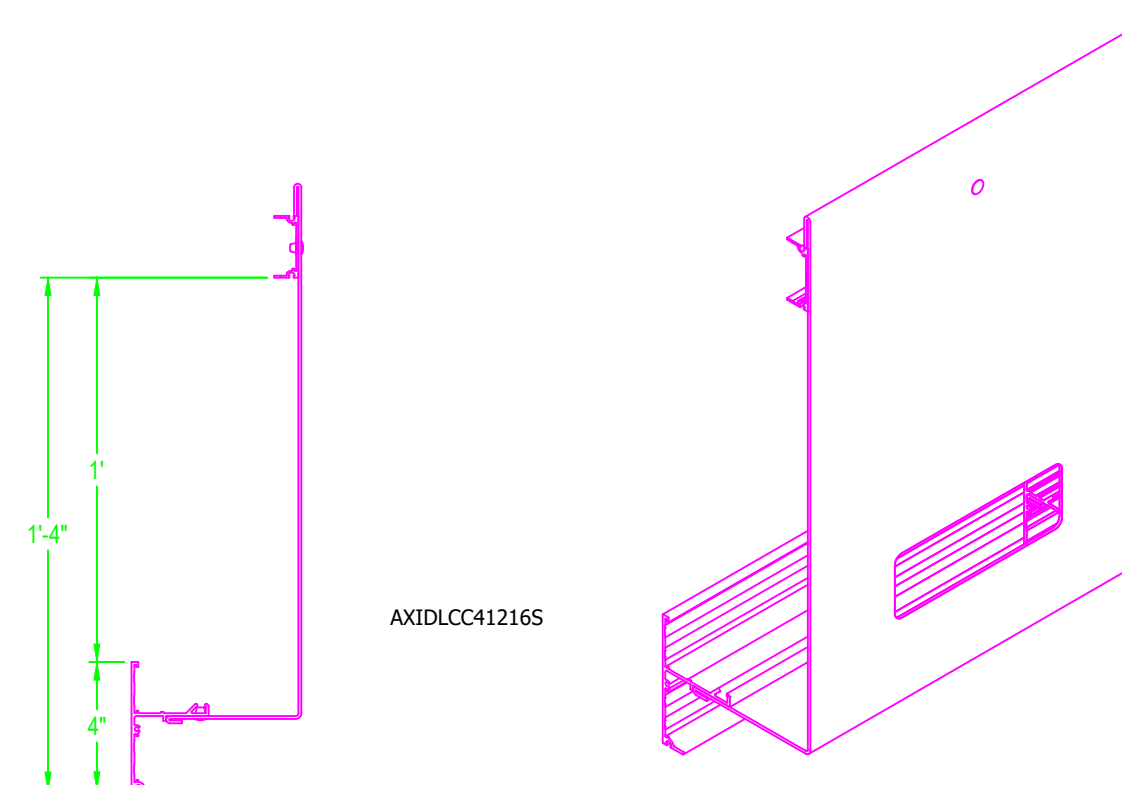

AXIDLCC41216S

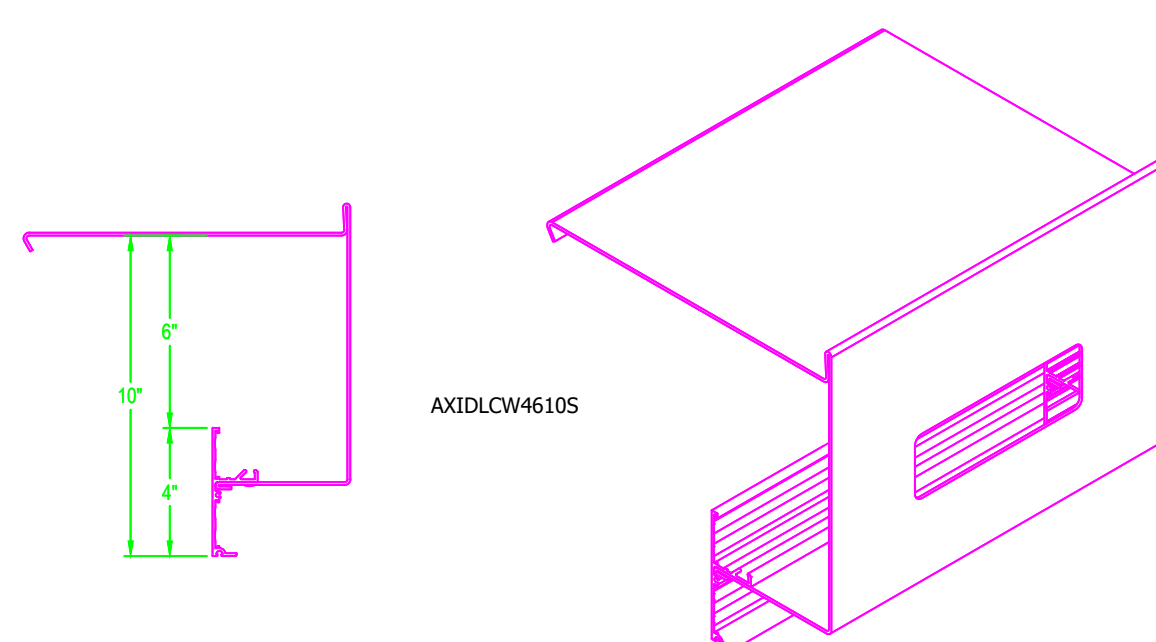

AXIDLW4610S

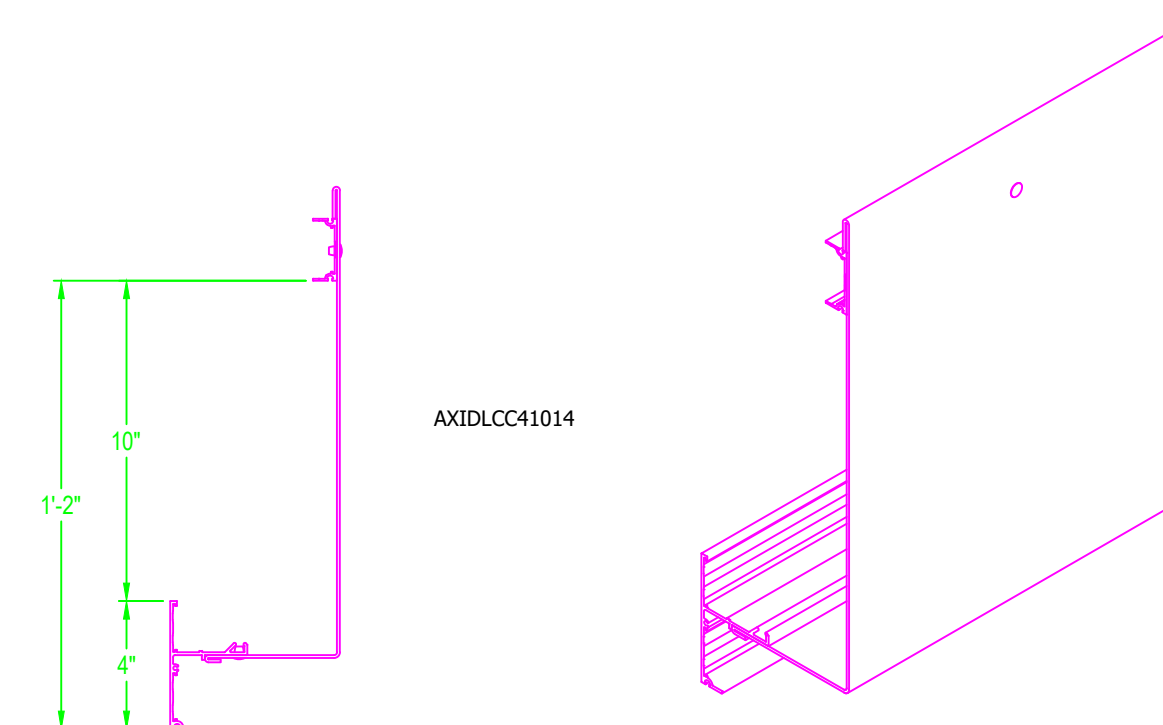

AXIDLCC41014

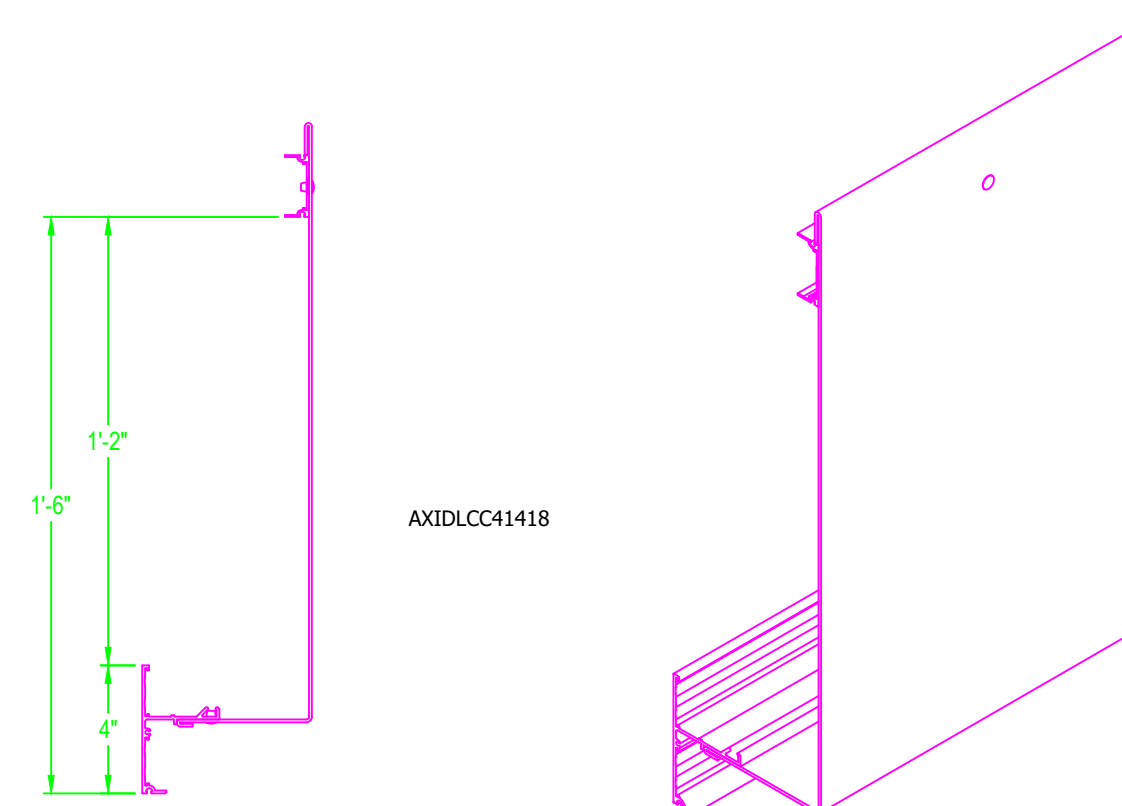

AXIDLCC41418

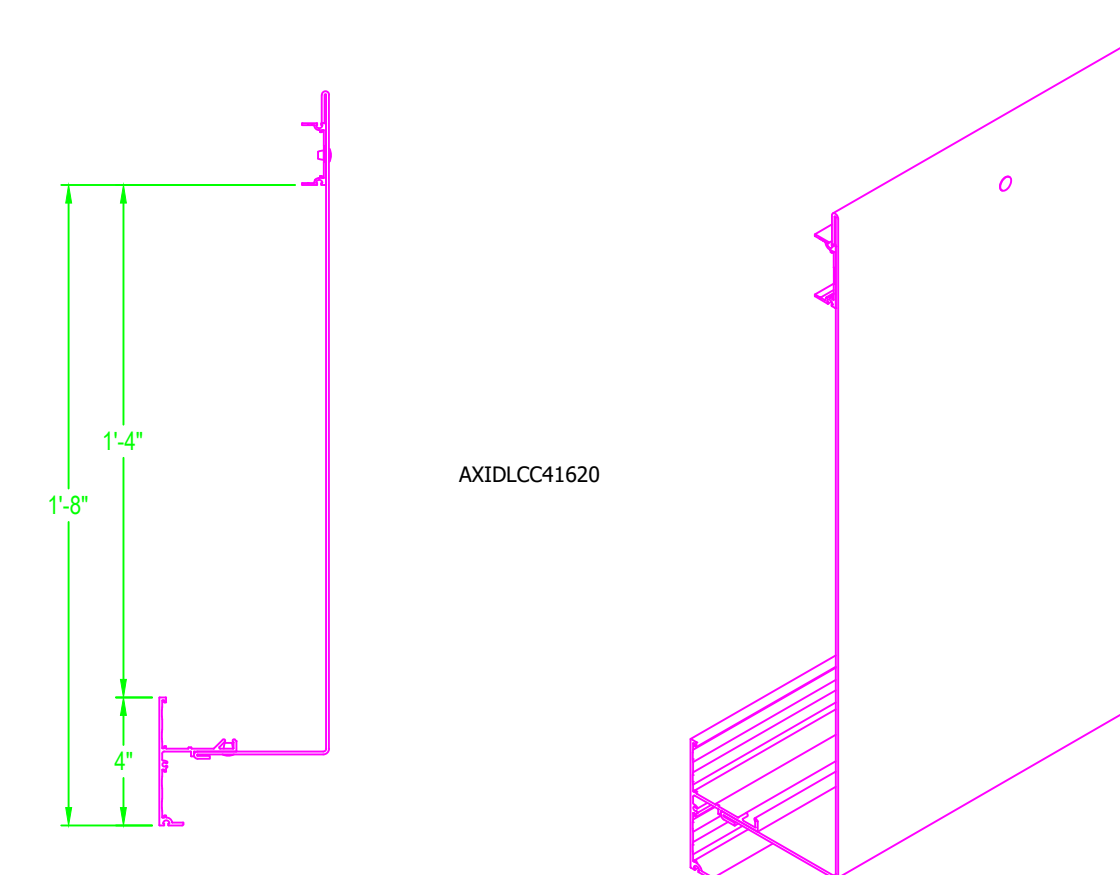

AXIDLCC41620

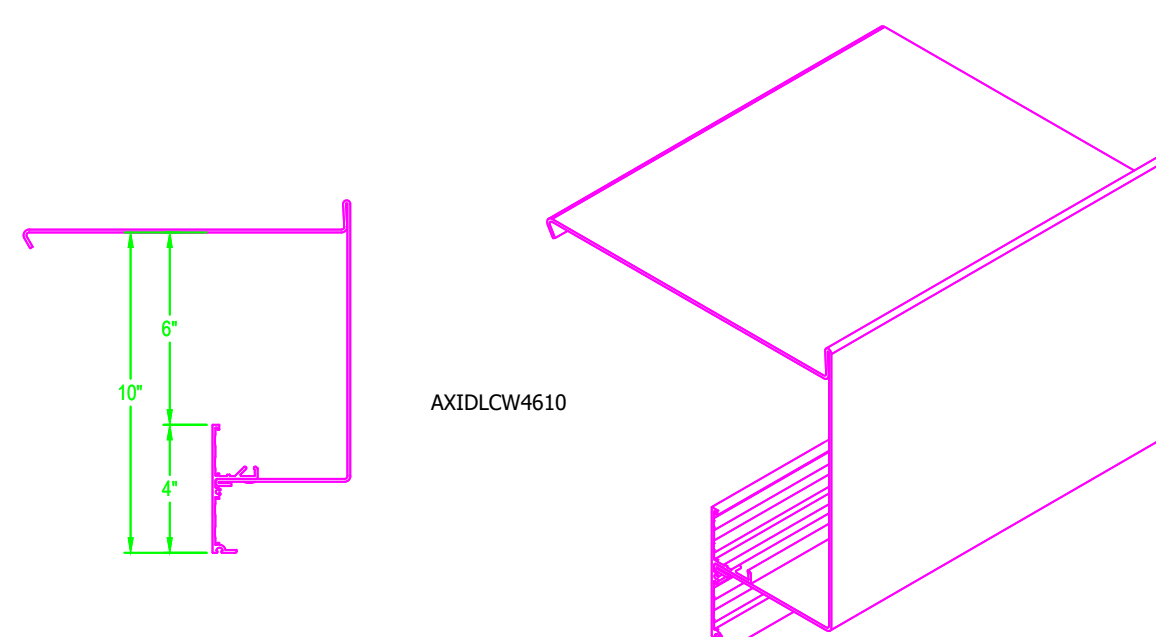

AXIDLW4610

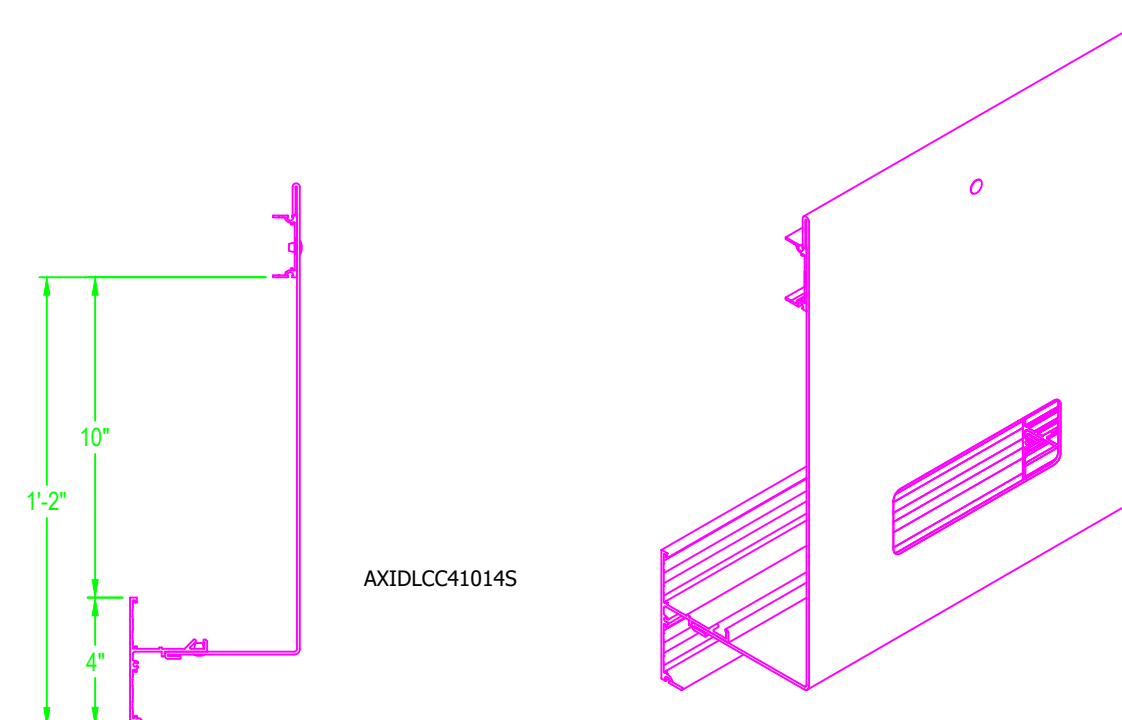

AXIDLCC41014S

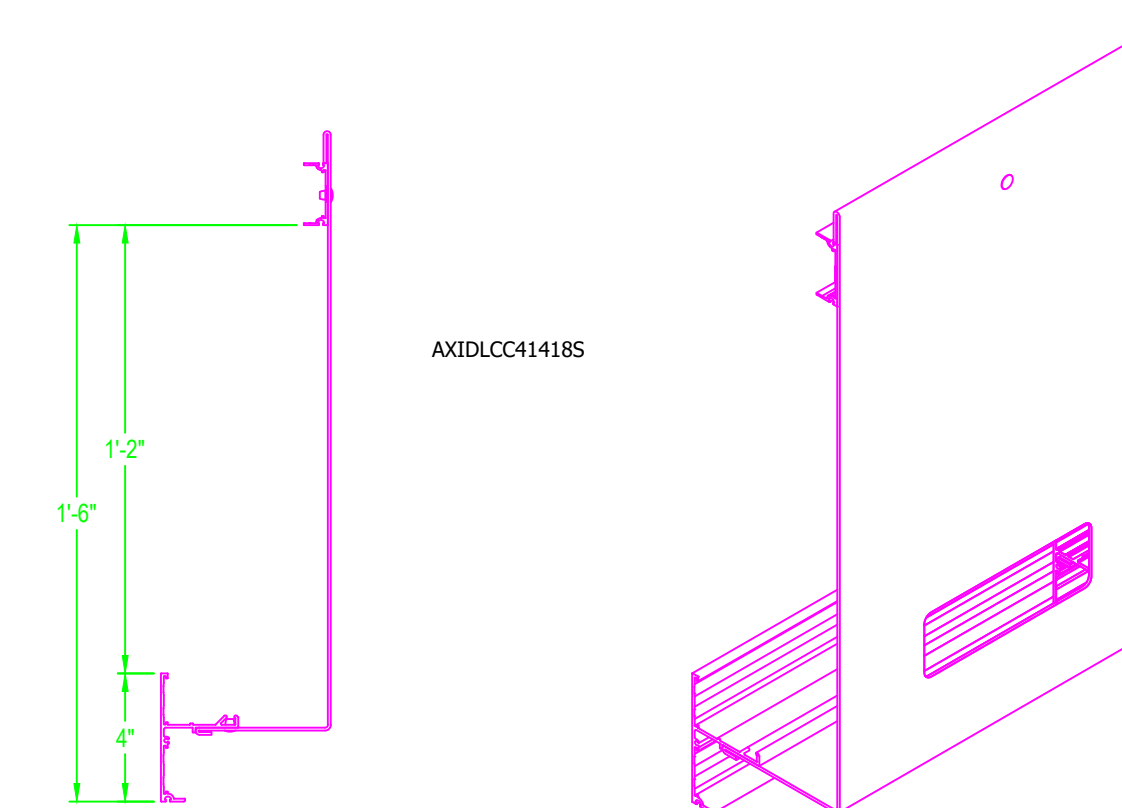

AXIDLCC41418S

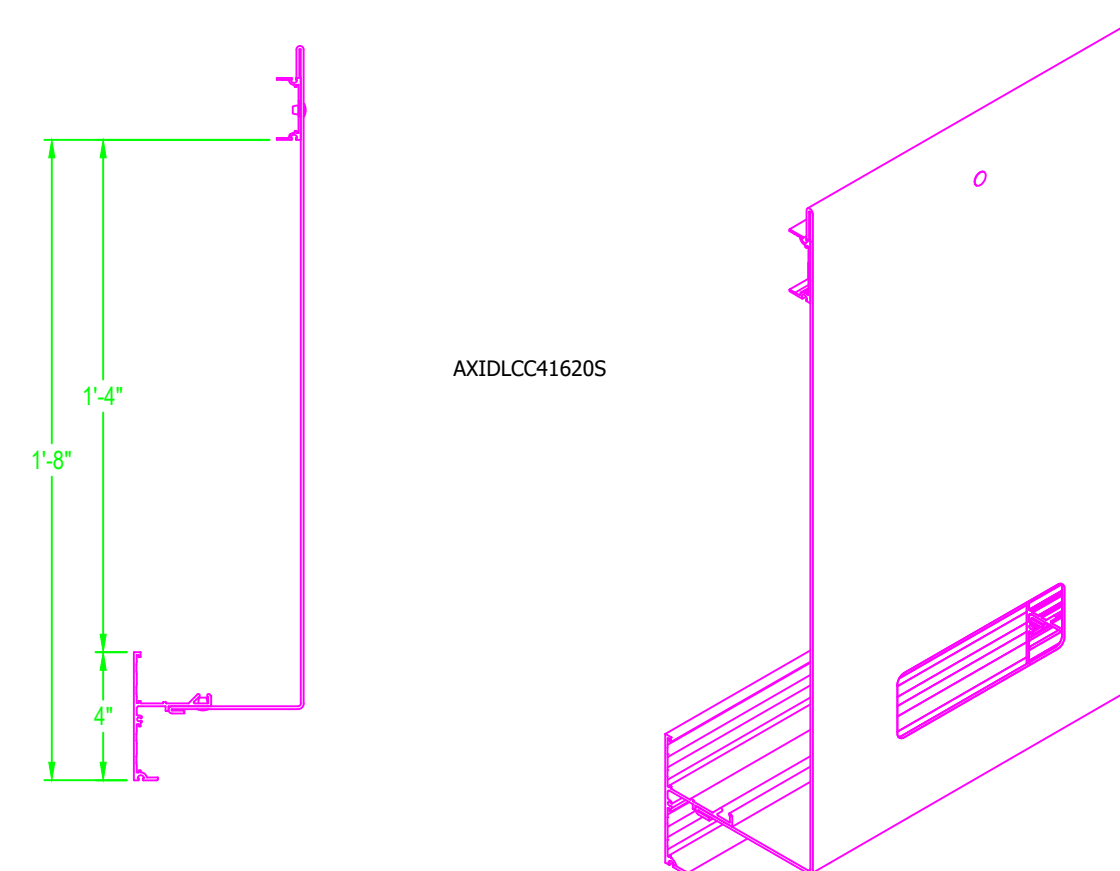

AXIDLCC41620S

<p>These drawings show typical conditions in which the Armstrong product depicted is installed. They are not a substitute for an architect's or engineer's plan and do not reflect the unique requirements of local building codes, laws, ordinances, rules and regulations (Legal Requirements) that may be applicable for a particular installation.</p> <p>Armstrong does not warrant, and assumes no liability for the accuracy or completeness of the drawings for a particular installation or their fitness for a particular purpose. The user is advised to consult with a duly licensed architect or engineer in the particular locale of the installation to assure compliance with all Legal Requirements.</p> <p>Armstrong is not licensed to provide professional architecture or engineering design services.</p>		<p>PROJECT NAME: INDIRECT LIGHT COVE MASTER SHEET</p>	
DWG. NO. CLASSIC	DATE: 6/29/23	SCALE:	REV: . . . DATE: . . .
DRAWN BY: MAP	CHK BY:	DESC: . . .	
<p>Techn ARMSTRONG CEILING SYSTEMS * ARMSTRONG WORLD INDUSTRIES, INC. * Lancaster, PA * Phone: 877-ARMSTRONG</p>			

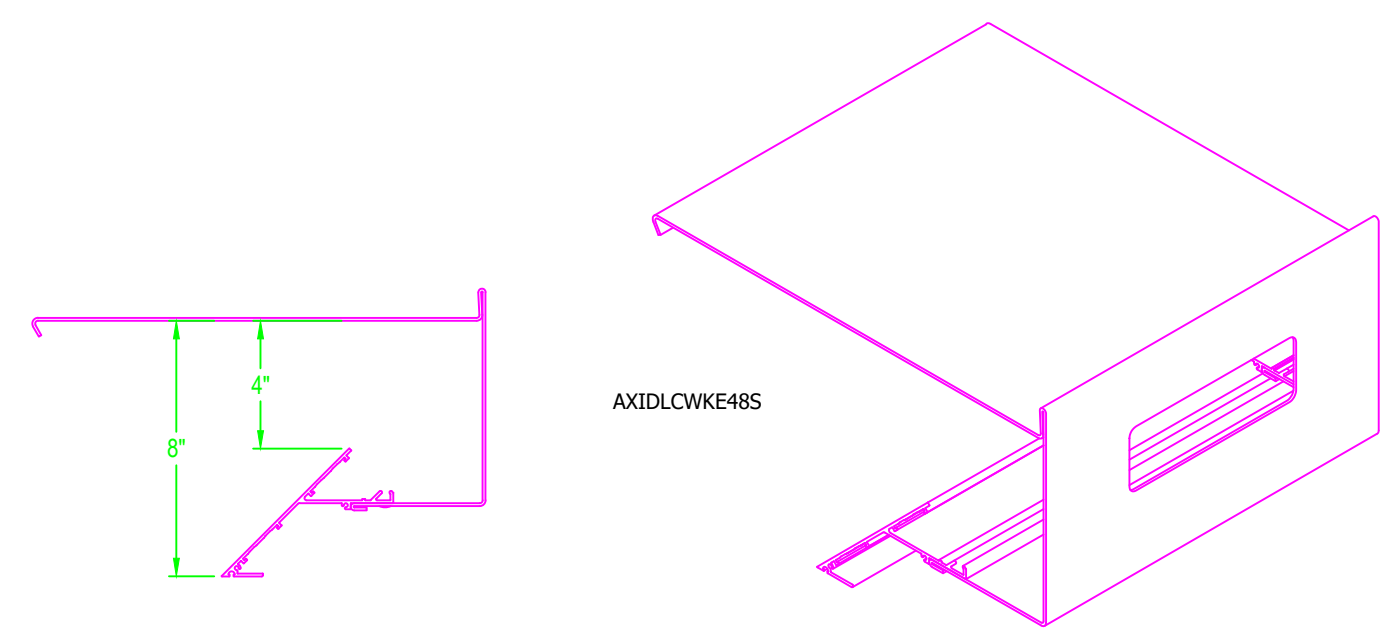

AXIDLWKE48S

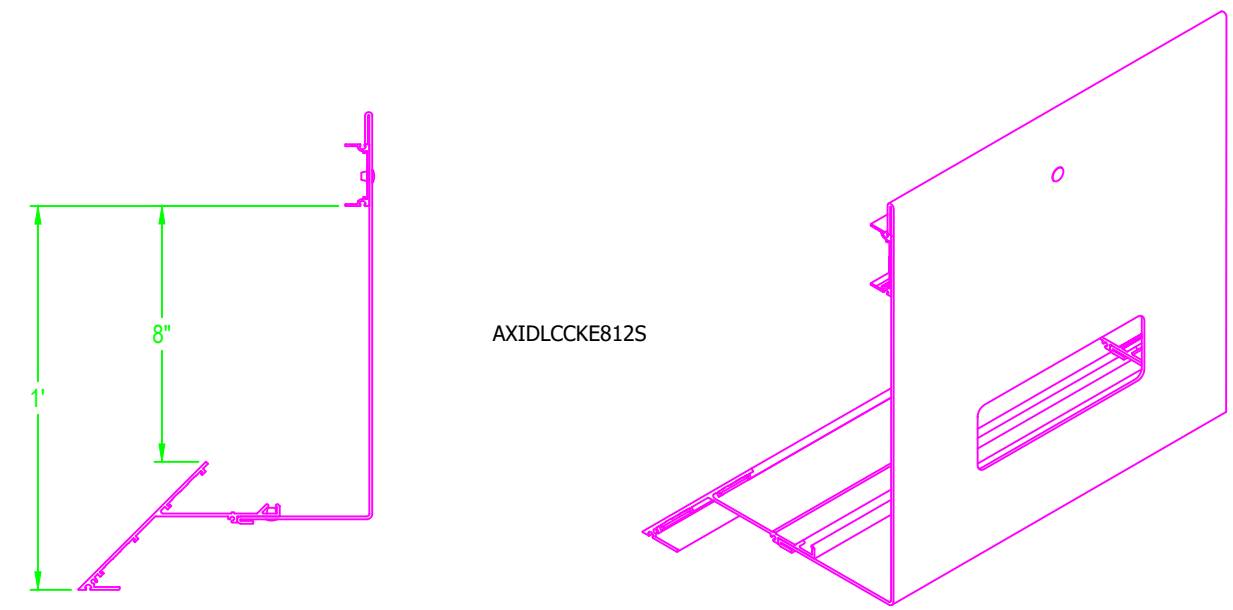

AXIDLCKE125

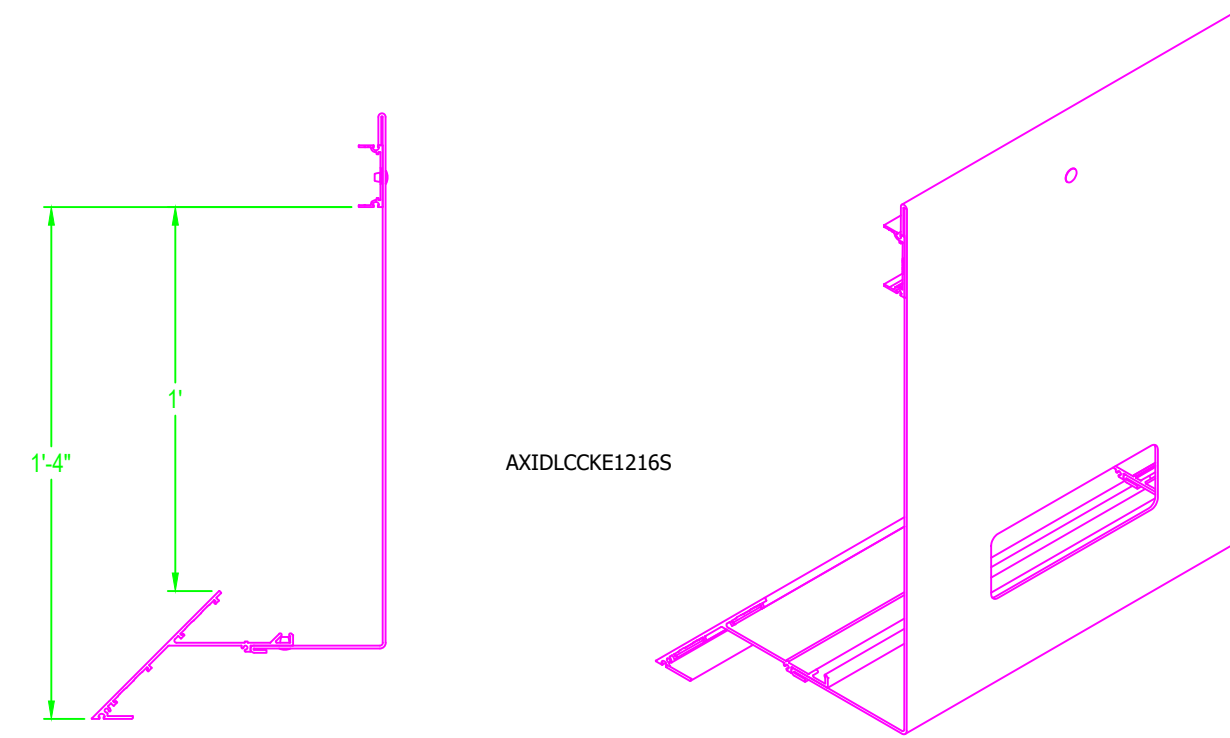

AXIDLCKE1216S

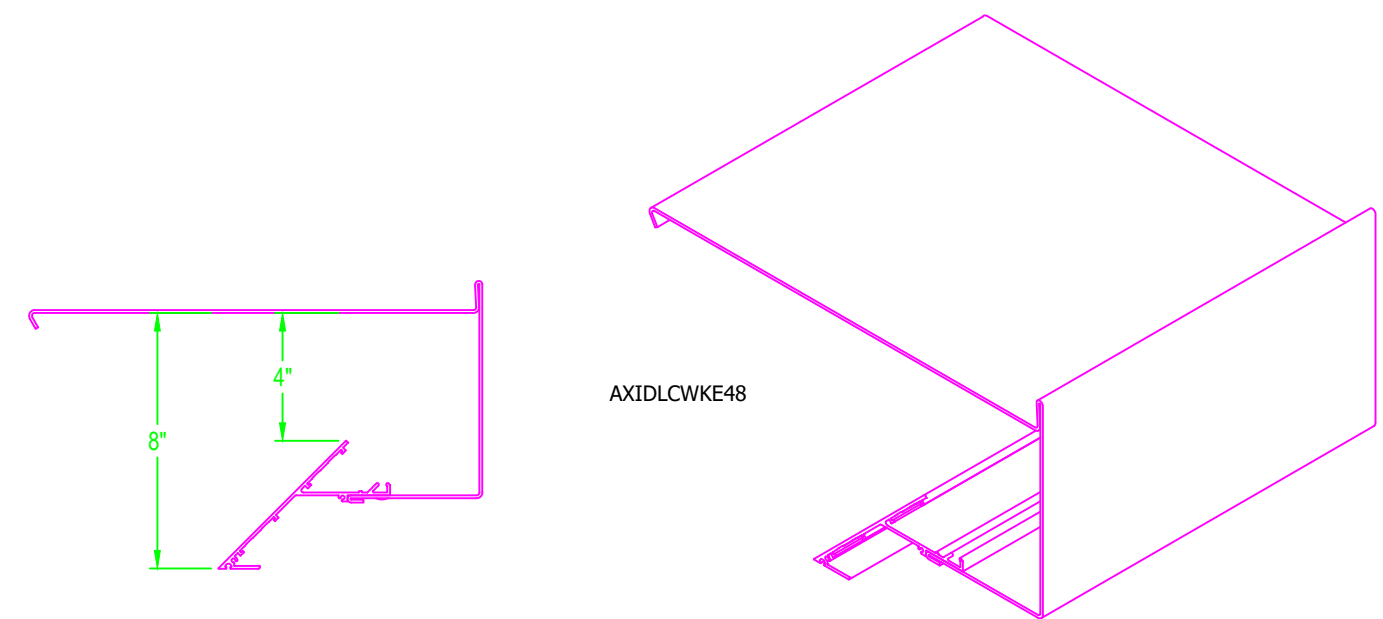
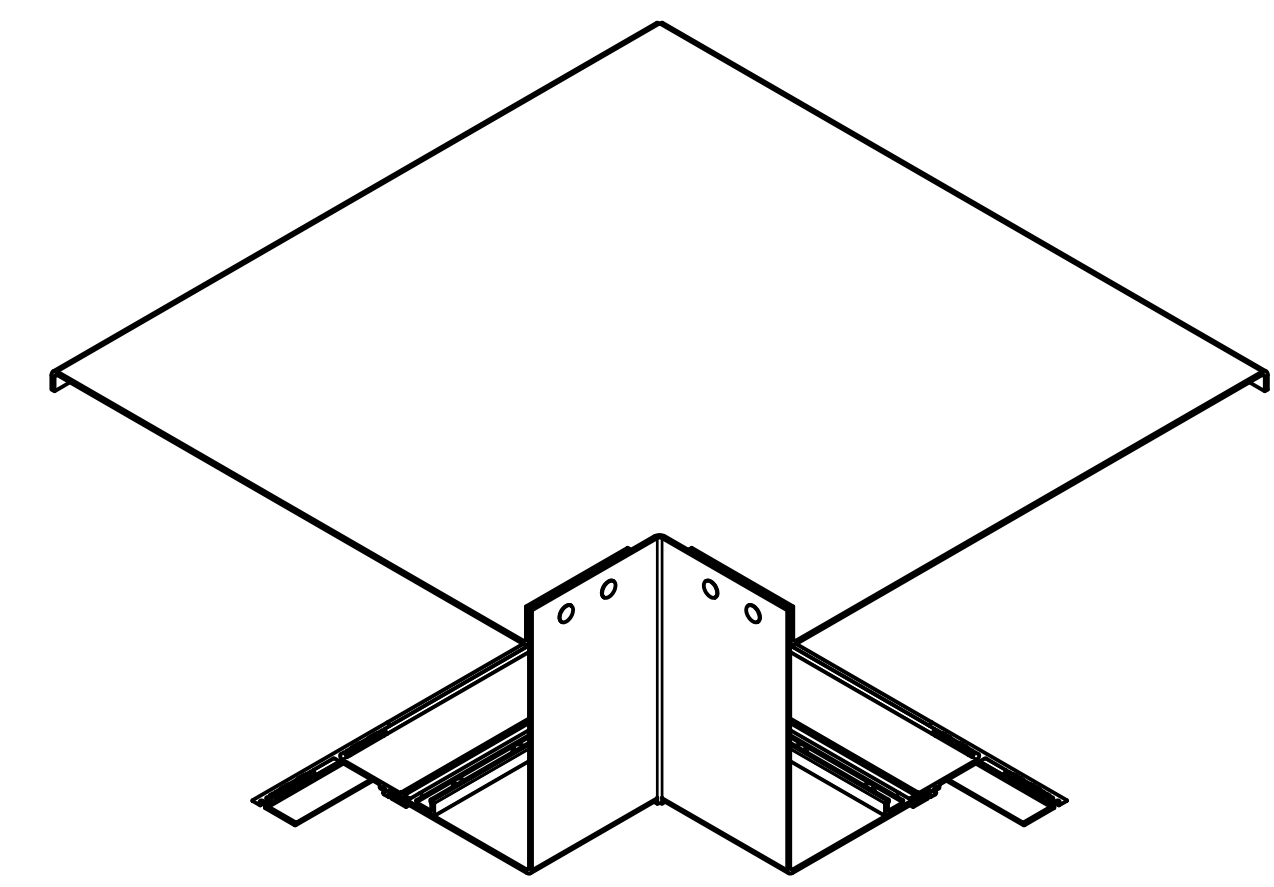

AXIDLWKE48

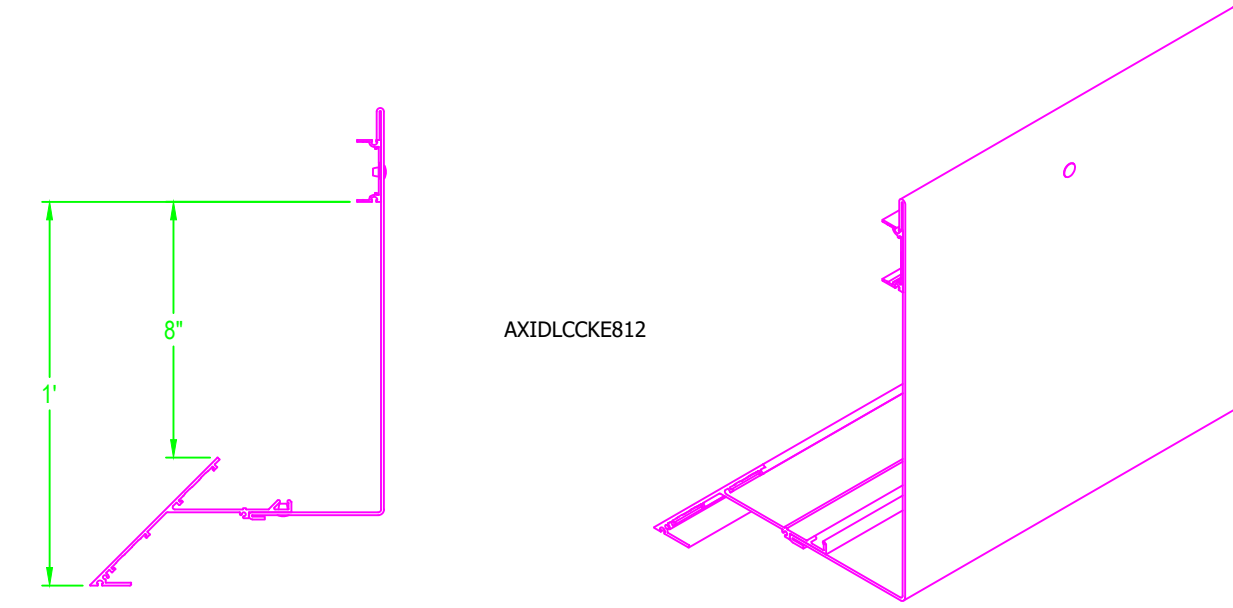

AXIDLCKE12

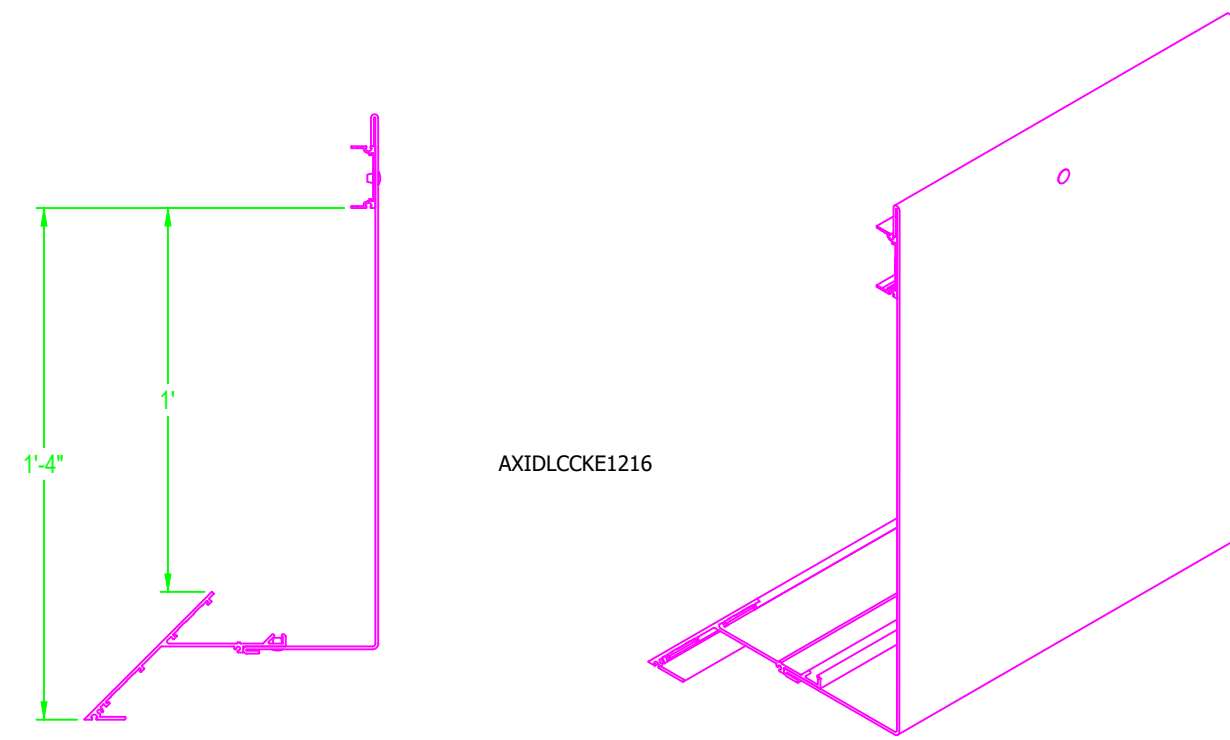

AXIDLCKE1216

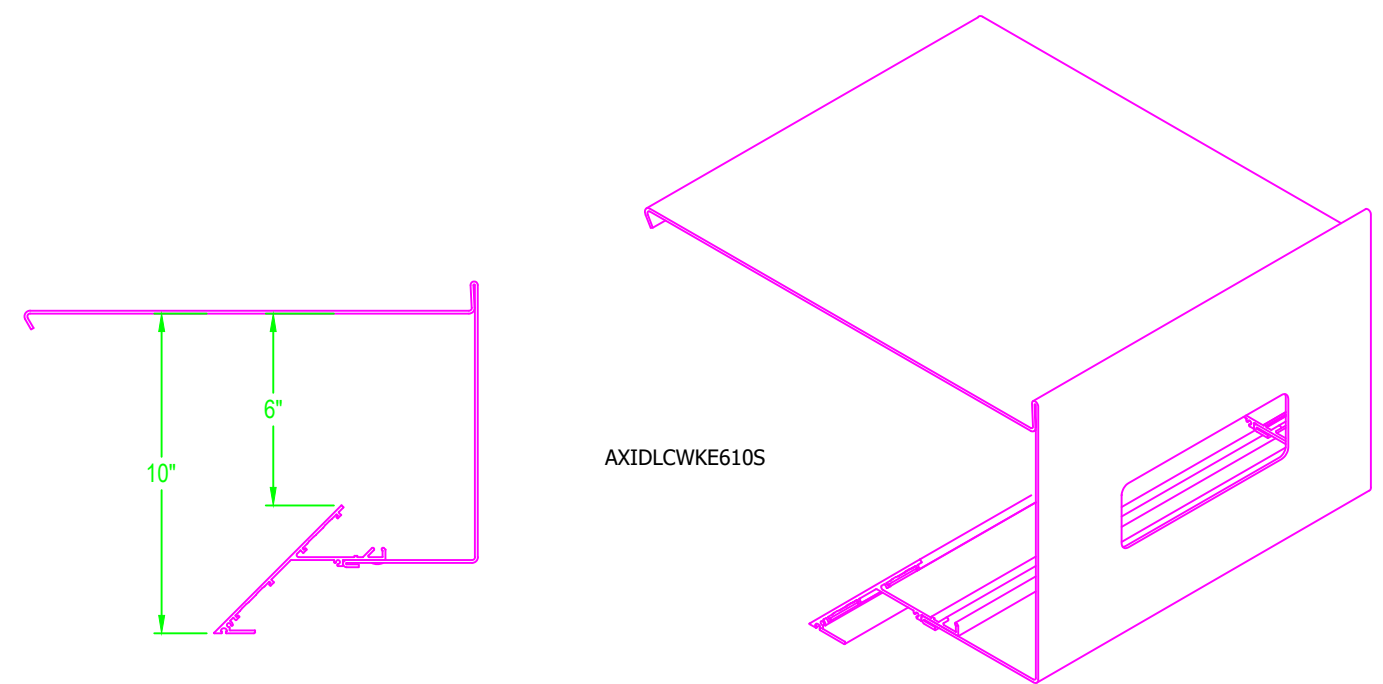
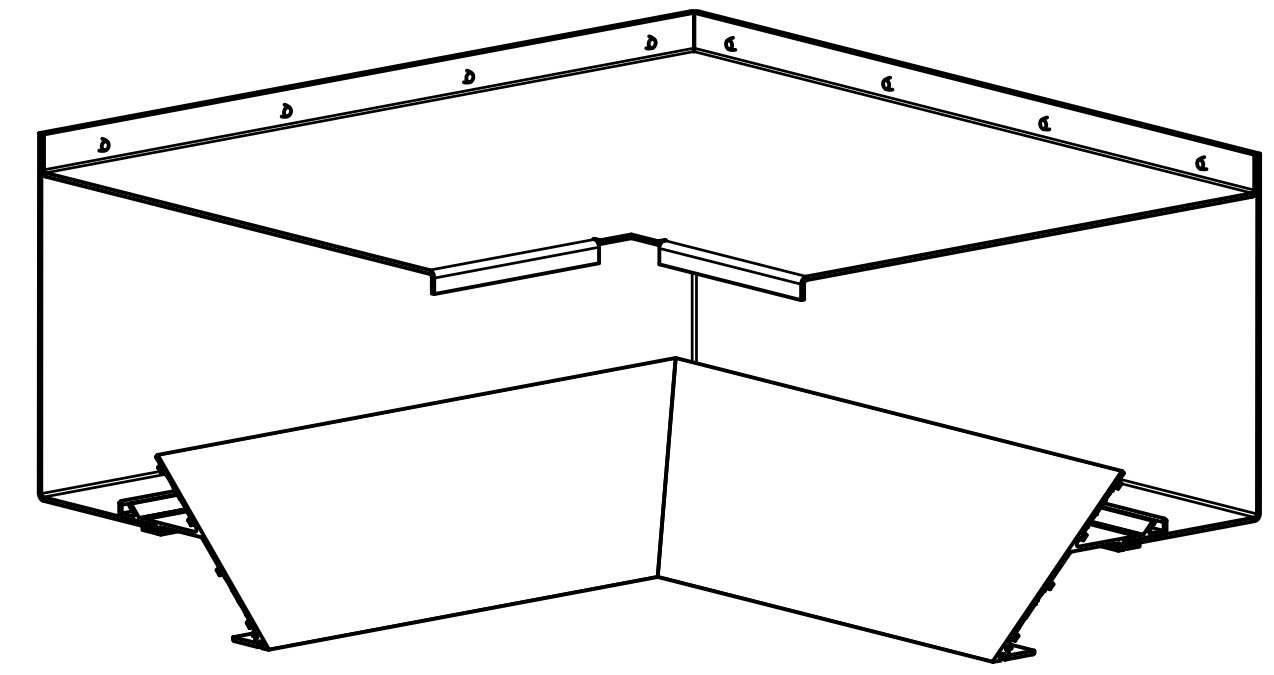

AXIDLWKE610S

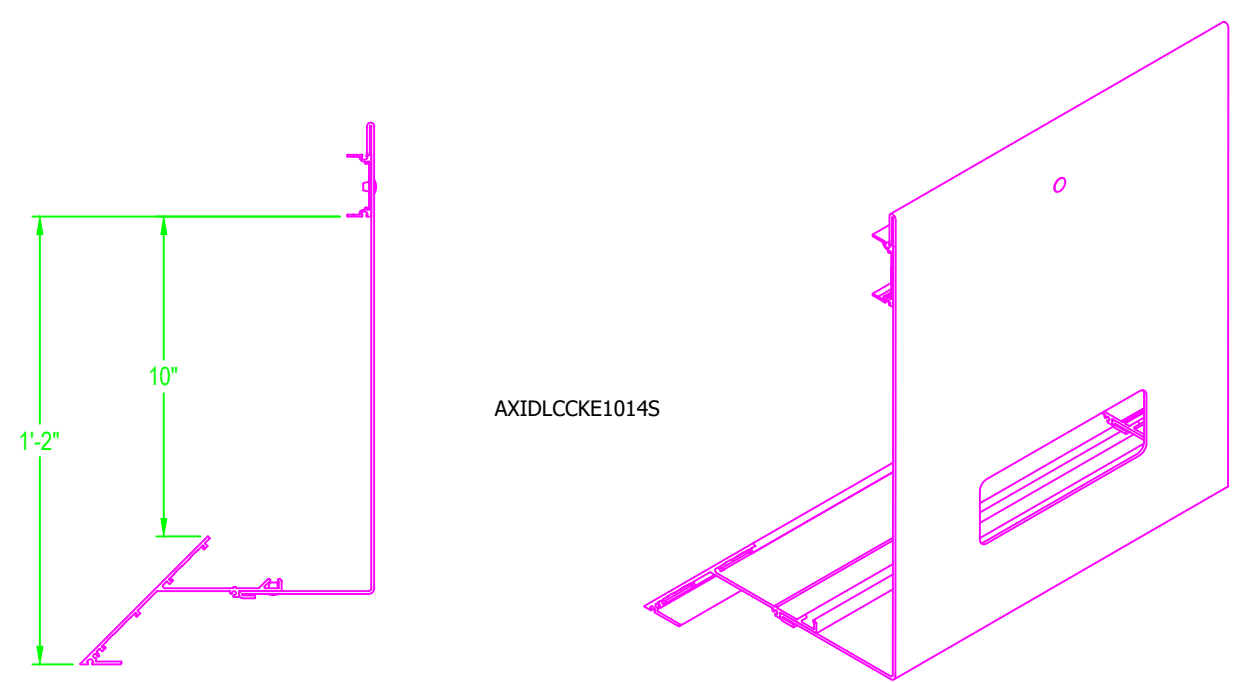

AXIDLCKE1014S

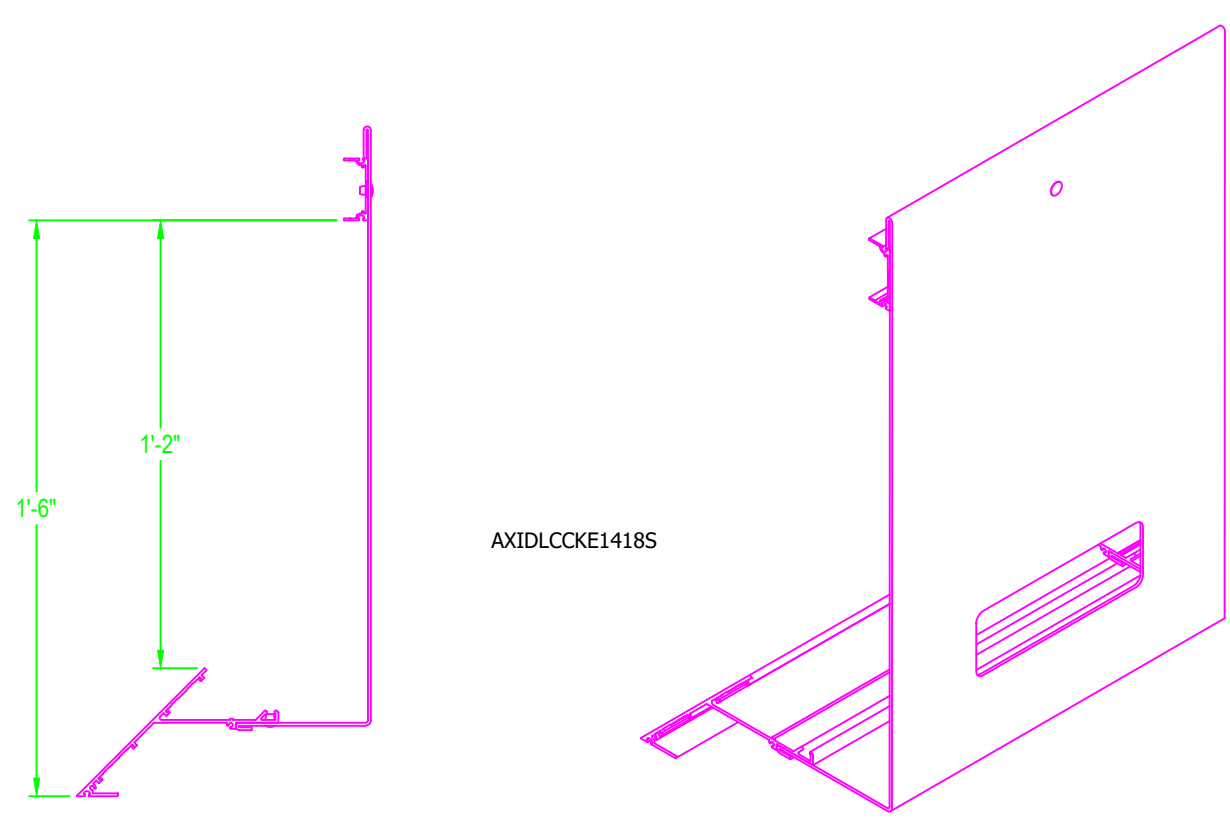

AXIDLCKE1418S

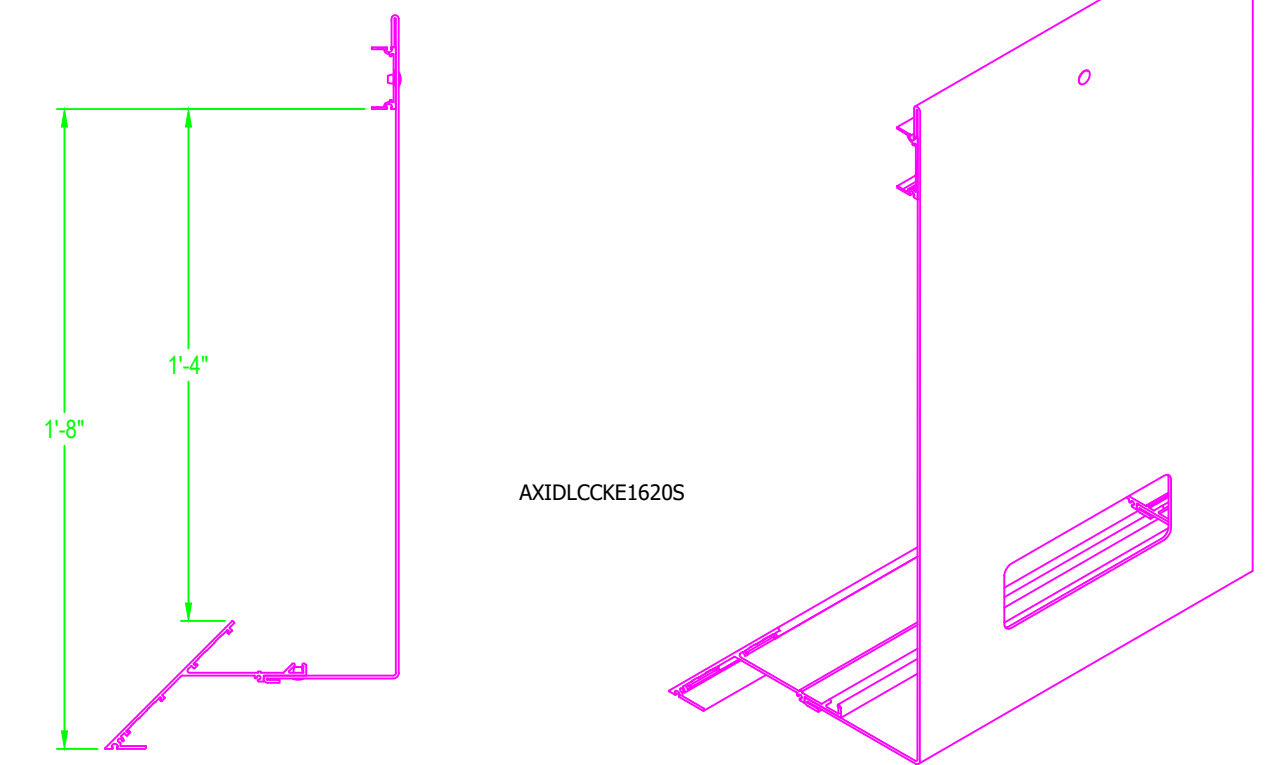

AXIDLCKE1620S

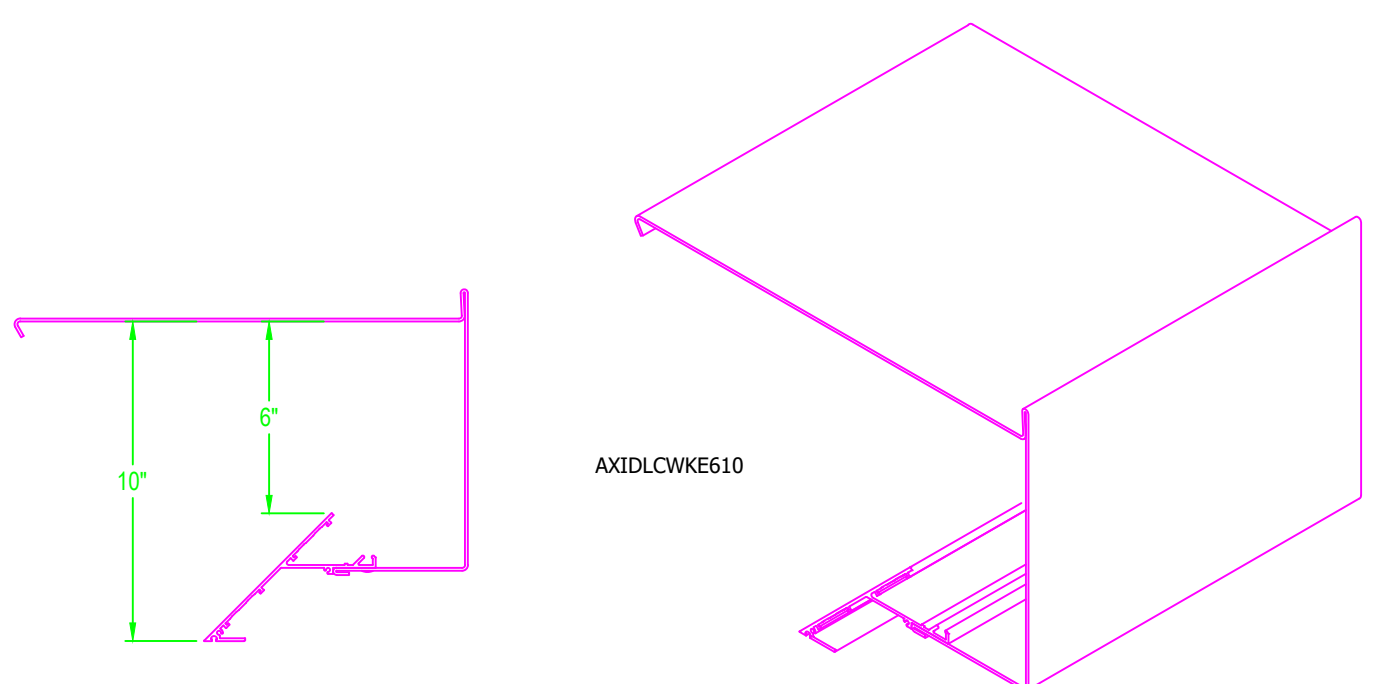

AXIDLWKE610

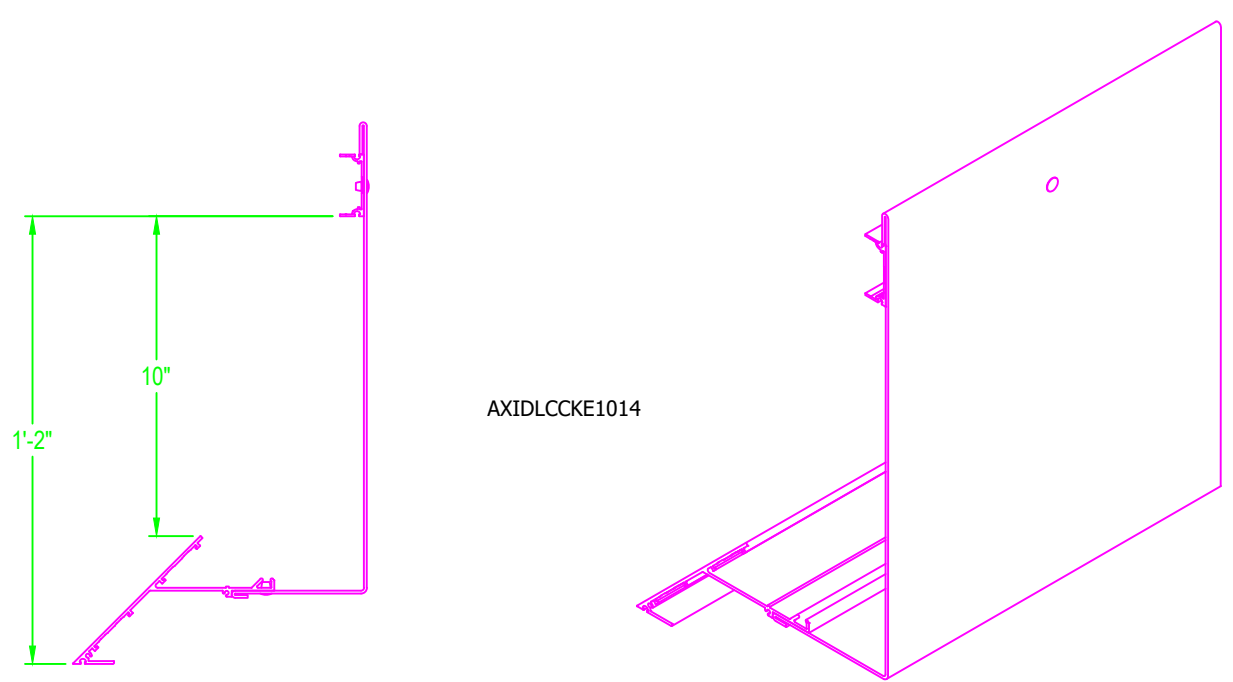

AXIDLCKE1014

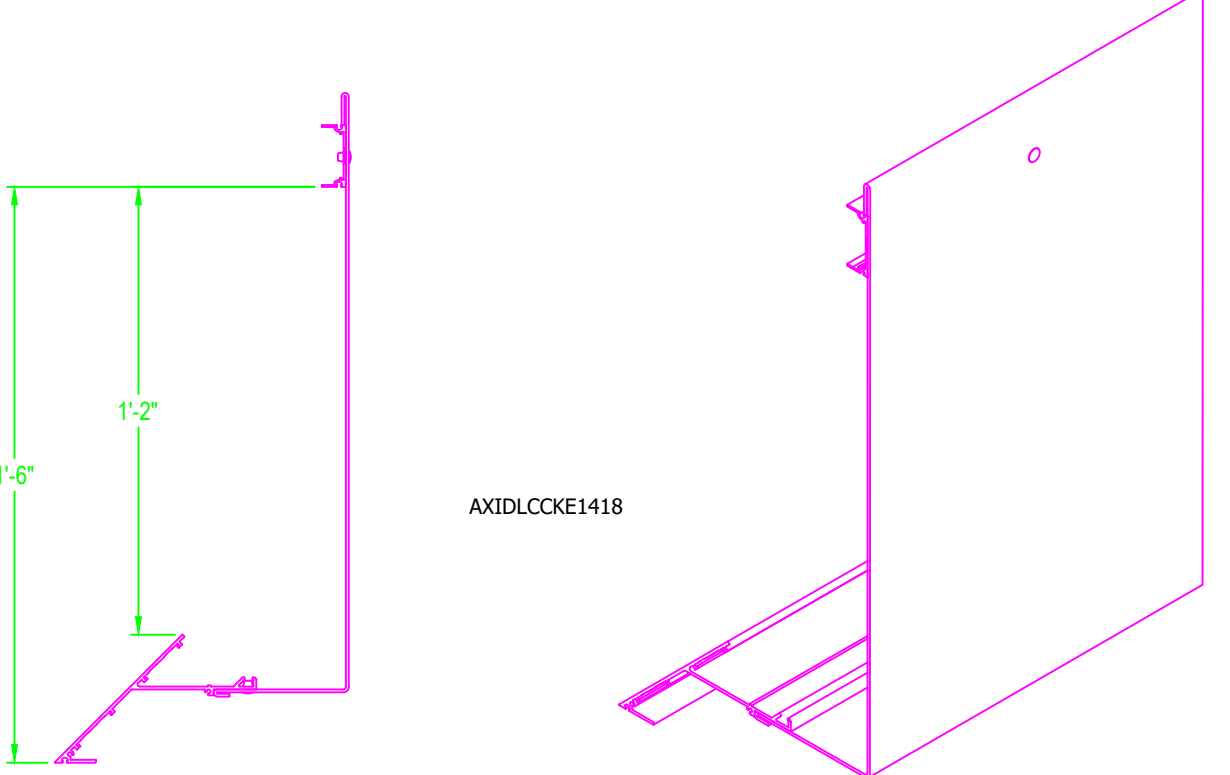

AXIDLCKE1418

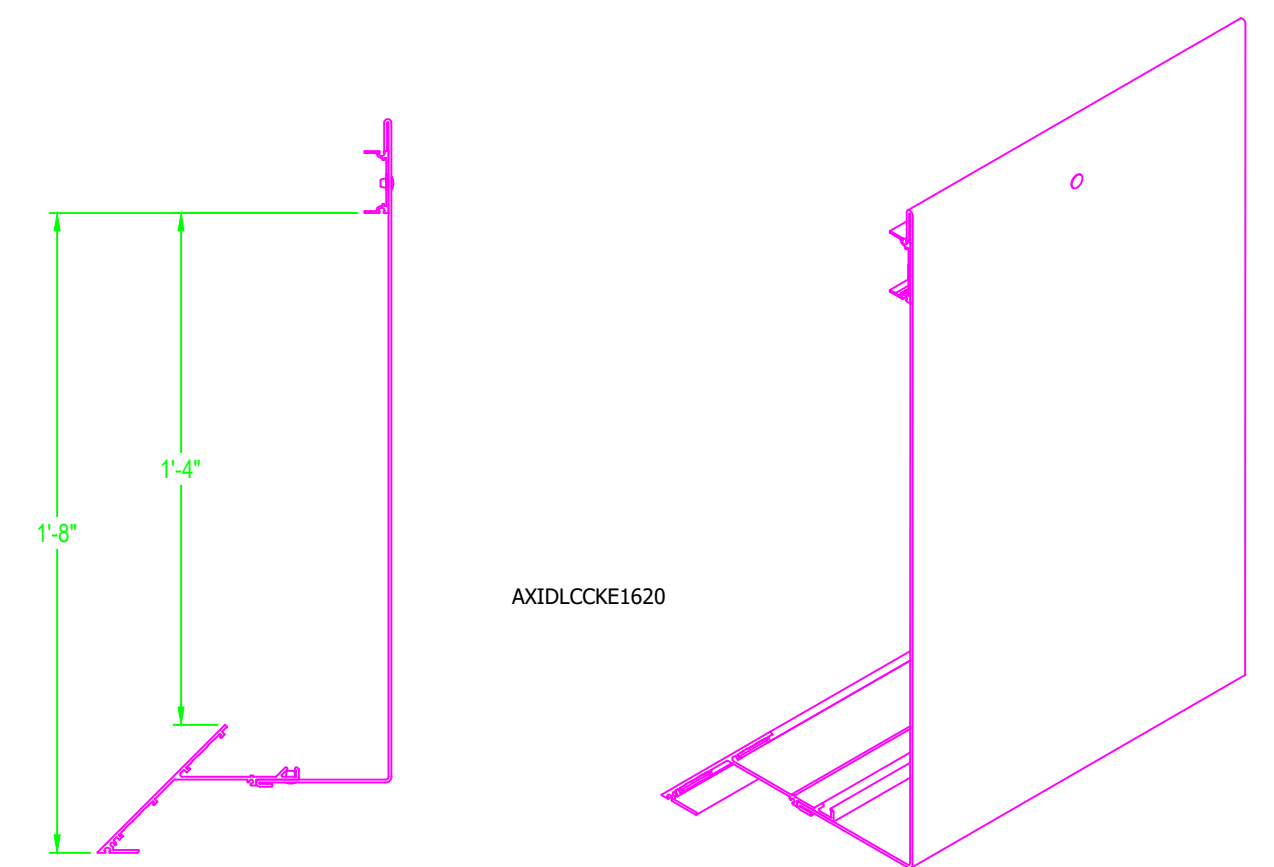

AXIDLCKE1620

<p>These drawings show typical conditions in which the Armstrong product depicted is installed. They are not a substitute for an architect's or engineer's plan and do not reflect the unique requirements of local building codes, laws, ordinances, rules and regulations (Legal Requirements) that may be applicable for a particular installation.</p> <p>Armstrong does not warrant, and assumes no liability for the accuracy or completeness of the drawings for a particular installation or their fitness for a particular purpose. The user is advised to consult with a duly licensed architect or engineer in the particular locale of the installation to assure compliance with all Legal Requirements.</p> <p>Armstrong is not licensed to provide professional architecture or engineering design services.</p>		<p>PROJECT NAME: INDIRECT LIGHT COVE MASTER SHEET</p>	
DWG. NO. KNIFE-EDGE	DATE: 6/29/23	SCALE:	REV: . . DATE: . .
DRAWN BY: MAP	CHK BY:	DESC: . .	
<p>Techn ARMSTRONG CEILING SYSTEMS * ARMSTRONG WORLD INDUSTRIES, INC. * Lancaster, PA * Phone: 877-ARMSTRONG</p>		<p>Amstrong</p>	

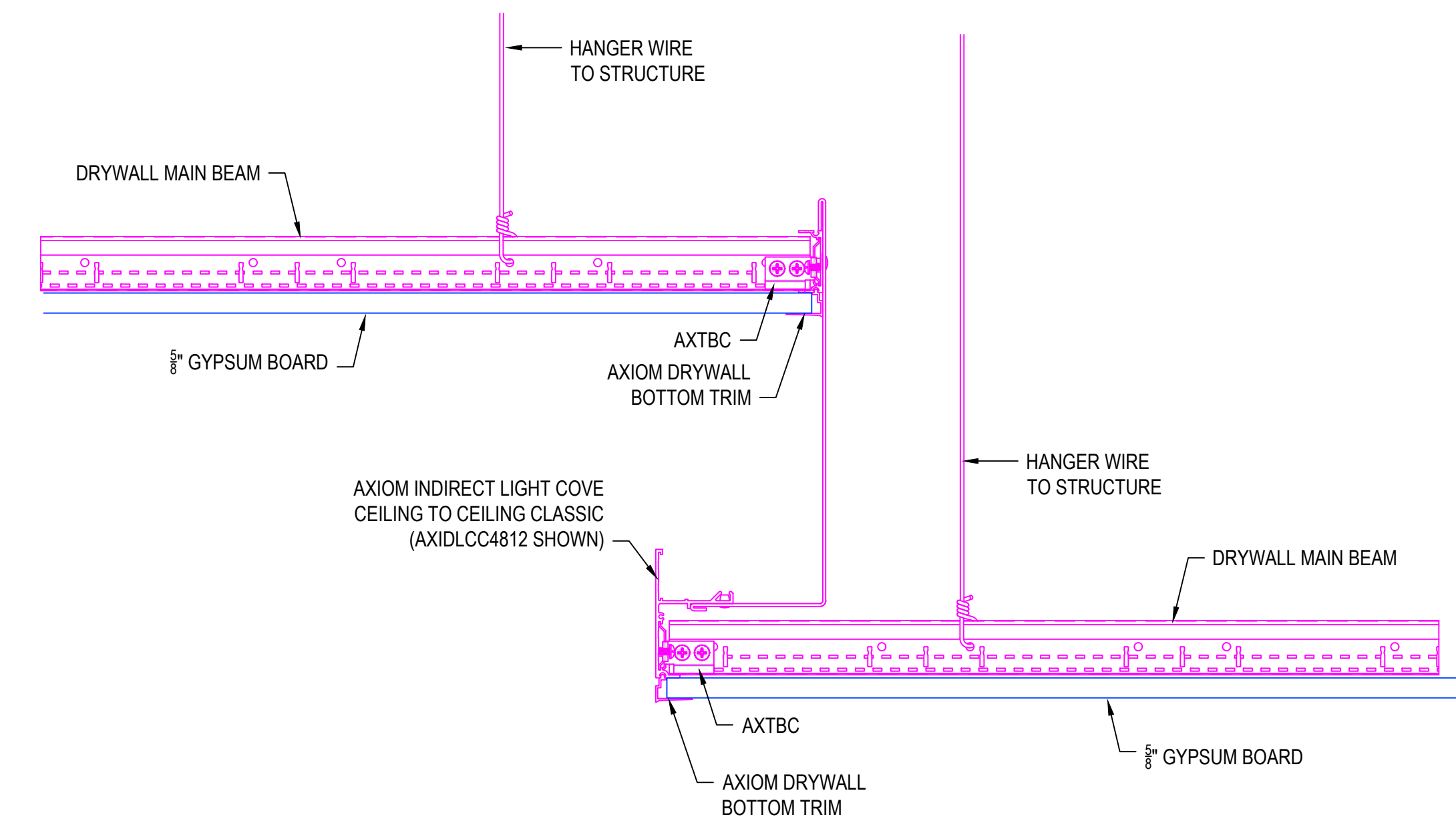
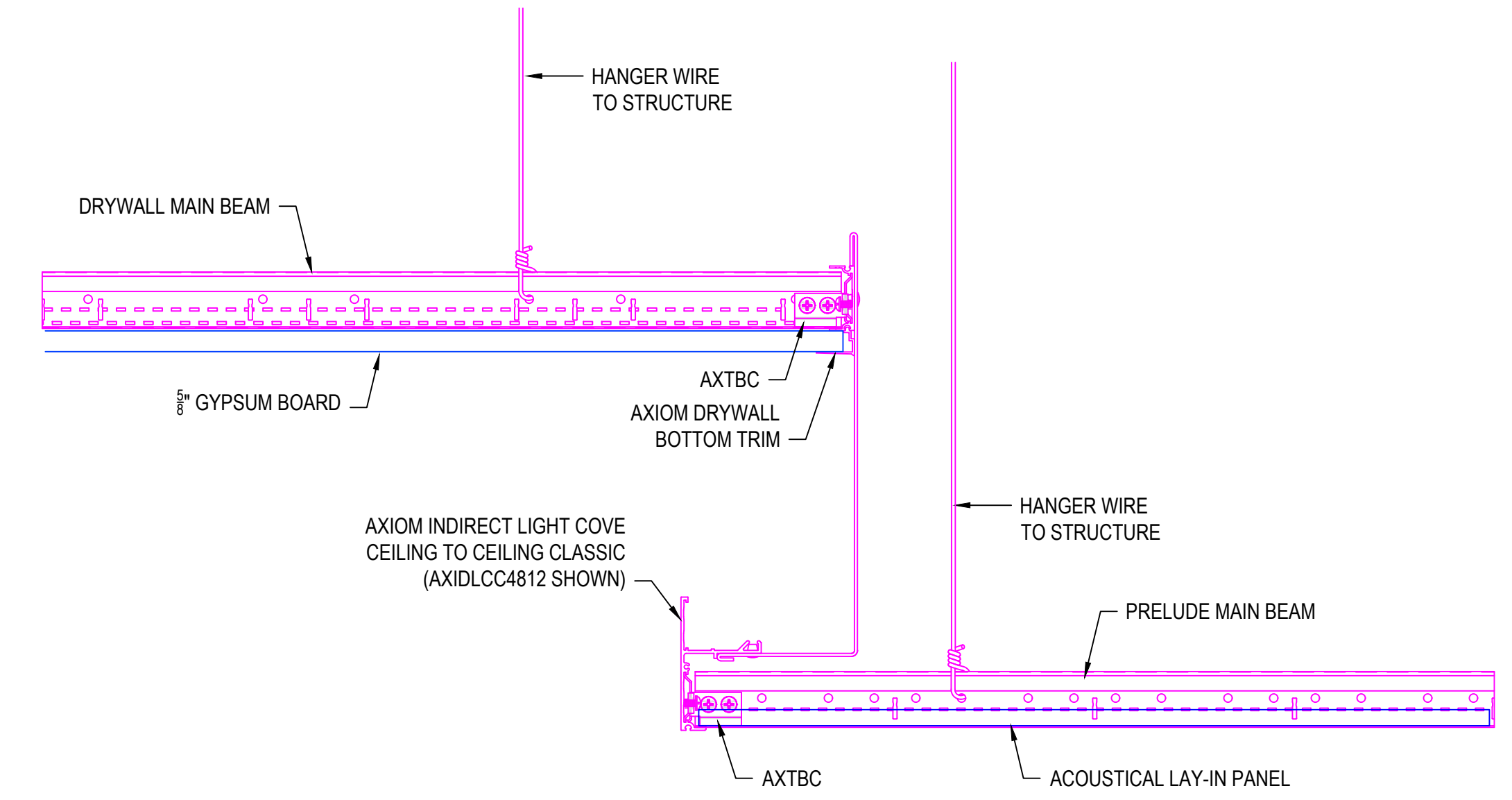
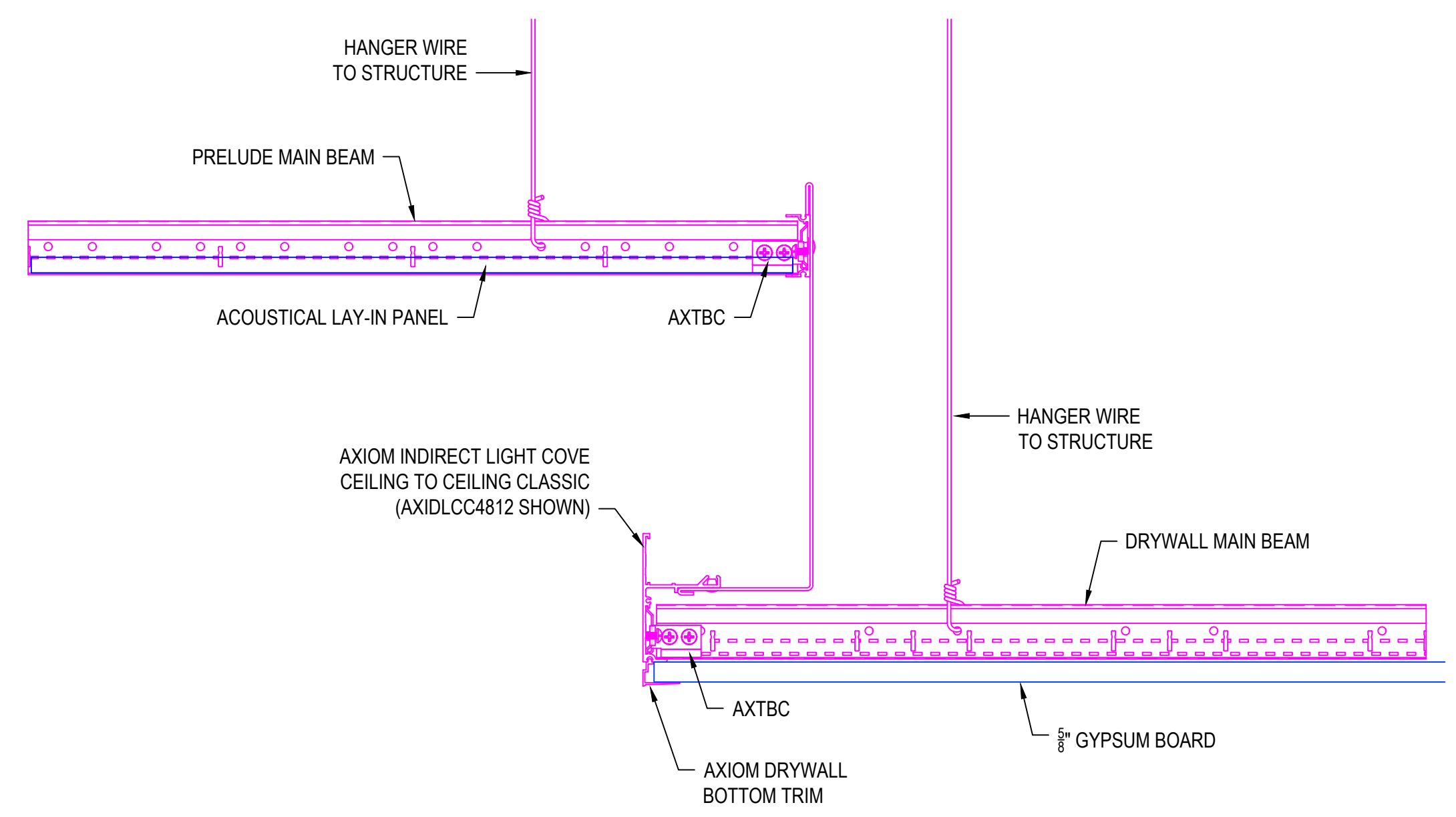
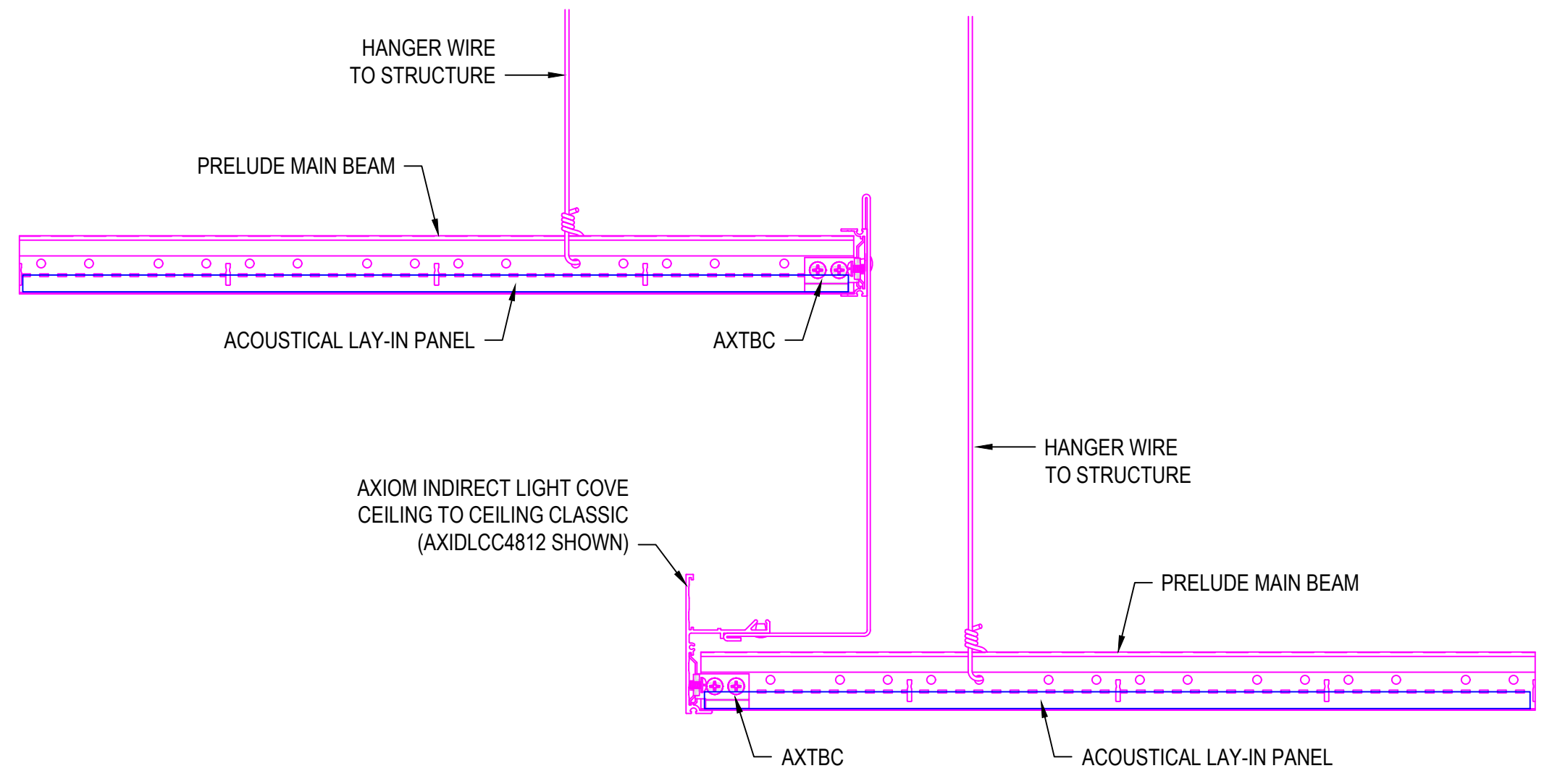
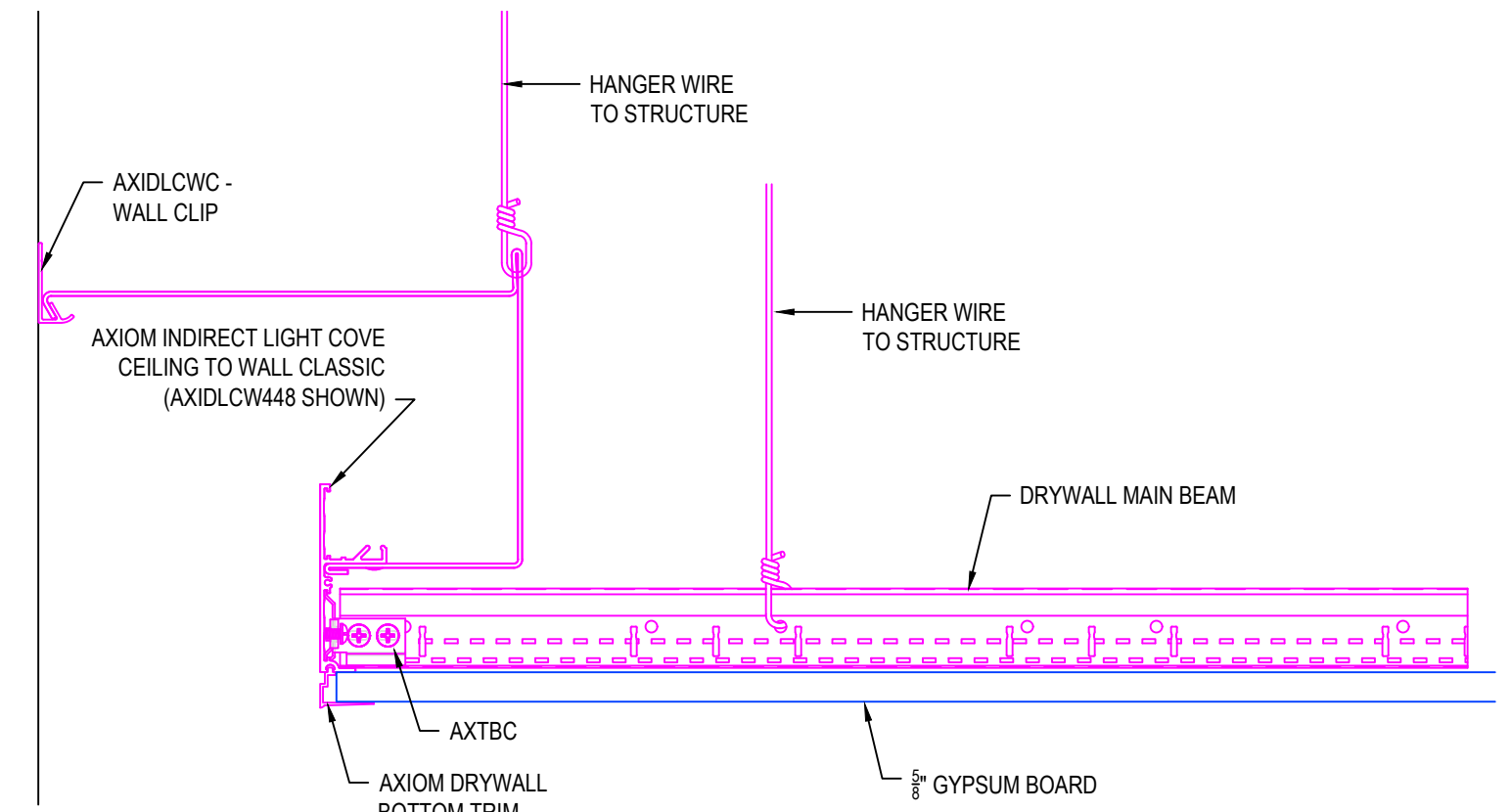
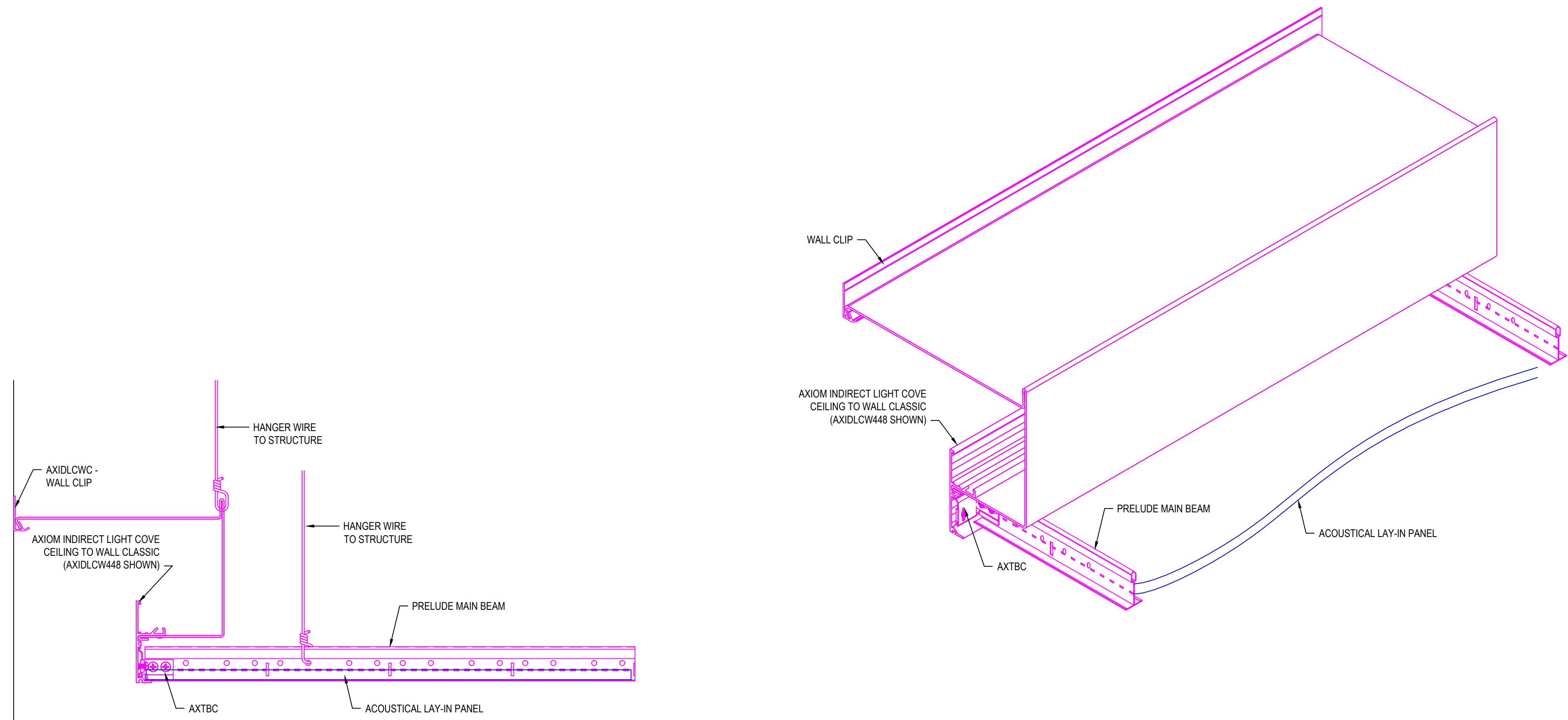

These drawings show typical conditions in which the Armstrong product depicted is installed. They are not a substitute for an architect or engineer's plan and do not reflect the unique requirements of local building codes, laws, ordinances, rules and regulations (Legal Requirements) that may be applicable for a particular installation.

Armstrong does not warrant, and assumes no liability for the accuracy or completeness of the drawings for a particular installation or their fitness for a particular purpose. The user is advised to consult with a duly licensed architect or engineer in the particular locale of the installation to assure compliance with all Legal Requirements.

Armstrong is not licensed to provide professional architecture or engineering design services.

PROJECT NAME: INDIRECT LIGHT COVE MASTER SHEET		REV: .	DATE: .
DWG. NO. CLASSIC APPLICATIONS	SCALE:	DESC.:	
DATE: 6/29/23	CHK BY:		
DRAWN BY: MAP			

Techn ARMSTRONG CEILING SYSTEMS * ARMSTRONG WORLD INDUSTRIES, INC. * Lancaster, PA * Phone: 877-ARMSTRONG **Amstrong**

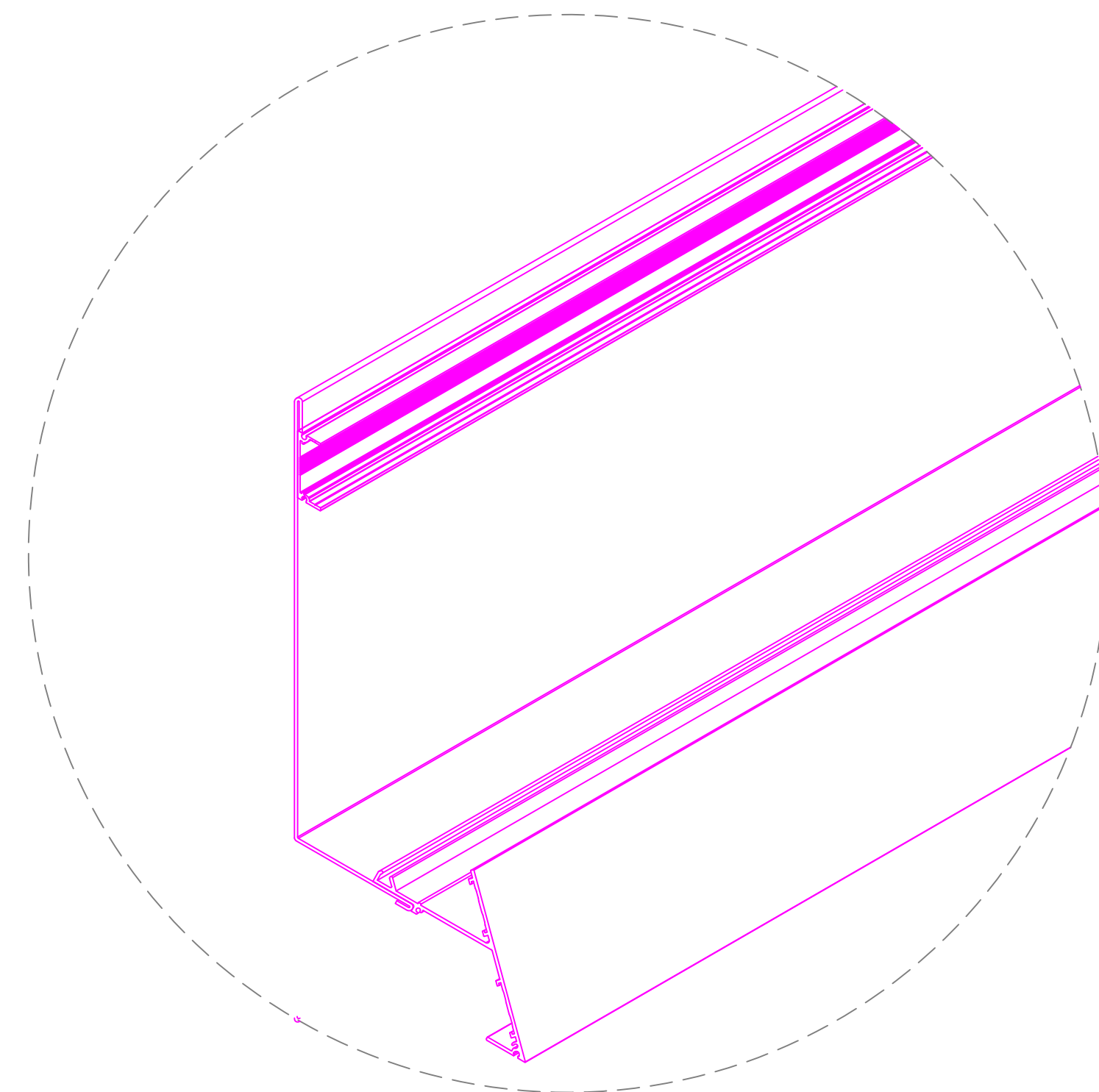
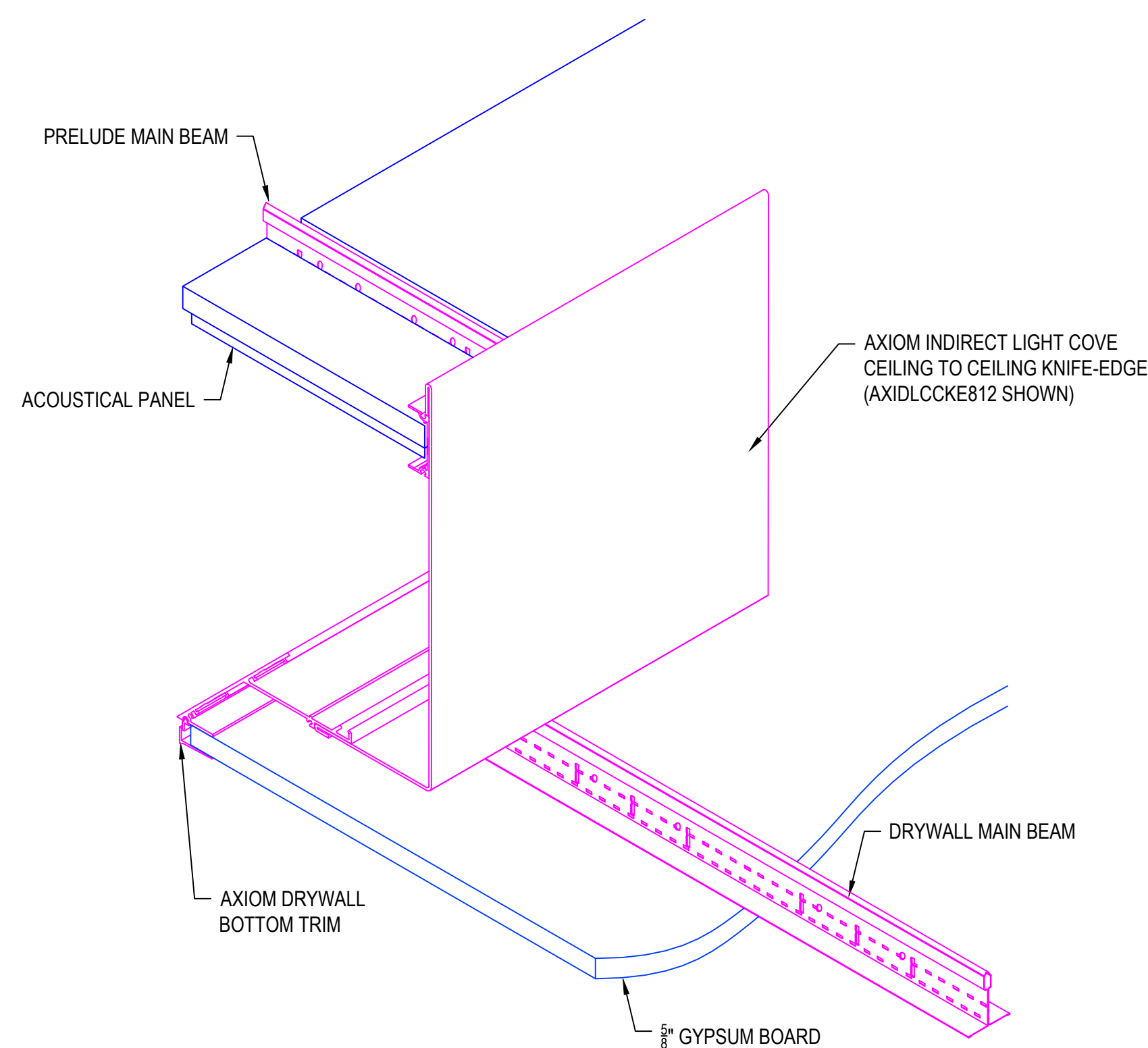
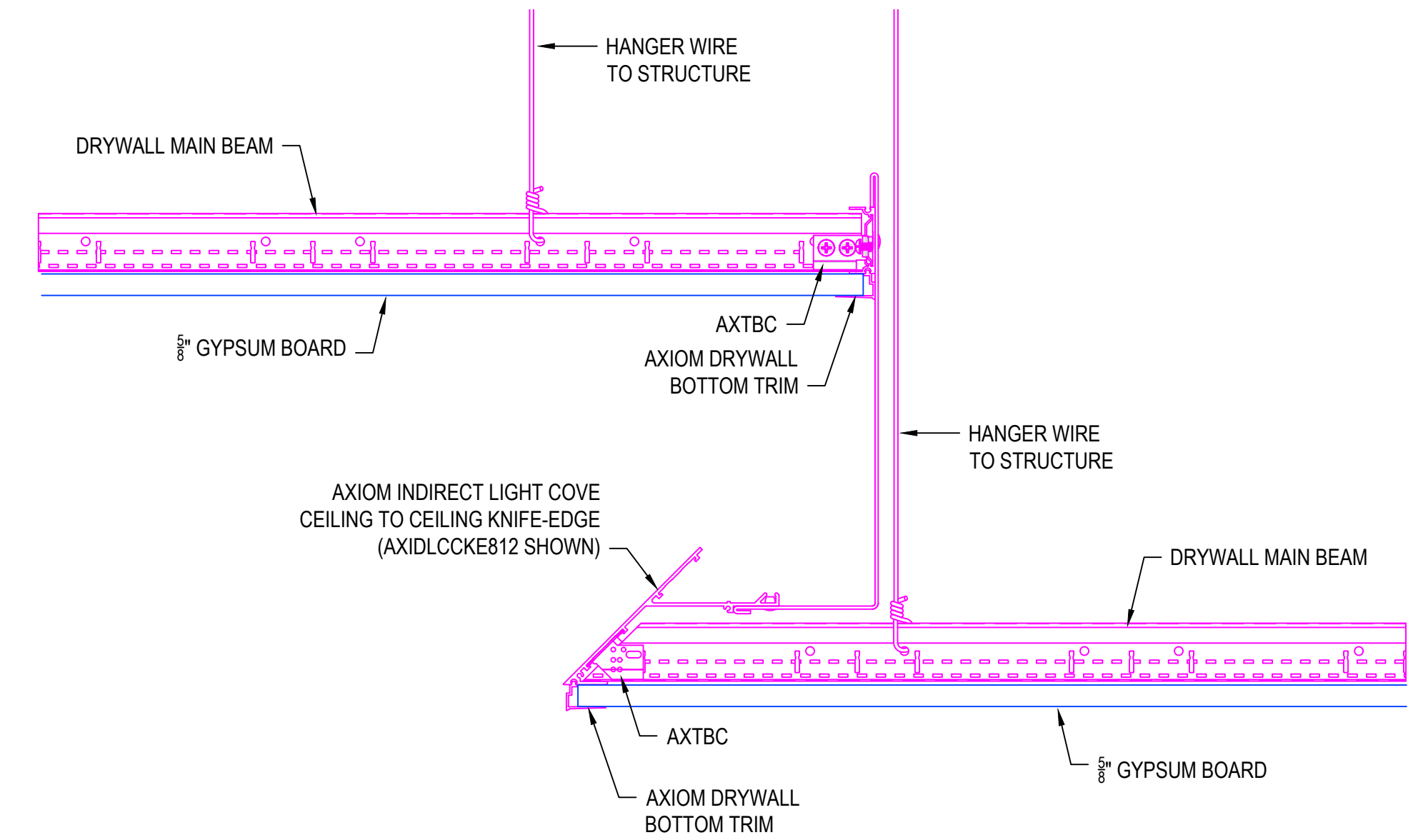
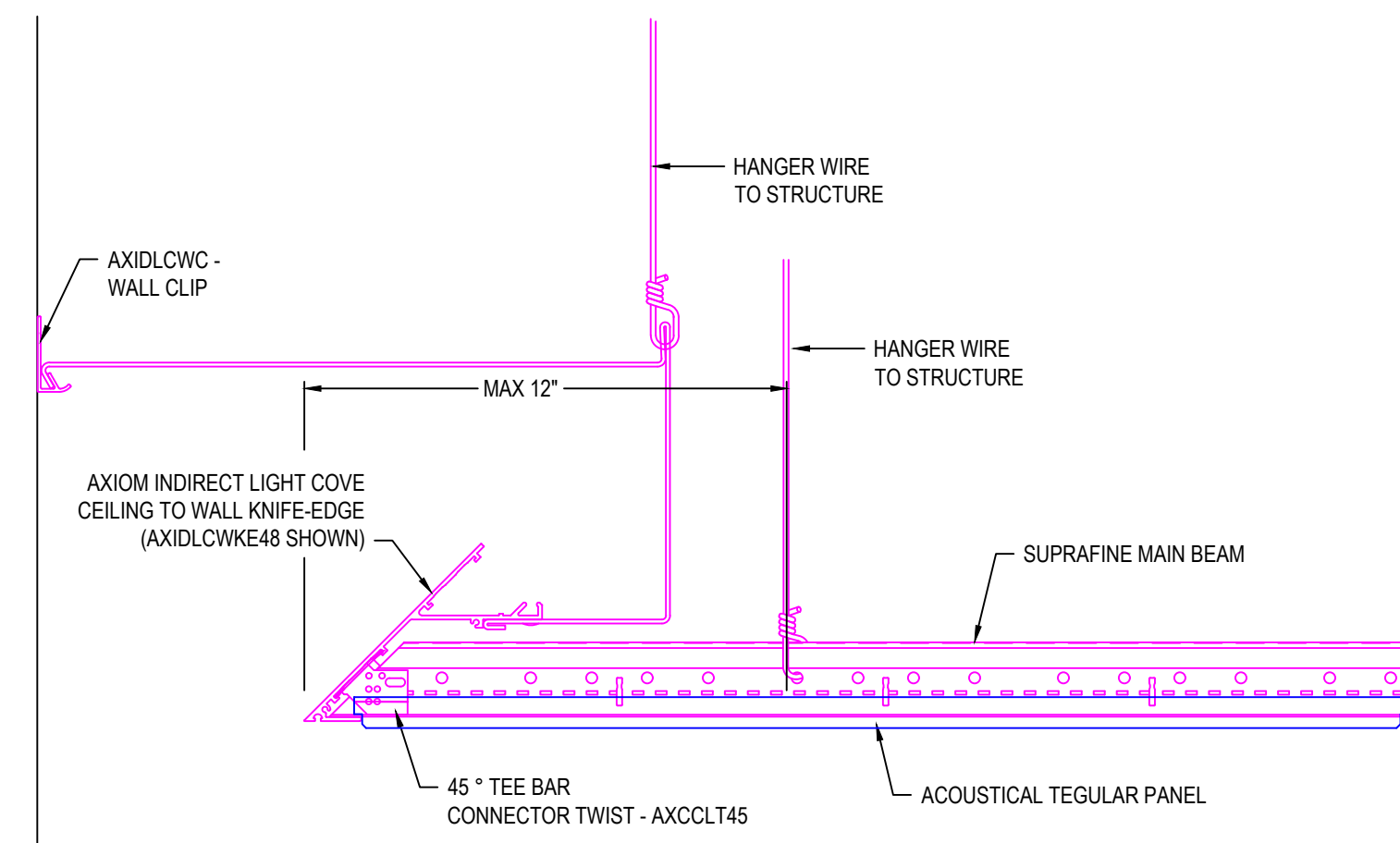
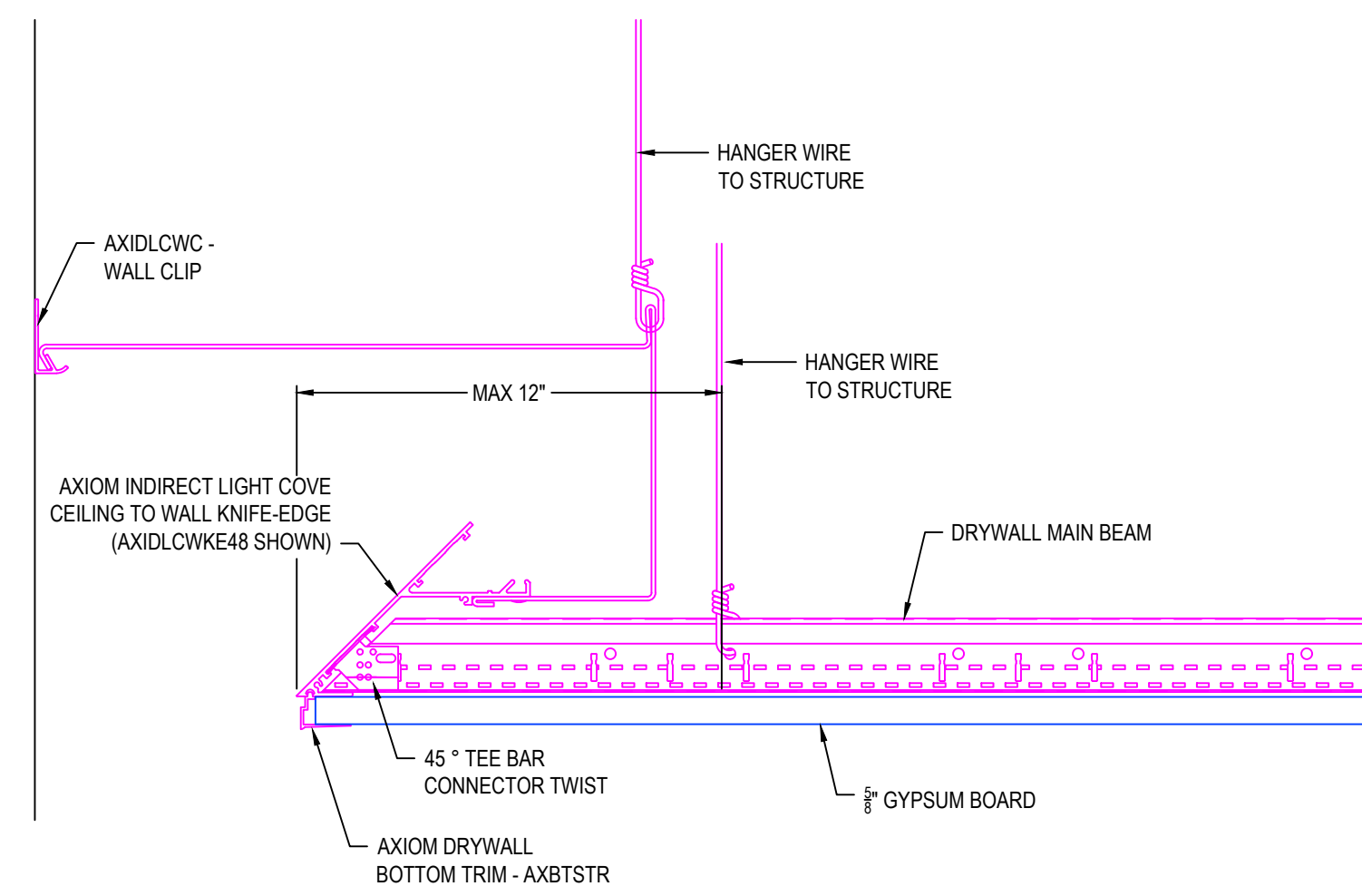
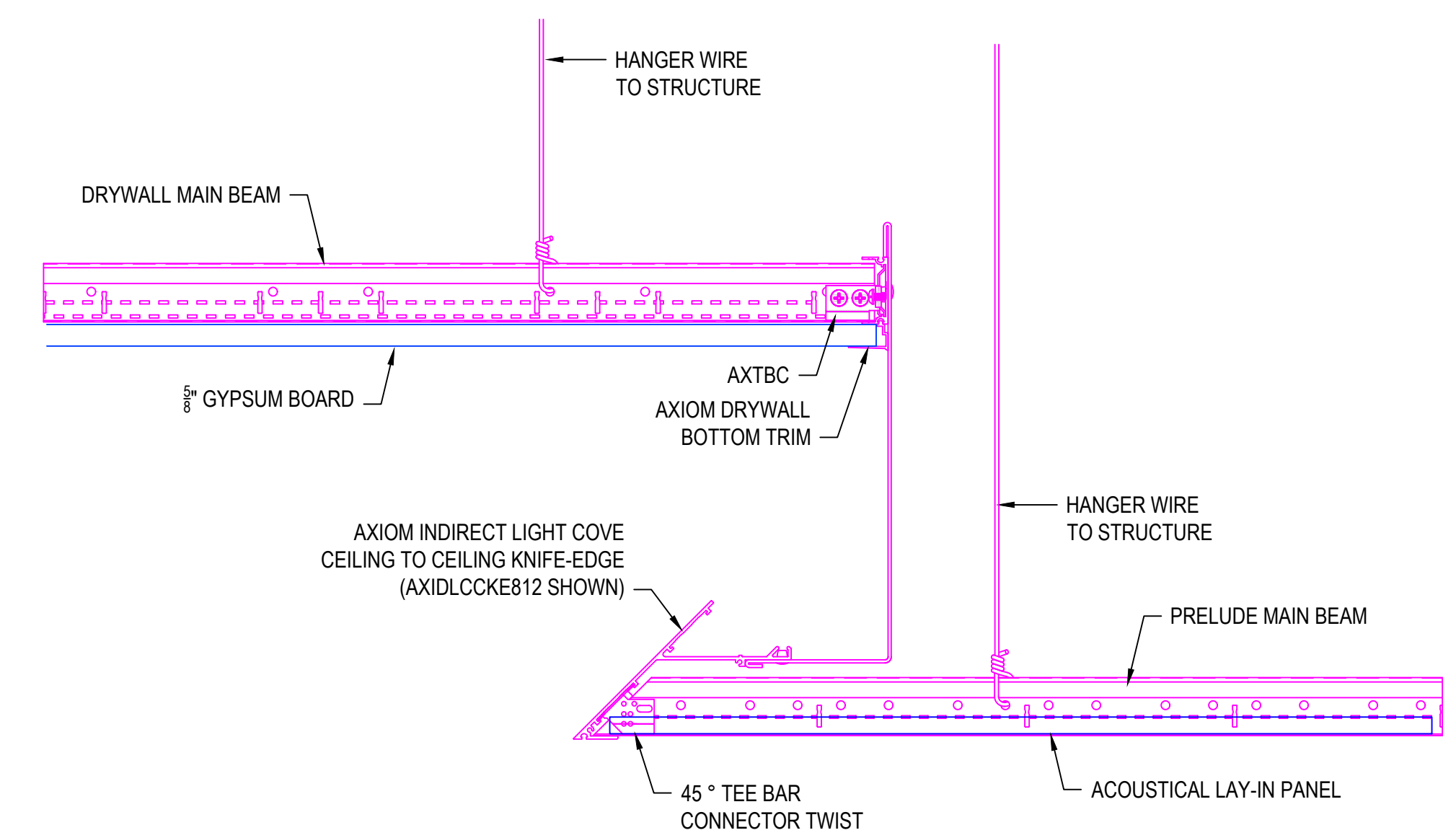
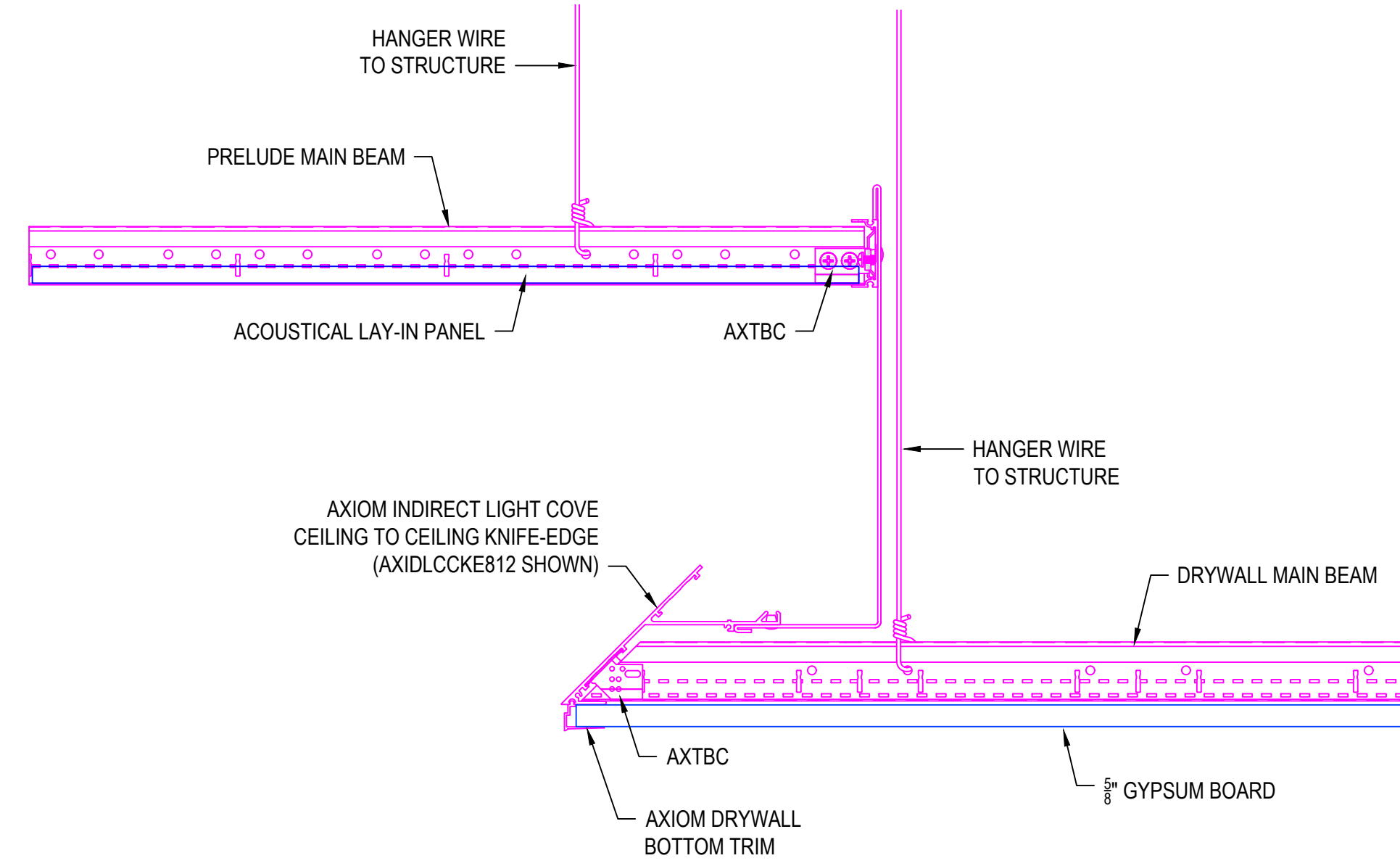
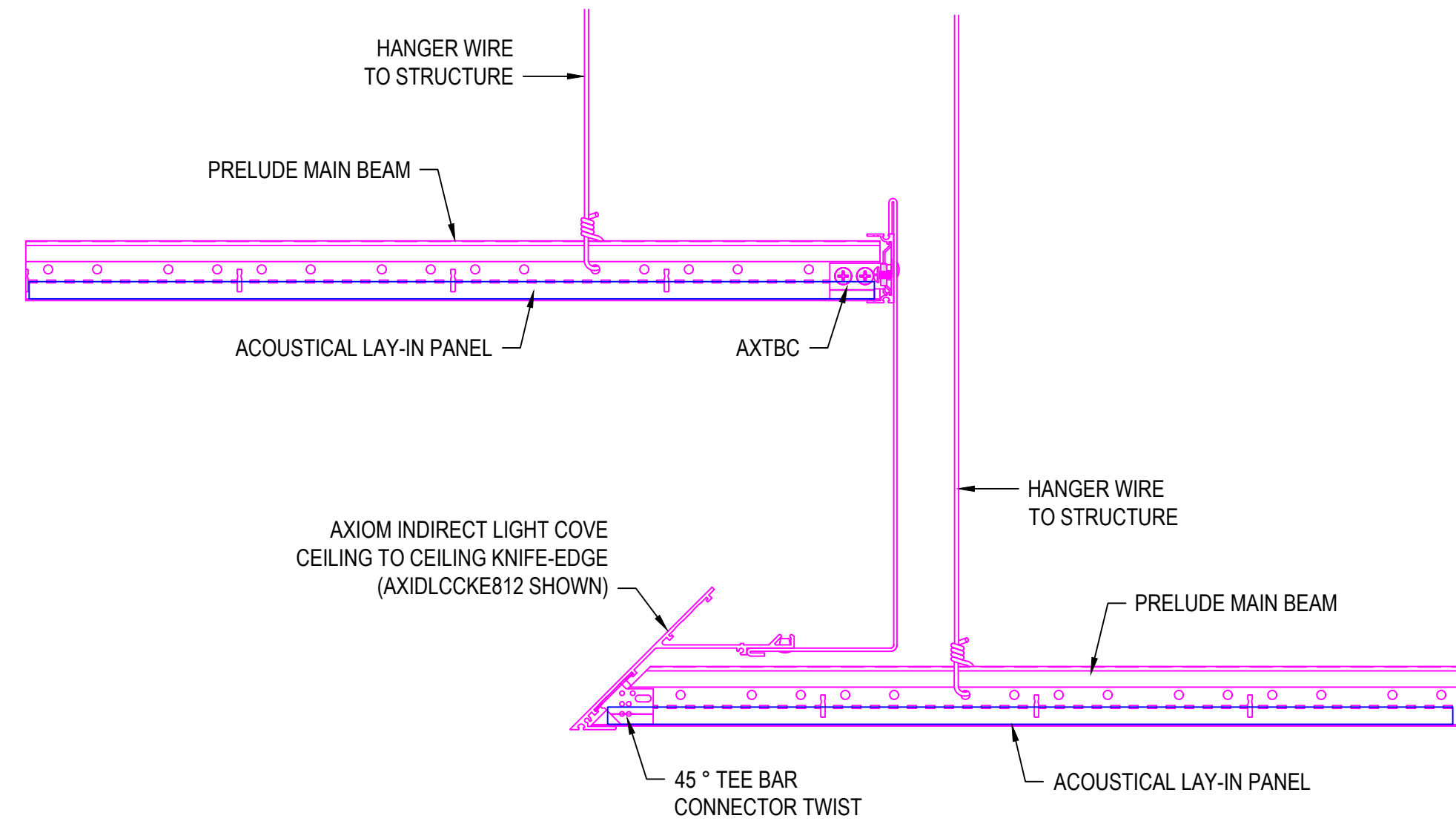

<p>These drawings show typical conditions in which the Armstrong product depicted is installed. They are not a substitute for an architect's or engineer's plan and do not reflect the unique requirements of local building codes, laws, ordinances, rules and regulations (Legal Requirements) that may be applicable for a particular installation.</p> <p>Armstrong does not warrant, and assumes no liability for the accuracy or completeness of the drawings for a particular installation or their fitness for a particular purpose. The user is advised to consult with a duly licensed architect or engineer in the particular locale of the installation to assure compliance with all Legal Requirements.</p> <p>Armstrong is not licensed to provide professional architecture or engineering design services.</p>		<p>PROJECT NAME: INDIRECT LIGHT COVE MASTER SHEET</p>	
DWG. NO. KNIFE-EDGE APPLICATIONS	REV: . .	DATE: 6/29/23	DATE: . .
DRAWN BY: MAP	SCALE: . .	CHK BY: . .	DESC: . .
<p>Techline ARMSTRONG CEILING SYSTEMS * ARMSTRONG WORLD INDUSTRIES, INC. * Lancaster, PA * Phone: 877-ARMSTRONG</p>		<p>Amstrong</p>	