

These drawings show typical conditions in which the Armstrong product depicted is installed. They are not intended to be an endorsement or approval of any other product or material, nor do they constitute a warranty of any kind. The user is advised to consult with a duly licensed architect or engineer in the particular locale of the installation for a particular application for a particular installation.

Armstrong Ceiling Solutions does not warrant, and assumes no liability for the accuracy or completeness of the drawings for a particular installation or their fitness for a particular purpose. The user is advised to consult with a duly licensed architect or engineer in the particular locale of the installation to ensure compliance with all applicable codes and regulations.

Armstrong is not licensed to provide professional architecture or engineering design services.

PROJECT NAME:	AXIOM DIRECT LIGHT COVE		
DWG. NO. SHEET 1	MASTER SHEET		
DATE: 11/21/23	SCALE:	REV:	DATE:
DRAWN BY: MAP	CHK BY:		

Techn ARMSTRONG CEILING & WALL SOLUTIONS • Lancaster, PA • Phone: 877-ARMSTRONG

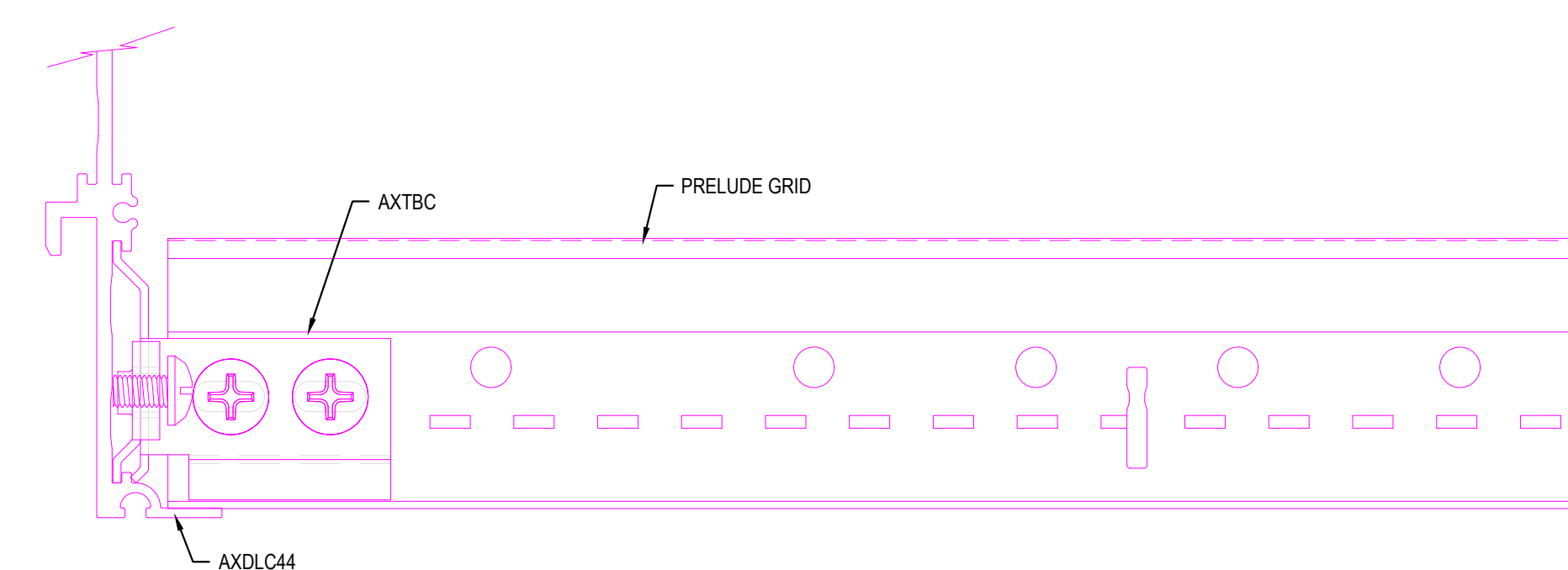
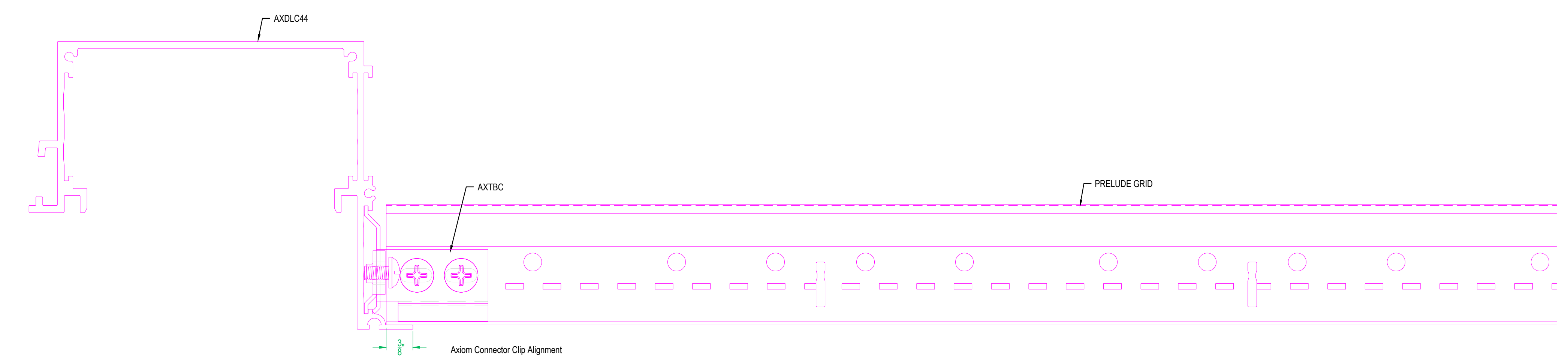
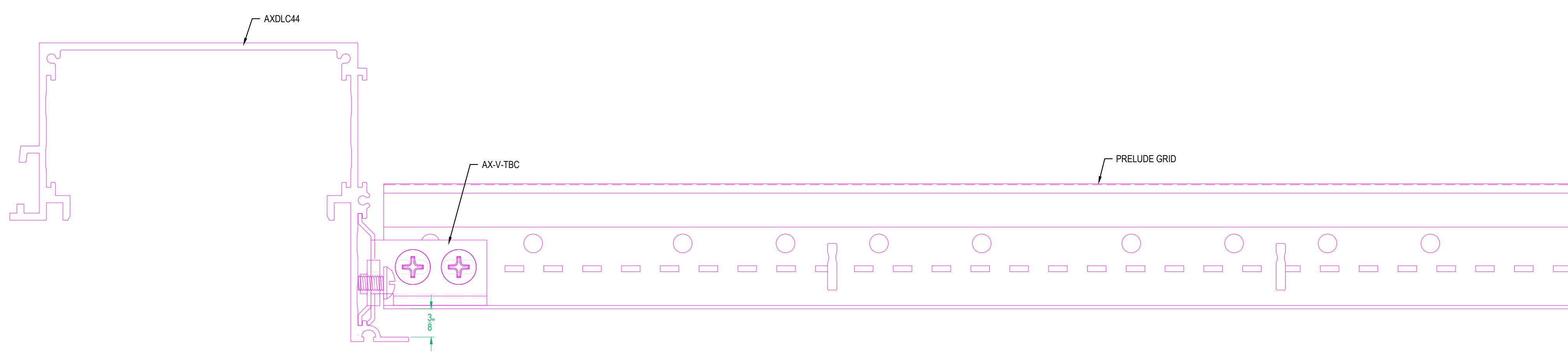
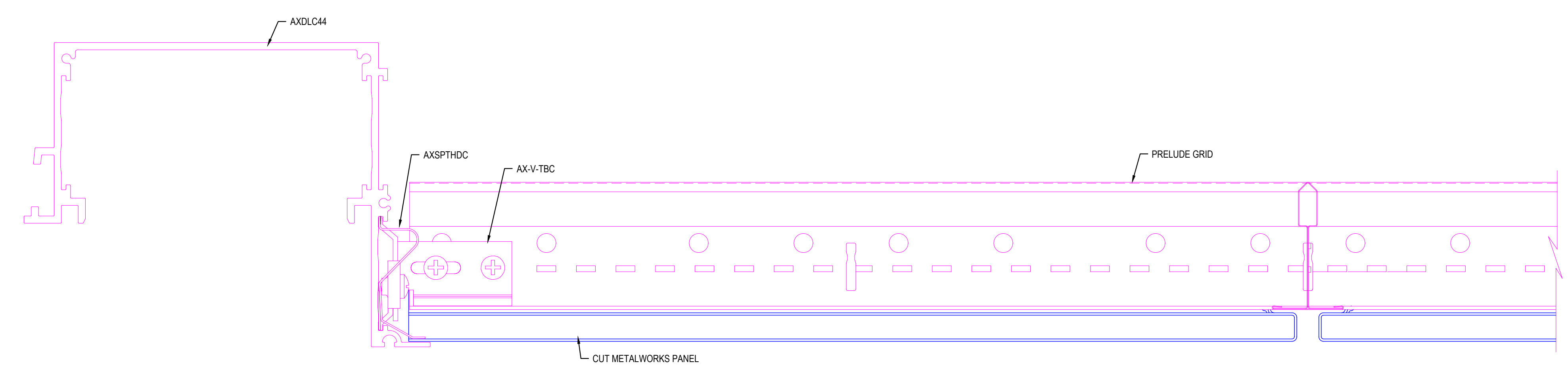
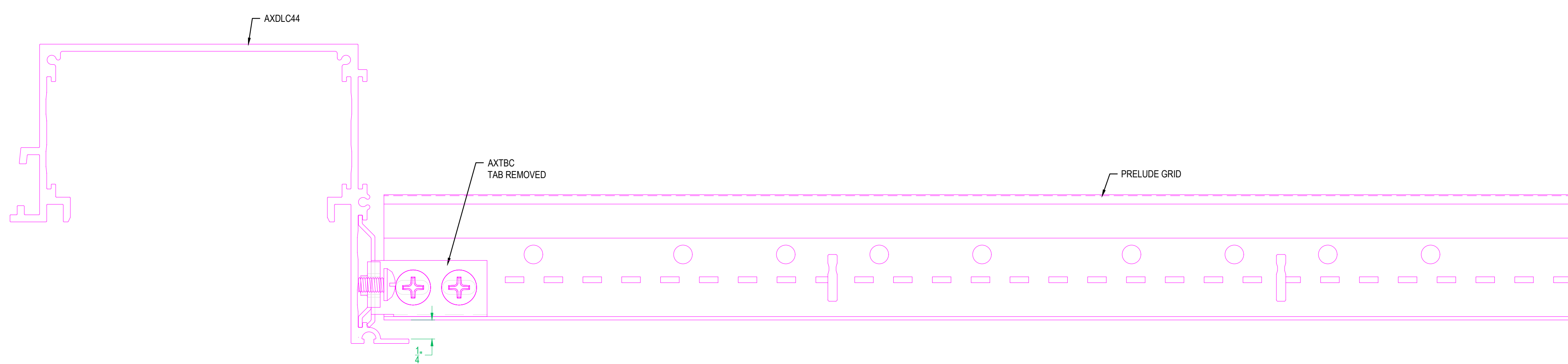
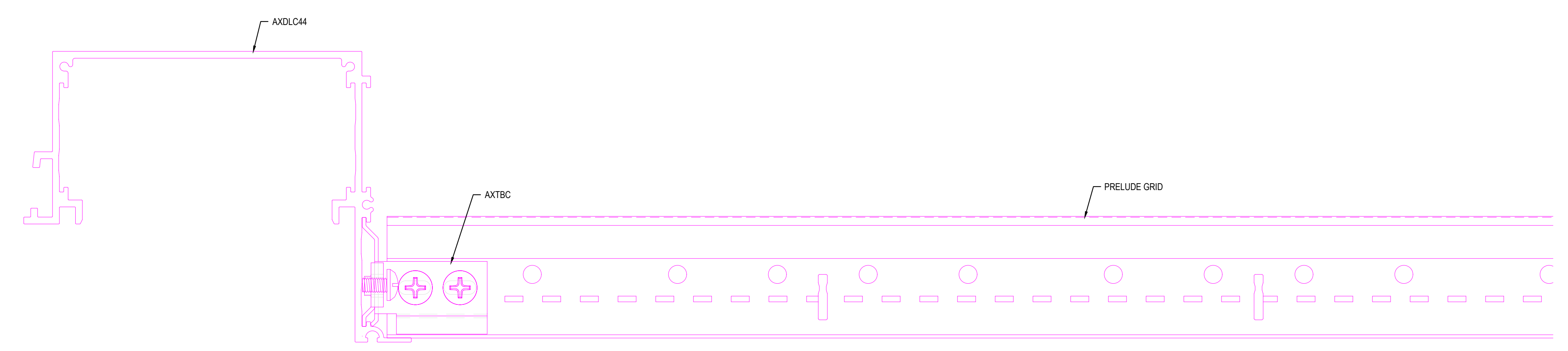
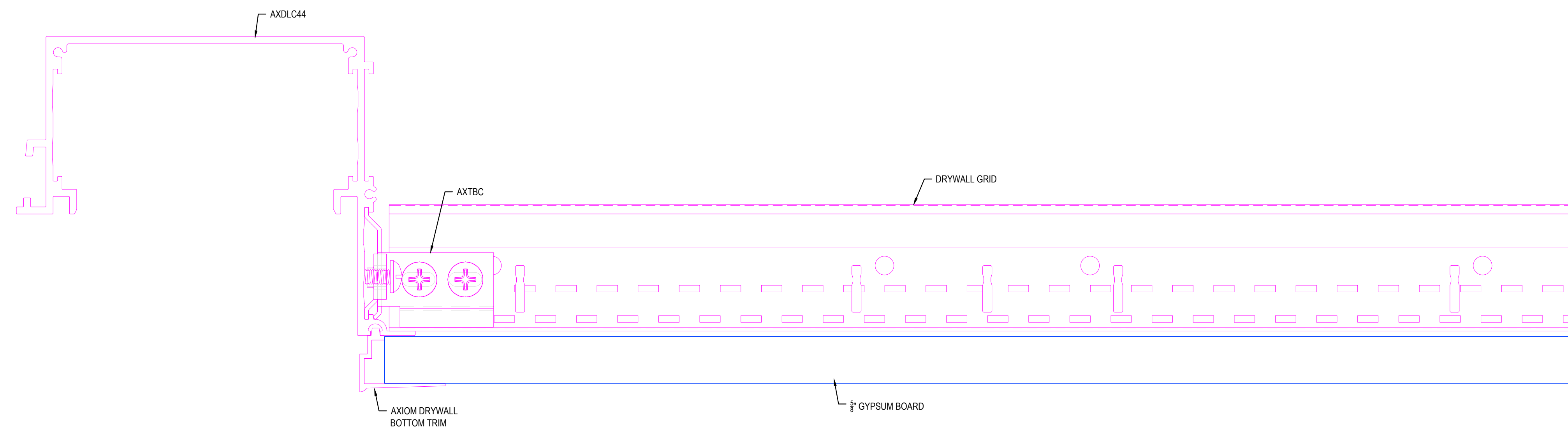
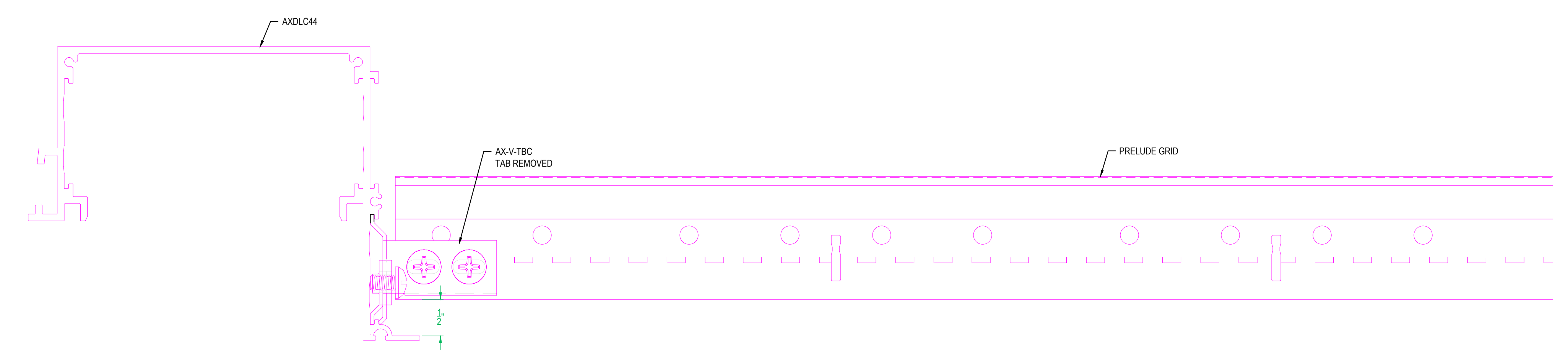
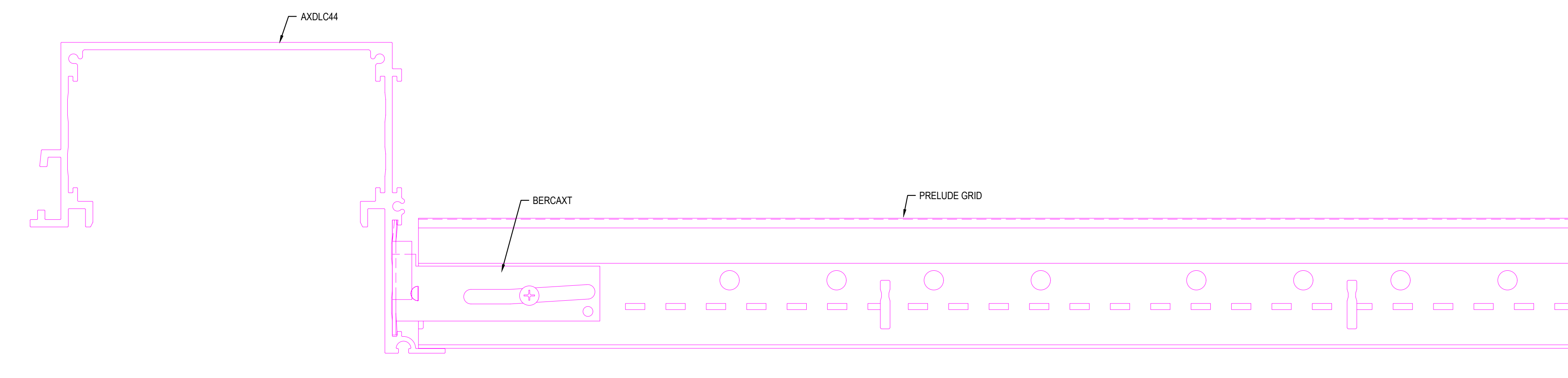

<p>These drawings show typical conditions in which the Armstrong product depicted is installed. They are not intended to be an endorsement or approval of any other product or material, nor do they constitute a warranty or representation of any kind. The user is advised to consult with a qualified architect or engineer in the particular locale of the installation to determine the appropriate code requirements and regulations that may apply to a particular installation.</p> <p>Armstrong Ceiling Solutions does not warrant, and assumes no liability for the accuracy or completeness of the drawings for a particular installation or their fitness for a particular purpose.</p> <p>The user is advised to consult with a qualified architect or engineer in the particular locale of the installation to determine the appropriate code requirements and regulations that may apply to a particular installation.</p> <p>Armstrong is not licensed to provide professional architecture or engineering design services.</p>			
PROJECT NAME: AXIOM DIRECT LIGHT COVE		REV: . . . DATE: . . .	
DWG. NO. SHEET 2		SCALE: . . .	
DATE: 6/26/23	DRAWN BY: MAP	CHK BY: . . .	DESC: . . .