

new METALWORKS™ Linear – Synchro™
Standard Wall Planks



**24/7
DEFEND™**
Solutions for Healthier,
Safer Spaces

CONTAIN CLEAN PROTECT

CAD/Revit® drawings at:
armstrongceilings.com/cadrevit

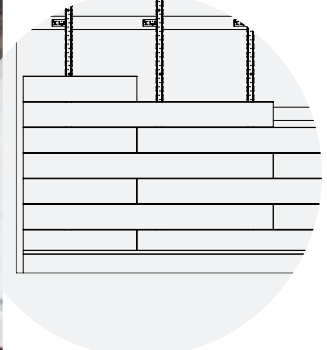

plus capabilities
to do more

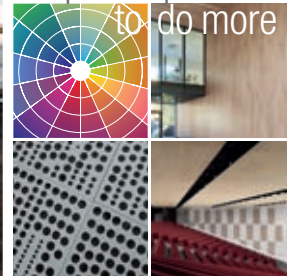

▲ MetalWorks™ Linear – Synchro™ 6" planks in Tech Black

armstrongceilings.com/capabilities
See more photos at:
armstrongceilings.com/photogallery

Durable, metal wall planks install in both horizontal and vertical orientations for design flexibility and contribute to healthy spaces for interiors

KEY SELECTION ATTRIBUTES

- new** • Install 4", 6", 9", 11", & 13" wide Linear – Synchro™ planks on interior wall applications horizontally or vertically with no additional clips or brackets needed
- Achieve high sound absorption for increased acoustical performance with microperforated planks – 0.70 NRC
- new** • Planks easily snap into upper hooks of new Main Beam Carrier 2 (item 7277MF)
- new** • CleanAssure™ family of products – includes disinfectable planks, suspension systems, and trim
- Linear - Synchro wall planks are available in 4 standard metal finishes and 17 Effects™ wood-look finish options
- Smooth monolithic visual with durable metal planks – perfect for high traffic areas

COLORS Due to printing limitations, shade may vary from actual product.

MetalWorks™ (Interior only)

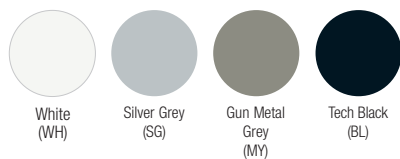

Effects™ Classic (Interior only)

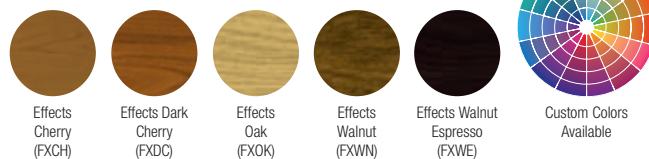

new **Effects™ Bold (Interior only)**

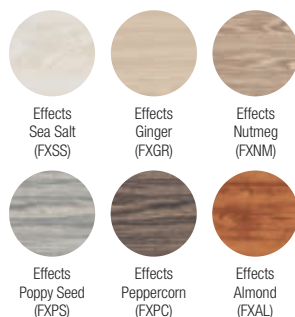

new **Effects™ Subtle (Interior only)**

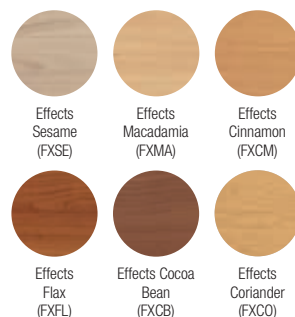

PERFORATION OPTIONS (1:2 scale shown)

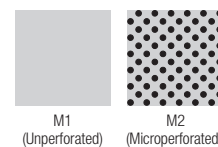

TechLine 877 276-7876
armstrongceilings.com/metalwalls

new METALWORKS™ Linear – Synchro™
Standard Wall Planks

LEED® WELL™ LBC
UP TO **25% RECYCLED CONTENT**

energy management
construction waste mgmt
regional materials
design for flexibility
EPD
recyclable/excise producer resp.
biobased materials
recycled content
sourcing of raw materials
material ingredient reporting
low emitting materials
lighting quality
acoustics

Calculate sustainability with GreenGenie™
armstrongceilings.com/greengenie

LOCATION DEPENDENT
WHITE WITH ONLY INFILL PANEL

VISUAL SELECTION

Item No. ♦	Description	Dimensions Nominal W x L x D (Inches) Custom Sizes Available	Module Width (Inches)
METALWORKS™ Linear – Synchro™ Planks 8223W04	4" Plank	4 x 96 x 1"	4.50"
8223W06	6" Plank	6 x 96 x 1"	6.75"
8223W09	9" Plank	9 x 96 x 1"	9.00"
8223W11	11" Plank	11 x 96 x 1"	11.25"
8223W13	13" Plank	13 x 96 x 1"	13.50"

PERFORMANCE Dots represent high level of performance.

Fire Performance	Light Reflect (M1 White only)	CleanAssure™ Disinfectable Planks							DURABILITY			Acoustics (M2 Perf only)
		Fog	Spray	Wipe	Wash	Scrub	Impact	Scratch	Soil			
Class A	0.83	•	•	•	•	•	•	•	•	•	•	0.70
Class A	0.83	•	•	•	•	•	•	•	•	•	•	0.70
Class A	0.83	•	•	•	•	•	•	•	•	•	•	0.70
Class A	0.83	•	•	•	•	•	•	•	•	•	•	0.70
Class A	0.83	•	•	•	•	•	•	•	•	•	•	0.70

♦ When specifying or ordering, include the appropriate 2-letter perforation suffix and 2- or 4-letter color suffix (e.g., 8223W04 **M 1 F X C H**, 8223W11 **M 2 S G**).

PHYSICAL DATA

Material
Electrogalvanized Steel – thickness 0.028"

Surface Finish
Available in White, Silver Grey, Gun Metal Grey, Tech Black, and Effects™ Wood Looks powder-coated, post-production finishes. Custom colors are also available, contact ASQuote@armstrongceilings.com for custom requests.

Plank Reveal
MetalWorks™ Linear – Synchro™ planks have a butt joint installation with no reveal between planks for a monolithic visual.

Fire Performance
Class A: ASTM E84 and CAN/ULC S102. Flame Spread Index 25 or less. Smoke Developed Index 50 or less.

ASTM E1264 Classification
Fire Class – Class A
Unperforated – Type XX, Form 2, Pattern G
Perforated – Type XX, Form 2, Pattern C

Seismic Restraint
MetalWorks Linear – Synchro planks have been engineered, tested, and approved for application in all seismic areas when installed per Armstrong Ceilings installation instructions.
When installed properly, both planks and suspension have been tested to stay in place through vibrations and other seismic events.

Cleaning and Disinfecting
Cleaning and CDC approved disinfecting options available on armstrongceilings.com/cleaning

Warranty
Details at armstrongceilings.com/warranty

Weight; Square Feet/Cartron
8223W04 – 4.45 lbs/SF; 12 pcs/ctn; 36 SF/ctn
8223W06 – 6.05 lbs/SF; 8 pcs/ctn; 36 SF/ctn
8223W09 – 7.95 lbs/SF; 6 pcs/ctn; 36 SF/ctn
8223W11 – 9.6 lbs/SF; 4 pcs/ctn; 30 SF/ctn
8223W13 – 10.85 lbs/SF; 4 pcs/ctn; 33 SF/ctn





METALWORKS™ Linear – Synchro™

Standard Wall Planks

ACCESSORIES

Item No. ◆	Description	Pieces/ Carton	Finish Selection - Interior
8161	Pressure Spring	50	N/A
8233W04M1_ _ _ _	4" End Cap	10	WH, SG, MY, BL, and all Effects Wood Looks
8233W06M1_ _ _ _	6" End Cap	10	WH, SG, MY, BL, and all Effects Wood Looks
8233W09M1_ _ _ _	9" End Cap	10	WH, SG, MY, BL, and all Effects Wood Looks
8233W11M1_ _ _ _	11" End Cap	10	WH, SG, MY, BL, and all Effects Wood Looks
8233W13M1_ _ _ _	13" End Cap	10	WH, SG, MY, BL, and all Effects Wood Looks
8243W02	2" Splice Plate	10	N/A
8243W04	4" Splice Plate	10	N/A
8243W06	6" Splice Plate	10	N/A
7113	Spreader Hold Down	40	N/A

TRIM Required clips must be ordered separately

Item No. ◆	Description	Dimensions Nominal L x W x H (Inches)	Pieces/ Carton	Colors
AX6VSTR_ _	Axiom® Vector® Trim – 6" Straight	3/4 x 120 x 6"	–	WH, SG, MY, BL
AX4STR_ _ _ _	Axiom® Classic Trim – 4" Straight	3/4 x 120 x 4"	–	WH, SG, MY, BL
5344_ _ _ _	4" Effects Wood Looks Trim	Nominal 120" length	6	All Effects Wood Looks
5346_ _ _ _	6" Effects Wood Looks Trim	Nominal 120" length	6	All Effects Wood Looks
7239	Adjustable Trim Clip	2-1/2 x 2-1/2 x 1-1/4"	25	N/A

SUSPENSION SYSTEM COMPONENTS

Item No. ◆	Description	Dimensions Nominal L x W x H (Inches)	Pieces/ Carton
7237	Cut Plank Support Bracket	2-1/2 x 2-1/2 x 1-1/4"	25
7277MF	Main Beam Carrier 2 (MBC2) – Mill Finish	144 x 1-3/4 x 2-3/4"	10
5574_ _ _ _ _	Carrier Molding	120 x 1 x 1"	10
7800_	Hemmed Angle Molding (Seismic installations only)	144 x 7/8 x 7/8"	30
XL8926	2" Drywall Cross Tee	24 x 1-1/2 x 1-1/2"	36

◆ When specifying or ordering, include the appropriate letter color suffix (e.g., 8233W02M1 **B** L, 8233W02M1 **E** X **C** H).



INSTALLATION DETAILS – WALLS

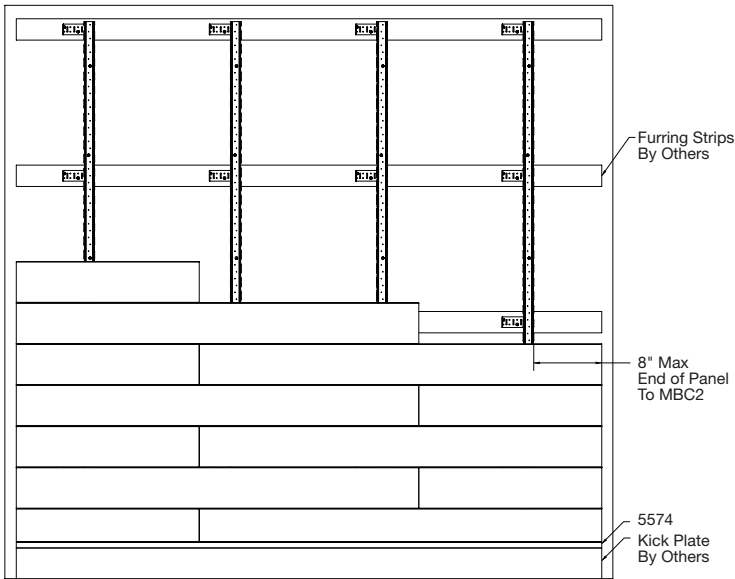

Main Beam Carrier 2 (MBC2) installs on the wall perpendicular to desired plank length direction

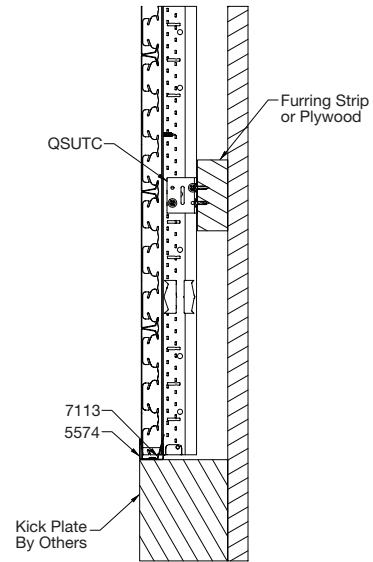

Install QSUTC to furring strips or 5/8" plywood, securing them with appropriate fasteners for the substrate to the structure

