

WOODWORKS® Concealed  
Concealed Suspension

*Custom looks  
with Standard  
Products*



24/7  
**DEFEND™**  
Solutions for Healthier,  
Safer Spaces

CONTAIN CLEAN PROTECT

CAD/Revit® drawings at:  
[armstrongceilings.com/cadrevit](http://armstrongceilings.com/cadrevit)

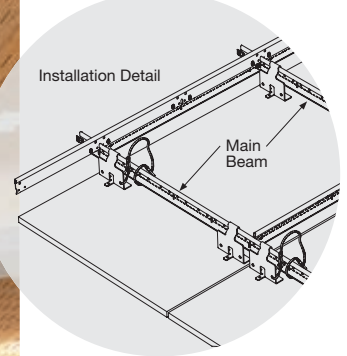
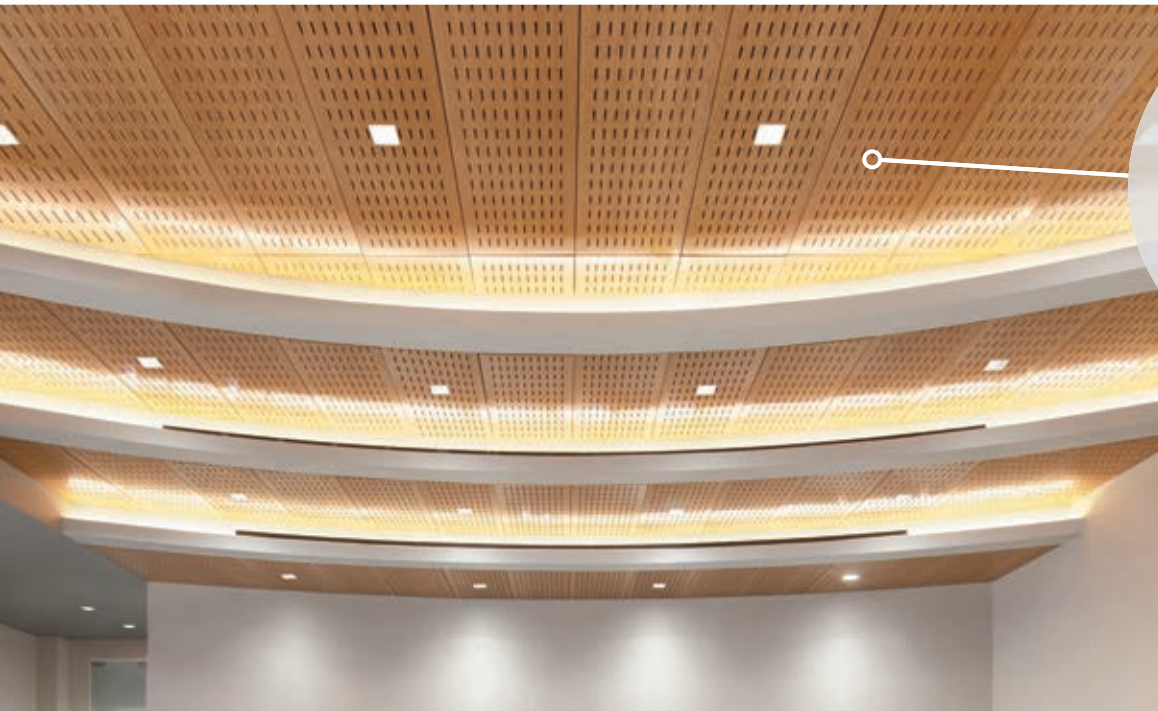

plus capabilities  
to do more

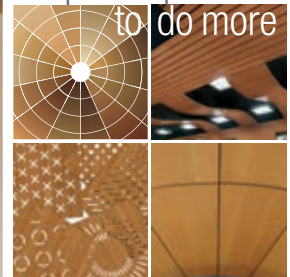

[armstrongceilings.com/capabilities](http://armstrongceilings.com/capabilities)  
See more photos at:  
[armstrongceilings.com/photogallery](http://armstrongceilings.com/photogallery)

▲ WoodWorks® Concealed 24" x 72" panels with W5 perforation in Bamboo Patina with Prelude® 15/16" suspension system

This easy-to-install ceiling with a concealed suspension offers a continuous, monolithic visual.

KEY SELECTION ATTRIBUTES

- Mix and match standard panel sizes on the same project
- Narrow 1/4" reveal visual and 6" aluminum trim available in coordinating wood finishes, or black
- CleanAssure™ family of products – includes disinfectable panels, suspension systems, and trim
- Select products included in the FAST134 program – ready to ship in 4 weeks or less
- Coordinating WoodWorks® walls
- Hook-on panels (for standard 15/16" suspension system) provide safe and secure downward accessibility
- Shorter lead times and lower cost than custom millwork
- Factory-edge banded for superior quality
- Complete standard system from one manufacturer (suspension system/ panels/trim)
- Acoustical fleece option available for increased sound absorption
- USDA Biobased content: 100%

VENEERS Due to printing limitations, shade may vary from actual product.

Natural Variations™  
(Real Wood Veneers)



Constants™  
(Real Wood Veneers)

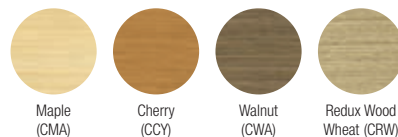

Bamboo\*

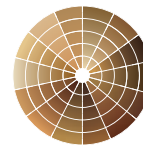
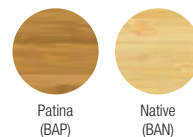

Custom Veneers and  
Finishes Available  
(extended lead times)

\* Veneer is rapidly renewable.  
Bamboo is a grass that only requires 3-7 years for maturity and does not have to be replanted after each harvest.

PERFORATION OPTIONS (Actual 1:6 scale shown)

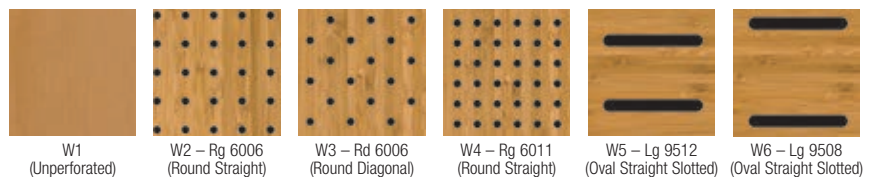

*Custom  
Perforations  
Available*

TechLine 877 276-7876  
[armstrongceilings.com/woodworksconcealed](http://armstrongceilings.com/woodworksconcealed)

NOTE: Slotted perforations run parallel to the length of the panel and borders vary with panel size.



# WOODWORKS® Concealed

## Concealed Suspension



LEED WELL LBC

UP TO 75% RECYCLED CONTENT

energy management  
construction waste mgmt  
regional materials  
design for flexibility  
EPD

recyclable/extended producer resp.  
biobased materials  
FSC® (for wood)  
recycled content  
sourcing of raw materials  
material ingredient reporting  
low emitting materials  
lighting quality  
acoustics

LOCATION DEPENDENT

WITH INFILL PANEL

Calculate sustainability with GreenGenie™  
armstrongceilings.com/greengenie

### VISUAL SELECTION

Edge Profile	Item No. ♦	Dimensions Nominal W x L x H (Inches) Custom Sizes Available	Perforations
FSC® certified WOODWORKS® Concealed 1/4" Reveal	5983	24 x 48 x 3/4"	W1, W2, W3, W4, W5, W6
	5984	24 x 72 x 3/4"	W1, W2, W3, W4, W5, W6
	5985	24 x 96 x 3/4"	W1, W2, W3, W4, W5, W6

### PERFORMANCE

Fire Rating	CleanAssure™ DURABILITY Disinfectable Panels			
	Fog	Spray	Wipe	Soil
Class A	•	•	•	•
Class A	•	•	•	•
Class A	•	•	•	•

### ACOUSTICAL INFORMATION

Performance determined by perforation size.  
Dots represent high level of performance.

Perforation	NRC**
W1 Unperforated	N/A
W2 Round Straight	0.40
W3 Round Diagonal	0.40
W4 Round Straight	0.65
W5 Oval Straight Slotted	0.55
W6 Oval Straight Slotted	0.40



FAST134 program items ready to ship from manufacturer in 4 weeks or less.  
Up-to-date lead times and product options (sizes and colors) at [armstrongceilings.com/fast134](http://armstrongceilings.com/fast134).

♦ When specifying or ordering, include the appropriate 2-digit perforation and 3-letter color suffixes.  
For veneers, sizes, and perforation patterns available as special order, call TechLine at 1 877 276-7876.

\*\* Maximum NRC achieved with acoustical infill (item 8200T10 or 5479, unless noted otherwise).

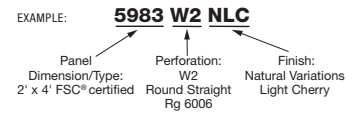

# WOODWORKS® Concealed

## Concealed Suspension

USDA  
CERTIFIED  
BIOBASED  
PRODUCT  
PRODUCT 100%



LEED® WELL™ LBC  
UP TO 75% RECYCLED CONTENT

energy management  
construction waste mgmt  
regional materials  
design for flexibility  
EPD  
recyclable/extended producer resp.  
biobased materials  
FSC® (for wood)  
recycled content  
sourcing of raw materials  
material ingredient reporting  
low emitting materials  
lighting quality  
acoustics

LOCATION DEPENDENT

Calculate sustainability with GreenGenie™  
armstrongceilings.com/greengenie

### ACCESSORIES

Item No. ♦	Description	Dimensions Nominal (Inches)	Color	Pieces/Carton
8200T10	Fiberglass Infill Panel	24 x 24 x 1"	Black	12
5479	BioAcoustic™ Infill Panel	24 x 24 x 5/8"	Beige	12
5823	BioAcoustic Infill Panel	24 x 24 x 5/8"	Black (Matte)	12
7239	Adjustable Trim Clip	N/A	N/A	50

♦ When specifying or ordering, include the 3-letter color suffix that coordinates with your WoodWorks ceiling (e.g., 6408 **N M P**)  
\* Trim cartons include FXTBC Clips and FX4SPLICE Splice Plates.  
NOTE: Adjustable Trim Clip used with standard Axiom® or MetalWorks™ Trim systems.

### SUSPENSION SYSTEMS

When ordering suspension system materials, please note that this product requires Prelude® Heavy-duty (HD) main beams and 2' cross tees that are full height (1-11/16"). Both suspension system components should be specified in Tech Black (BL). 15/16" Prelude® BL HD (Tech Black)

Item No.	Description	Dimensions (Inches)	Pieces/Carton
5986	T-Bar Hook†	Nominal 4 x 2 x 3"	50
7123	Wood Screws	5/8"	300/Pkg
6091	Safety Cable	24" x 3/32"	50
SH12	Support Hanger	144" x 2"	12

† For 24" x 48" panel, install 4 hooks; for 24" x 72" panel, install 6 hooks; for 24" x 96" panel, install 8 hooks.  
NOTE: Three screws per hook. Refer to installation instructions at armstrongceilings.com/installation for a better understanding of suspension systems requirements.

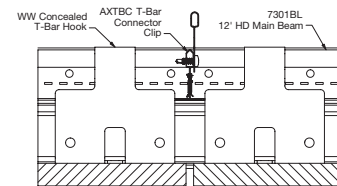

Installation Detail – WoodWorks Concealed Ceiling System

### TRIM FOR WOODWORKS® PANELS

Item No. ♦	Description	Dimensions Nominal W x L x H (Inches)	Colors	Pieces/Carton
		Custom Sizes Available		
6603W1__**	Concealed Trim (aluminum) for WoodWorks panels	6" x 120"	See below	6
6408__*	3/4" Edge Banding	3/4" x 300"	See below	1

♦ When specifying or ordering, include the 3-letter color suffix that coordinates with your WoodWorks ceiling (e.g., 6603W1**N M P**)  
\* Images™ edge banding coordinates with Natural Variations™ Light Cherry, Dark Cherry, and Maple. Use the Natural Variations colors when ordering.  
\*\* FXTBC, FXPSPLICE, FX4SPLICE, included.

### AXIOM® TRIM

Trim cartons include AXTBC Clips and AXSPLICE Plates.

Item No. ♦♦	Description	Dimensions Nominal W x L x H (Inches)	Pieces/Carton
		Custom Sizes Available	
7239***	Adjustable Trim Clip Allows Axiom trim to be positioned up to 3-3/4" below the grid face to accommodate deeper panel offsets (best aesthetic with Axiom ≥ 6" tall)	—	50

**FAST**  
4 WEEKS  
or Less

FAST134 program items ready to ship from manufacturer in 4 weeks or less.  
Up-to-date lead times and product options (sizes and colors) at armstrongceilings.com/fast134.

♦♦ When specifying or ordering, include the appropriate 2-letter color suffix.  
\*\*\* Specify aluminum substrate trim to be used with WoodWorks® panels or planks that drop greater than 3/8" below the grid flange, such as Channeled, Linear, or Grille products.

### INSTALLATION OF TRIM (ALUMINUM SUBSTRATE) FOR WOODWORKS® PANELS

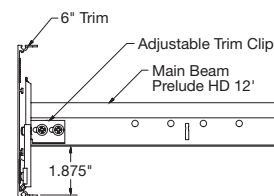

Adjustable Trim Clip (7239) in standard position



WOODWORKS® – Standard

# WOODWORKS® Concealed Concealed Suspension

USDA  
CERTIFIED  
BIOBASED  
PRODUCT  
PRODUCT 100%



LEED® WELL™ | LBC  
UP TO 75% RECYCLED CONTENT

energy management  
construction waste mgmt  
regional materials  
design for flexibility  
EPD  
recyclable/extended producer resp.  
biobased materials  
FSC® (for wood)  
recycled content  
sourcing of raw materials  
material ingredient reporting  
low emitting materials  
lighting quality  
acoustics

LOCATION DEPENDENT

Calculate sustainability with GreenGenie™  
armstrongceilings.com/greengenie

WITH INFILL PANEL

## VENEER TRIM FINISHES FOR WOODWORKS® PANELS

Due to printing limitations, shade may vary from actual product.

### Natural Variations™ (Real Wood Veneers)

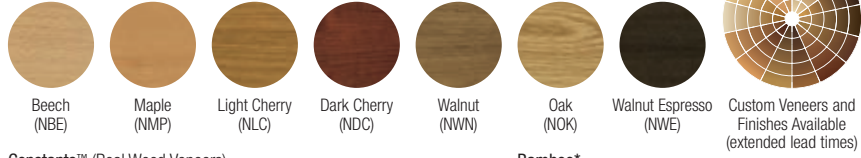

### Constants™ (Real Wood Veneers)



### Bamboo\*



\* Veneer is rapidly renewable. Bamboo is a grass that only requires 3-7 years for maturity and does not have to be replanted after each harvest.

## INFILL PANELS

Item Number	Description	Dimensions (Inches)	NRC	CAC	Colors	Pieces/Carton
5479	BioAcoustic™ Infill Panel	24 x 24 x 5/8"	0.75	N/A	Beige Matte	12
5823	BioAcoustic Infill Panel	24 x 24 x 5/8"	0.75	N/A	Black Matte	12
8200T10	Fiberglass Infill Panel	24 x 24 x 1"	0.80	N/A	Black Gloss	12

## INFILL PANEL OPTIONS



1. BioAcoustic™ Infill Panel 5823 – Black
2. BioAcoustic™ Infill Panel 5479 – Beige
3. 1" Fiberglass Infill Bag 8200T10

## PHYSICAL DATA

**Material**  
FSC® certified fire-retardant particle board with face-cut veneers (RA-COC-003601). For more information about FSC® certified products, or to view our FSC® certification letter, visit [armstrongceilings.com/woodworksfsc](http://armstrongceilings.com/woodworksfsc)

6603 - Face-cut veneer or black paint on aluminum laminate substrate

**Surface Finish**  
Clear or tinted semi-gloss coating

**Fire Performance**  
Class C: ASTM E84 surface burning characteristics. Flame Spread Index 25 or less. Smoke Developed Index 50 or less.  
Class A: CAN/ULC S102 surface burning characteristics. Flame Spread Rating 25 or less. Smoke Developed Classification 50 or less.

**ASTM E1264 Classification**  
Type XX - Fire Class A

**Primary (Embodied) Energy**  
See all LCA information on our EPDs.

**Application Considerations**  
Variation among panels may occur due to the natural characteristics of the wood and grain.

Use of large wood panels may result in deflection up to 1/8" and cause alignment inconsistency due to size and ambient conditions.

It is very important that WoodWorks® panels are climatized prior to installation. Relative humidity between 25% and 55%, and temperatures between 50F and 86F, must be maintained throughout the life of the product.

**Design Considerations**  
For additional configuration ideas, refer to the WoodWorks Concealed Technical Guide, BPCS-4274, or visit [armstrongceilings.com/woodworks](http://armstrongceilings.com/woodworks)

Do not mix different panel sizes with slotted perforations. Perforation borders will not align. The use of Armstrong® Prelude® 15/16" suspension system is strongly recommended.

Cloud installations less than 6' wide are not recommended. Not recommended for SingleSpan™ corridor applications.

**Specification Consideration**  
Attention: For FSC® certified wood products to maintain their CoC certification, products must be sold to a CoC certified distributor, or directly to the installing contractor. Failure to do so breaks the CoC.

**Seismic Restraint**  
WoodWorks Concealed panels have been engineered, tested, and approved for application in all seismic areas when installed per Armstrong Ceilings installation instructions.

**Cleaning and Disinfecting**  
Cleaning and CDC approved disinfecting options available on [armstrongceilings.com/cleaning](http://armstrongceilings.com/cleaning)

**FAST134 Program Considerations**  
Size of Job Matters: Big jobs, over 2500 SF or 50 pieces for shapes/vertical elements will have longer lead times.  
Location Matters: Transit time not included. We are ready to ship in 1 week on FAST1 items. However, transit to the states west of Wyoming may add time.  
Distributor Truck Schedule Matters: We rely on distribution to help move products around the country. When speed matters, work with your local distributor to ensure FAST134 service.  
Stock vs Made-to-Order Matters: FAST3 & FAST4 items are made-to-order and will ship direct to distributor. FAST1 (stocked items) will go through distribution and depend on distributor truck schedules.

**Warranty**  
Details at [armstrongceilings.com/warranty](http://armstrongceilings.com/warranty)

**Weight/Square Feet**  
5983, 5984, 5985 - 2.75 lbs/SF; bulk packaged per order. Suspension system, hardware, and accessories ordered separately.

