

METALWORKS™ Concealed  
smooth texture

*Custom Looks  
with Standard  
Products*



24/7  
**DEFEND™**  
Solutions for Healthier,  
Safer Spaces

CONTAIN CLEAN PROTECT

CAD/Revit® drawings at:  
[armstrongceilings.com/cadrevit](http://armstrongceilings.com/cadrevit)

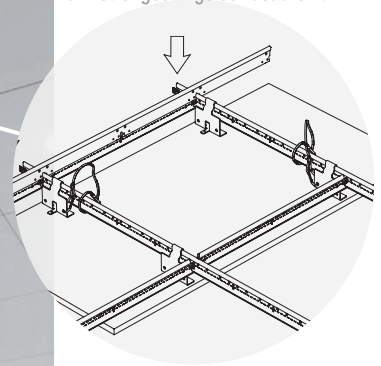

▲ MetalWorks™ Concealed 48" x 96" panels in Silver Grey

See more photos at:  
[armstrongceilings.com/photogallery](http://armstrongceilings.com/photogallery)  
SEARCH: metalworks concealed

Large-size panels with concealed suspension are 100% accessible.

KEY SELECTION ATTRIBUTES

- Narrow 1/4" reveal offers clean, monolithic look
  - Hook-on panels provide safe and secure downward accessibility
  - Create continuous look or use with clouds and perimeter trim
- new**
- CleanAssure™ family of products – includes disinfectable panels, suspension systems, and trim
  - Lightweight panels install with standard 15/16" suspension system
  - Complete standard system from one manufacturer

**COLORS** Due to printing limitations, shade may vary from actual product.

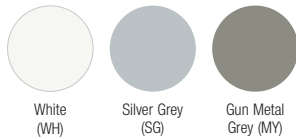

**PERFORATION OPTIONS** (1:2 scale shown)

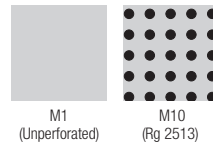

# METALWORKS™ Concealed

smooth texture

**LEED® WELL™ LBC**

UP TO **85% RECYCLED CONTENT**

energy management  
construction waste mgmt  
regional materials  
design for flexibility  
EPD  
recyclable/excise producer resp.  
biobased materials  
recycled content  
sourcing of raw materials  
material ingredient reporting  
low emitting materials  
lighting quality  
acoustics

Calculate sustainability with GreenGenie™  
armstrongceilings.com/greengenie

LOCATION DEPENDENT

WITH INFILL PANEL

## VISUAL SELECTION



Item No. ♦	Dimensions (Inches) W x L x H	Perforations
<b>METALWORKS™ Concealed</b> 1/4" Reveal 		
<b>6664</b> _____	24 x 96 x 5/8"	M1; M10
<b>6665</b> _____	24 x 120 x 5/8"	M1; M10
<b>6666</b> _____	48 x 48 x 5/8"	M1; M10
<b>6667</b> _____	48 x 96 x 5/8"	M1; M10
<b>6668</b> _____	48 x 120 x 5/8"	M1; M10

## PERFORMANCE

Dots represent high level of performance.

Fire Performance 	(White only) Light Reflect	CleanAssure™ Disinfectable Panels							DURABILITY
		Fog	Spray	Wipe	Wash	Scrub	Impact	Soil	
Class A	0.73 (M1)	•	•	•	•	•	•	•	•
Class A	0.73 (M1)	•	•	•	•	•	•	•	•
Class A	0.73 (M1)	•	•	•	•	•	•	•	•
Class A	0.73 (M1)	•	•	•	•	•	•	•	•
Class A	0.73 (M1)	•	•	•	•	•	•	•	•

## ACOUSTICAL INFORMATION

Perforation	NRC
<b>M1</b> Unperforated 	N/A
<b>M10</b> Rg 2513 	0.80 • 0.90† •

Maximum NRC achieved with acoustical infill options.  
† With BioAcoustic™ infill item 5479. NRC of 0.90 with fiberglass infill 8200T10, NRC 0.80 as sold.

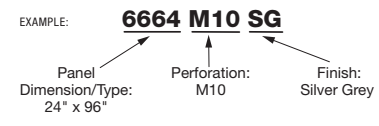

♦ When specifying or ordering, include the appropriate perforation and color suffix with the item number (e.g., 6664 M 1 M Y).

## ACCESSORIES

Item No. ♦	Description	Dimensions (Inches)	Color	Pieces/Carton
<b>6656M1</b> _ _	MetalWorks™ Concealed Trim	6" x 120"	WH, SG, MY	6
<b>7842A</b> _ _	Slip-on Molding	1/2 x 120 x 5/8"	WH, SG, MY	40
<b>FXTBC</b>	T-bar Connector Clip	-	-	10
<b>FX4SPlice</b>	Splice Plate with Set Screws	-	-	10
<b>8200T10</b>	Fiberglass Infill Panel	24 x 24 x 1"	Black (Gloss)	12
<b>5823</b>	BioAcoustic™ Infill Panel	24 x 24 x 5/8"	Black	12
<b>5479</b>	BioAcoustic™ Infill Panel	24 x 24 x 5/8"	Beige	12
<b>7239</b>	Adjustable Trim Clip	-	N/A	50

NOTE: Adjustable Trim Clip used with standard Axiom® or MetalWorks Trim systems.

## SUSPENSION SYSTEM

15/16" Heavy-duty Prelude® XL® Suspension System

Item No.	Description	Dimensions	Quantity
<b>5986</b>	T-Bar Hook†	Nominal 4 x 2 x 3"	50
<b>90190A242</b>	#10 Pan Head Sheet Metal Screw	1/2"	100
<b>6091</b>	Safety Cable	24" x 3/32"	50
<b>SH12</b>	Support Hanger	144" x 2"	12

† For 24" x 96", 48" x 48", and 48" x 96" panels, install 4 hooks per panel; for 24" x 120" and 48" x 120" panels install 6 hooks per panel.  
NOTE: Refer to installation instructions at armstrongceilings.com/installation for a better understanding of suspension requirements.

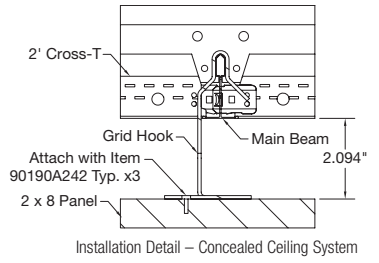

## PHYSICAL DATA

**Material**  
Aluminum composite – 0.57" thick

**Surface Finish**  
Factory-applied powder-coated finish (post-coated)

**Acoustical Performance**  
MetalWorks™ Concealed perforated panels provide outstanding sound absorption. NRC 0.95 achieved with acoustical infill Item 5823. See CS-4172 for more information on infill panels.

**Fire Performance**  
Class A: ASTM E84 surface burning characteristics. Flame Spread Index 25 or less. Smoke Developed 50 or less.

**Installation Considerations**  
Please refer to installation instructions LA-297890 before installing MetalWorks Concealed panels.  
Not made for SingleSpan™ corridor applications.

**Seismic Restraint**  
MetalWorks Concealed panels have been engineered, tested, and approved for application in all seismic areas when installed per Armstrong installation instructions.

**Cleaning and Disinfecting**  
Cleaning and CDC approved disinfecting options available on armstrongceilings.com/cleaning

**Warranty**  
Details at armstrongceilings.com/warranty

**Weight: Square Feet/Carton**  
0.97 lbs/SF (Bulk packaged)



METALWORKS™ – Standard