

# SLOPED CEILING

TECHNICAL AND  
INSTALLATION GUIDE

Inspiring Great Spaces®

**Armstrong**®  
CEILING SOLUTIONS

# SLOPED CEILINGS TECHNICAL GUIDE

## ARMSTRONG® CEILING PANELS ACCEPTABLE IN SLOPED INSTALLATIONS

Mineral Fiber Lay-in, Tegular, and Vector® Ceiling Panels  
Fiberglass Lay-in, Tegular, and Vector Ceiling Panels  
MetalWorks™ Tegular and Vector Ceiling Panels  
WoodWorks® Tegular Ceiling Panels

*[Not all panel sizes can be installed in a sloped configuration. Panels over 4' in length must be evaluated on a case by case basis.]*

## ARMSTRONG SUSPENSION SYSTEMS ACCEPTABLE IN SLOPED INSTALLATIONS



Prelude® XL®



Suprafine® XL



Silhouette® 1/4" XL



Silhouette® 1/8" XL



Interlude® XL

## ACCESSORIES:

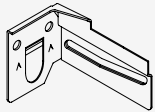

**BERC2 —**  
Beam End Retaining Clip

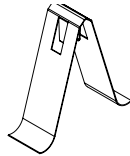

**PMHDC —**  
Maximum Hold Down Clip



**7808 2" Angle Molding**

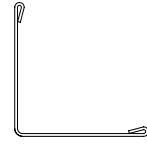

**7800 Hemmed Angle**

## WALL MOLDINGS:

## IMPORTANT SAFETY INFORMATION

Safe installation of a sloped ceiling requires project specific evaluation for compliance with building codes. The final design and installation parameters are the responsibility of the design team. Armstrong has evaluated certain design configurations and supplied the following recommendations based on our testing:

- The maximum ceiling slope shall not exceed 30°
- Use of a maximum hold down clip is required for all sloped ceiling applications except Metalworks Vector which have integrated spring clips in the panel.
- Main beams **MUST NOT** be installed perpendicular to the slope as this may result in suspension system failure.
- Main beams must be spaced a maximum of 4' on center.
- Panels installed at a slope will tend to slide downhill. Shims must be used to prevent this.
- Vector panels **MUST** be installed with the access kerf (side A) oriented toward the top of the slope. Panels may fall out if not configured with the A side at the top of the slope.
- Maintenance personnel who may be removing and replacing specific panels must be trained on how to properly replace the panel with proper clips and orientation.

## GENERAL

Designing and installing a sloped suspended ceiling can provide the opportunity to enhance daylighting, conserve energy, and contribute to LEED EQ Daylighting credits.

Sloped ceilings are not addressed in current building codes. Current building code states that suspended ceiling main beams must be leveled to within 1/4" on a 10' span. Alternate designs are acceptable when approved by the Authority Having Jurisdiction. This is the responsibility of the Project Design Team.

**Actual construction of a sloped suspended ceiling may require engineering documents by code officials/ authorities having jurisdiction in your area.**

Armstrong Ceilings has examined sloped ceilings utilizing ceiling panels for Seismic Design Categories C, D, E, F. We have conducted full-scale seismic shake table testing on multiple sloped ceiling designs at the Structural Engineering Earthquake Simulation Lab located at the State University of New York at Buffalo. Armstrong Ceilings can provide documentation of these test results to design professionals, code officials, and building departments on a project specific basis in the form of a Seismic White Paper. For more information on seismic design, please reference our *Seismic Design: What You Need to Know Brochure*.

Since each sloped ceiling design is unique, general detail drawings accompany these guidelines. Project shop drawings are the responsibility of the contractor. The structural engineer of record is responsible for verifying and approving the use of Armstrong Ceilings components in these unique installations.

## SLOPED CEILING INSTALLATION GUIDELINES

The following guidelines are in addition to the requirements set forth in ASTM C636 and ASCE 7.

### ANGLE GUIDELINES

- Maximum ceiling slope angle shall not exceed 30°.

### MAXIMUM HOLD DOWN CLIP GUIDELINES

The Maximum Hold Down Clip is required for all sloped ceiling applications except MetalWorks™ Vector ceiling panels which have integrated spring clips in the panel.

#### Metalworks Vector Spring Clip

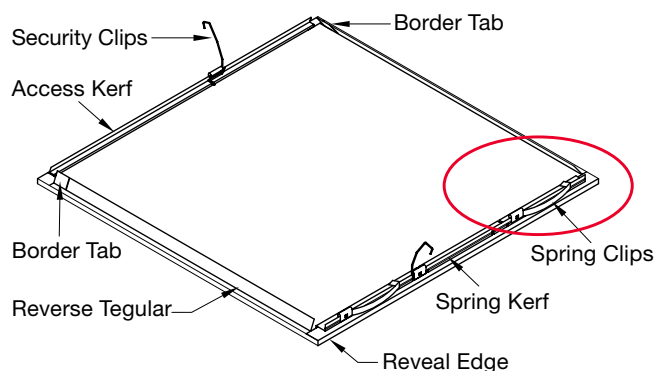

- The use of the Maximum Hold Down Clip will reduce the accessibility of the panel.

# SLOPED CEILINGS TECHNICAL GUIDE

## SHIM GUIDELINES

- Panels will tend to slide downhill, especially on steeper angles.
- If needed, place 1/8" or 3/32" shims (depending on panel type) between the panel edge and the web of the cross tee at the lower edge of each panel to center the panel in the suspension system opening.

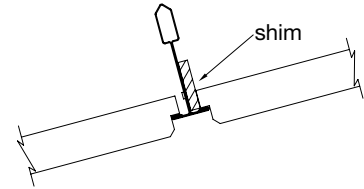

## SUSPENSION SYSTEM GUIDELINES

- Install main beams parallel (up/down the incline) the slope.
- DO NOT INSTALL MAIN BEAMS PERPENDICULAR TO THE SLOPE AS THIS MAY RESULT IN SUSPENSION SYSTEM FAILURE.
- Main beams should be spaced 4'-0" on center, maximum.
- If I-beams, joists, or trusses are running up the slope and do not have purlins between them, bridge the beams, joists, or trusses with a material capable of supporting the ceiling system load.

## HANGER WIRE GUIDELINES

- 12 gauge hanger wire must comply with ASTM C636 requirements.
- Hanger wires should be suspended vertically and plumb.
- If lateral force bracing is required in severe seismic areas, it shall remain vertical and the splay wires shall be installed at maximum 45° to the horizontal.

### Lateral Force Bracing (Compression Posts and Splay Wires)

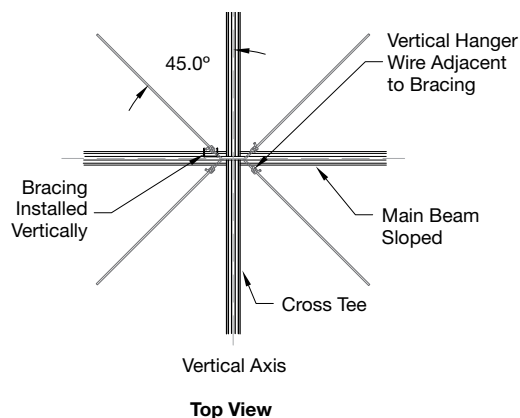
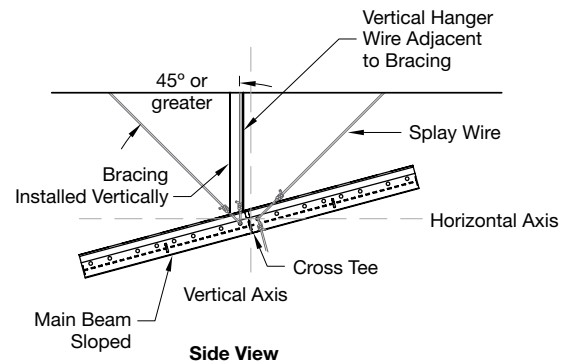
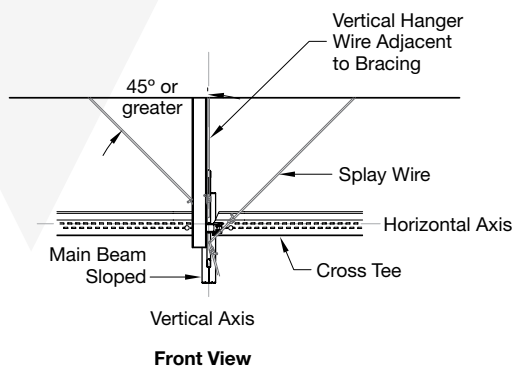

## PERIMETER TREATMENT GUIDELINES

### Sloped Ceilings Perimeter Solution Matrix

Suspended Ceiling Slope	Non-Seismic Areas		Seismic Cat. C, D, E, F
	Option 1	Option 2	Option 3
Up to 30°	Field Modified 2" Item 7808 Wall Angle with positive cross tee attachment at all ends	Wall shim with 7/8" Item 7800 Wall Angle kept at 90° with positive cross tee attachment at all ends	SEISMIC RX solution – Wall shim with 7/8" Item 7800 Wall Angle kept at 90° and BERC2 Clip with positive cross tee attachment on adjacent attached walls

## PERIMETER TREATMENT GUIDELINES

### Perimeter Solution Options

- OPTION 1:** Wall angles at the top and bottom of the slope should be re-bent to the correct angle by the contractor or at a local sheet metal shop.
  - 2" wall angle Item 7808 should be used. **NOTE:** If 7/8" molding is field bent upwards, the result is no room to mount your cross tees to the angle, unless you back cut the web and bulb severely, which impacts loading.
- OPTION 2:** Wall angles are painted and wall shimmed to achieve the correct angle.
  - 7/8" wall angle Item 7800 should be used.
  - The field crafted wall shim must keep the angle 90° to the slope.
- OPTION 3 (SEISMIC):** Wall angles are painted and wall shimmed to achieve the correct angle.
  - 7/8" wall angle Item 7800 should be used.
  - The field crafted wall shim must keep the angle 90° to the slope in order to use Seismic Rx® BERC2 clips.

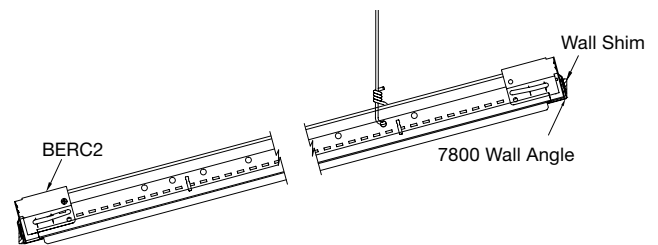
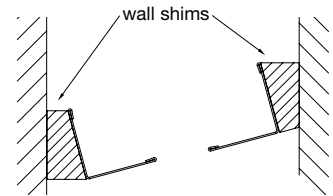
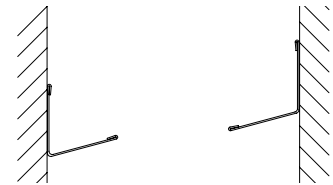

## FLOATING SLOPED CEILING PERIMETERS

- Non-Seismic Considerations: Refer to ASTM C636 for standard practice for installation.
- Seismic Considerations: If sloping a floating cloud, project specific engineering is required.

## VECTOR® CEILING PANEL CONSIDERATIONS

- Ultima® and Optima® Vector ceiling panels in a sloped installation must have the access kerf (A) oriented towards the **top of the slope**.

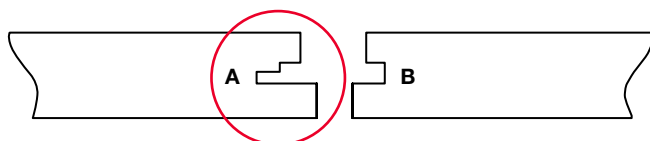

# SLOPED CEILINGS TECHNICAL GUIDE

## QUICK REFERENCE GUIDE FOR SEISMIC SLOPED CEILINGS

Panel Type	Mineral Fiber and Fiberglass Lay-In, Tegular, and Vector Ceiling Panels		Woodworks® Tegular Panels*	
	Metalworks™ Tegular and Vector Ceiling Panels			
Seismic Category	Seismic C	Seismic D,E, F	Seismic C	Seismic D,E,F
Grid ASTM Class	Intermediate Duty (0° < slope < 15°) Heavy - Duty (15° < slope < 30°)	Heavy - Duty	Heavy - Duty	Heavy - Duty
Perimeter Support Wires 8" or Less from Wall	None Required	Required	None Required	Required
Wall Clearance	3/8"	3/4"	3/8"	3/4"
Minimum Wall Molding Width	7/8"	2" or 7/8" with BERC2 Clip	7/8"	2" or 7/8" with BERC2 Clip
Fastened Perimeter Tee Connections	Required	Required	Required	Required
Lateral Force Bracing (splay wires/rigid bracing) for Ceiling Areas > 1,000 ft²	None Required	Required	None Required	Required
Compression Posts for Ceiling Areas > 1,000 ft²	None Required	Required	None Required	Required
Seismic Separation Joints for Ceiling Areas > 2,500 ft²	None Required	Required	None Required	Required
Maximum Weight per ft²	3.0 lbs/ft² (Intermediate-Duty Grid) 4.0 lbs/ft² (Heavy-Duty Grid)	4.0 lbs/ft²	4.0 lbs/ft²	4.0 lbs/ft²
Maximum Hold Down Clip Configuration	See page 9 for layout configuration	See page 10 for layout configuration	See page 9 for layout configuration	See page 10 for layout configuration

\*Safety cables are required for 2' x 4' and 2' x 6' panels

## QUICK REFERENCE GUIDE FOR NON-SEISMIC SLOPED CEILINGS

### Non-Seismic Sloped Ceiling Requirements

Grid ASTM Class	Intermediate-Duty or Heavy-Duty
Perimeter Support Wires 8" or Less from Wall	None Required
Wall Clearance	None Required
Minimum Wall Molding Width	None Required
Fastened Perimeter Tee Connections	None Required
Lateral Force Bracing (splay wires/rigid bracing) for Ceiling Areas > 1,000 ft²	None Required
Compression Posts for Ceiling Areas > 1,000 ft²	None Required
Seismic Separation Joints for Ceiling Areas > 2,500 ft²	None Required
Maximum Hold Down Clip Configuration	None required.

Seismic Categories C, D, E, F Sloped Ceiling Layouts for Mineral Fiber and Fiberglass Lay-In, Tegular, Vector and Concealed Ceiling Panels and Metalworks™ Tegular and Vector Ceiling Panels

Seismic Category C Sloped Ceiling Layout for Slopes  $\leq 15^\circ$

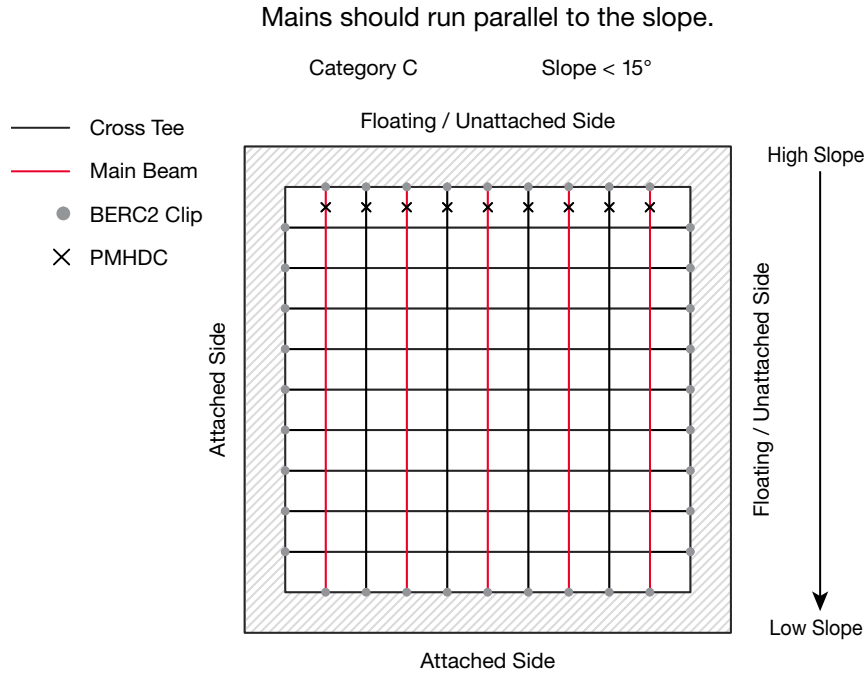

Seismic Category C Sloped Ceiling Layout for  $15^\circ < \text{Slope} \leq 30^\circ$

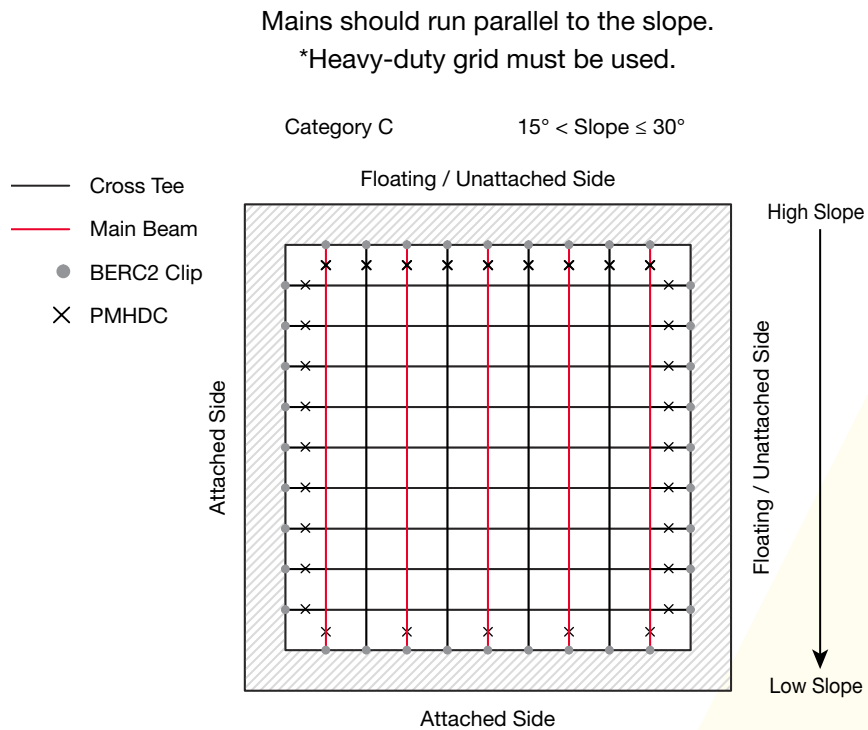

# SLOPED CEILINGS TECHNICAL GUIDE

## SLOPED CEILING LAYOUTS

### Seismic Category D, E, F Sloped Ceiling Layout for Slopes $\leq 15^\circ$

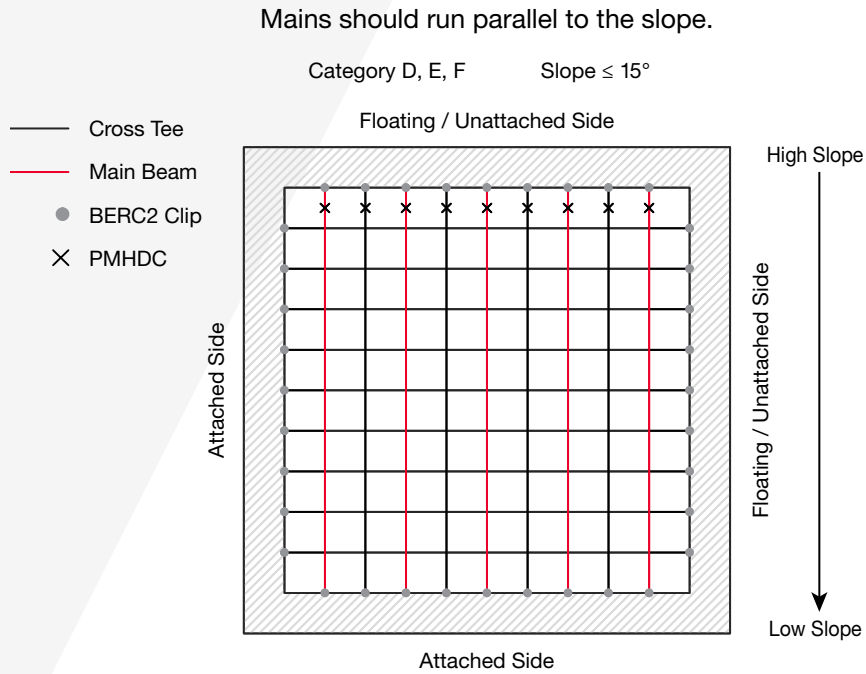

### Seismic Category D, E, F Sloped Ceiling Layout for $15^\circ < \text{Slope} \leq 30^\circ$

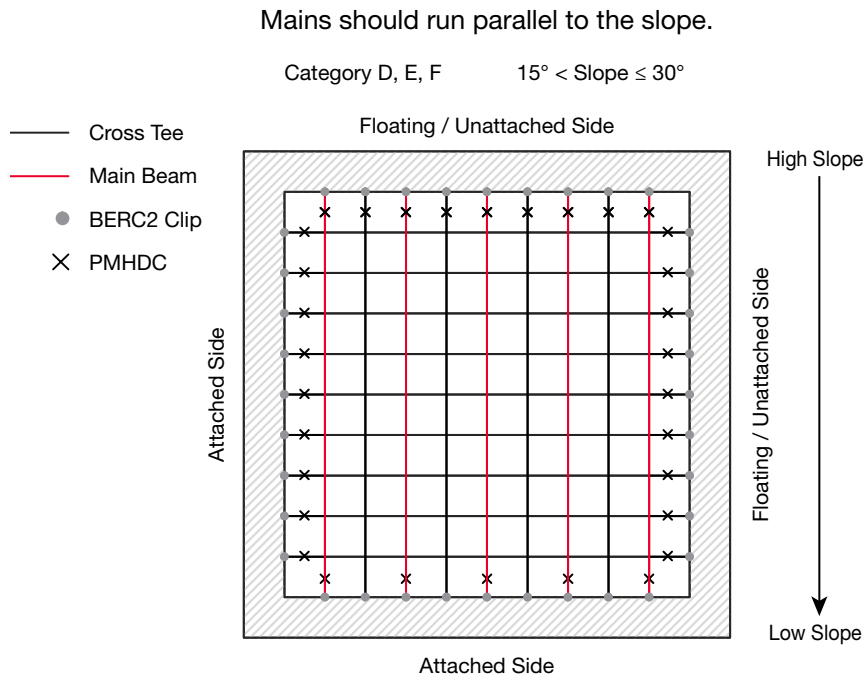



### Woodworks Tegular Seismic Category C, D, E, F Sloped Ceiling Layout for $0^\circ < \text{Slope} \leq 30^\circ$

Mains should run parallel to the slope.

WoodWorks Tegular  $0^\circ < \text{Slope} \leq 30^\circ$   
Category C, D, E, F

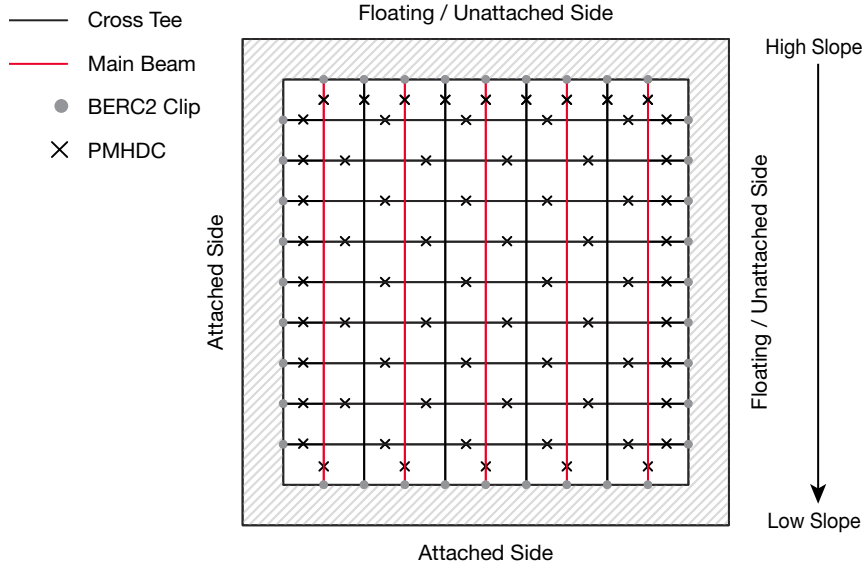

**1 877 276 7876**

Customer Service Representatives  
7:45 a.m. to 5:00 p.m. EST  
Monday through Friday

**TechLine** – Technical information, detail drawings, CAD design assistance, installation information, other technical services – 8:00 a.m. to 5:30 p.m. EST, Monday through Friday. FAX 1 800 572 8324 or email: [techline@armstrongceilings.com](mailto:techline@armstrongceilings.com)

**[armstrongceilings.com/commercial](http://armstrongceilings.com/commercial)**

Latest product news  
Standard and custom product information  
Online catalog  
CAD, Revit®, SketchUp® files  
A Ceiling for Every Space® Visual Selection Tool  
Product literature and samples – express service or regular delivery  
Contacts – reps, where to buy, who will install

**YOU INSPIRE™ SOLUTIONS CENTER**

1 800 988 2585  
email: [solutionscenter@armstrongceilings.com](mailto:solutionscenter@armstrongceilings.com)  
[armstrongceilings.com/youinspire](http://armstrongceilings.com/youinspire)

**Design Assistance**

Collaborative design  
Detail drawings  
Specifications  
Planning and budgeting

**Pre-construction Assistance**

Layout drawings for standard and premium products  
Project installation recommendations  
Contractor installation assistance

**you inspire™**  
solutions center

helping to bring your one-of-a-kind ideas to life

Inspiring Great Spaces™ is a trademark of AFI Licensing LLC; Lutron® is a registered trademark of Lutron Electronics Co., Inc.; All other trademarks used herein are the property of AFI Licensing LLC and/or its affiliates  
© 2018 AFI Licensing LLC • Printed in the United States of America

**TechLine<sup>SM</sup> / 1 877 276 7876**  
**[armstrongceilings.com/sloped](http://armstrongceilings.com/sloped)**

Inspiring Great Spaces®

**Armstrong®**  
CEILING SOLUTIONS