

METALWORKS™ Torsion Spring/ Torsion Spring Exterior

smooth texture

*Now with
Create! Custom
Perforations*

CREATE!™

CUSTOM PERFORATIONS



MetalWorks™ Torsion Spring panels with custom perforations in Silverlume with Prelude® XL® 15/16" suspension system (Pgs. 458-459)



Art and acoustics blend with MetalWorks™ Create!™ custom perforated panels. More at: armstrongceilings.com/metalworkscreeate

plus capabilities
to do more

armstrongceilings.com/capabilities
See more photos at:
armstrongceilings.com/photogallery

Large-size concealed panels offer a monolithic visual with 100% downward accessibility.

KEY SELECTION ATTRIBUTES

- new** • Now, transform your images onto custom perforated MetalWorks™ Create!™ ceiling and wall panels for a unique aesthetic plus acoustical performance
- Six Wood Looks Effects™ finishes as well as Reflections™ laminates
- MetalWorks Torsion Spring is part of the Sustain™ portfolio and meets the most stringent sustainability compliance standards today*
- Choose from a variety of standard panel sizes that install with pre-slotted standard 15/16" suspension system
- 48" x 48" panels are available as a premium option (WHA, SIA, and MYA finishes only)
- Interior panels feature swing-down accessibility
- For exterior applications, choose from 24 x 24 x 1-1/2" and 24 x 48 x 1-1/2" standard panel sizes
- Reflections™ laminate finishes provide superior wood-look visual with printed vinyl bonded to aluminum; visuals other than the ones shown are also available
- NRC values up to 0.90 with fiberglass infill panels (select perforation patterns)

COLOR SELECTION Due to printing limitations, shade may vary from actual product.

MetalWorks™ – Interior and Exterior

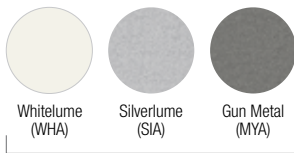

* Part of the Sustain™ portfolio, meeting sustainability compliance standards (M1 – unperforated panels only)

MetalWorks – Interior Only

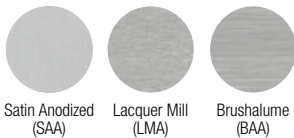

Reflections™ Laminate Finishes – Interior and Exterior



Reflections Laminate Finishes – Interior Only



Effects™ Wood Looks Finishes – Interior Only



PERFORATION OPTIONS (1:2 scale shown)

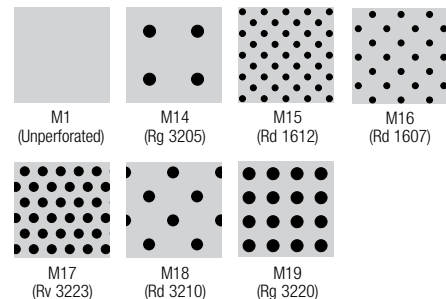

METALWORKS™ Torsion Spring/ Torsion Spring Exterior

smooth texture



DeclareSM
Living Building
Challenge Compliant

SUSTAINSM
High Performance
Sustainable
Ceiling Systems
Unperforated (M1)

UP TO **80%** RECYCLED CONTENT

For LEED contribution contact TechLine

LEED [®]	energy management	construction waste to recycle	regional materials	design for flexibility	EPD	recyclable/extended producer resp.	low embodied materials	recycled content	sourcing of raw materials	material ingredient reporting	low emitting materials	lighting quality	acoustics
-------------------	-------------------	-------------------------------	--------------------	------------------------	-----	------------------------------------	------------------------	------------------	---------------------------	-------------------------------	------------------------	------------------	-----------

VISUAL SELECTION

Edge Profile	Item No. ♦	Dimensions (Inches) W x L x D Custom Sizes Available
METALWORKS™ Torsion Spring Square with Acoustical Fleece		
Torsion Spring Square 15/16" 	7209 _ _ _ _ _	24 x 24 x 1-1/2"
	7210 _ _ _ _ _	24 x 48 x 1-1/2"
	7211 _ _ _ _ _	24 x 72 x 1-1/2"
	7212 _ _ _ _ _	24 x 96 x 1-1/2"
	7213 _ _ _ _ _	30 x 30 x 1-1/2"
Exterior Panels		
Torsion Spring Square 15/16" 	7225 _ _ _ _ _	24 x 24 x 1-1/2"
	7226 _ _ _ _ _	24 x 48 x 1-1/2"

NOTE: 48" x 48" panels are available as a premium option (WHA, SIA, and MYA finishes only)

- ♦ When specifying or ordering, include the appropriate perforation and color suffix with the item number (e.g., 7209 M 1 4 L M A).
- * Light reflectance is for unperforated Whitelume.
- ** Unperforated Whitelume light reflectance
- *** Perforated Whitelume light reflectance

PERFORMANCE

Dots represent high level of performance.

Light Reflect*	Springs per Panel
0.77	4
0.77	4
0.77	6
0.77	6
0.77	4
0.77** 0.61***	4
0.77** 0.61***	4

ACOUSTICAL INFORMATION

Perforation	NRC with acoustical fleece	NRC with 1" fiberglass infill panel ††	
			NRC
M1[†] 	Unperforated	-	-
M14[†] 	Rg 3205	0.55	0.85
M15[†] 	Rd 1612	0.70	0.90
M16[†] 	Rd 1607	0.70	0.80
M17[†] 	Rv 3223	0.70	0.90
M18[†] 	Rd 3210	0.65	0.85
M19[†] 	Rg 3220	0.75	0.90

† Available for exterior applications
†† Maximum NRC achieved with acoustical infill (item 8200T10 or 5823).

For infill panel information, refer to Pg. 156.

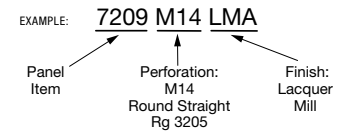

PHYSICAL DATA

Material
Aluminum – thickness 0.040"
Aluminum – thickness 0.060" (item 7226 only)

Surface Finish
Reflections™ laminates: Vinyl-faced membrane
Painted finishes: Factory-applied polyester paint.
Effects™ Wood Looks powder-coated, post-production finishes. Custom colors and finishes available.

Fire Performance
Painted aluminum finishes tested per ASTM E84.
Flame Spread Index 25 or less. Smoke Developed Index 50 or less.

Laminate finishes tested per ASTM E84.
Flame Spread Index 75 or less. Smoke Developed Index 450 or less.

ASTM E1264 Classification
Fire Class A – Painted
Fire Class B – Laminates

Acoustical Options
Perforated panels are supplied with a black fiberglass fleece to absorb sound.

Recycled Content
Minimum 25%. Up to 80% recycled content available.

Code Considerations

The International Mechanical Code requires that materials used in or forming part of an air plenum, have a Flame Spread Rating 25 or less and a Smoke Developed Index 50 or less on all surfaces of the material including those surfaces that may be exposed by cutting the material. Exception: The IBC states, "Materials having a thickness less than 0.036 inches (0.9mm) applied directly to the surface of walls or ceilings shall not be required to be tested." Panels finished with Reflections laminates and paint finishes typically have a thickness less than 0.036 inches (0.9mm). These finishes are applied directly to the Class A aluminum substrate.

Design Considerations

Anodized and Lacquer Mill finishes may vary in shade between production runs as well as over time. Sizes can be mixed and matched on non-perforated panels only. 30" x 30" panels have a directional finish that is perpendicular to the main beams; all other panel sizes have a directional finish that is parallel to the main beams. MetalWorks™ steel and aluminum panels are made at different manufacturing facilities that use different paint systems. Because of this, similar colors, i.e., White and Whitelume, are not exact color matches. Please consider this when designing adjacent spaces with multiple MetalWorks products.

Wind Uplift Performance

24" x 24" and 24" x 48" panels noted for exterior flat applications tested for wind uplift Classes 30, 60, and 90. Specific installation instructions to meet these classes are available.

For more information, visit armstrongceilings.com or contact TechLine customer support at 1 877 276-7876.

Design Support

Project management assistance is available by calling TechLine customer support at 1 877 276-7876.

Seismic Restraint

MetalWorks Torsion Spring panels have been engineered, tested, and approved for application in all seismic areas when installed per Armstrong Ceilings installation instructions.

Warranty

One (1) year limited warranty.
Details at armstrongceilings.com

Weight

0.69 lbs/SF
0.86 lbs/SF (item 7226)

METALWORKS™ Torsion Spring/ Torsion Spring Exterior

Installation Details

HOW TO INSTALL PANELS

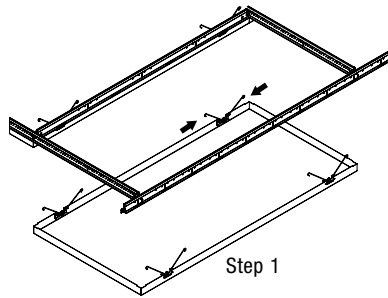

Step 1

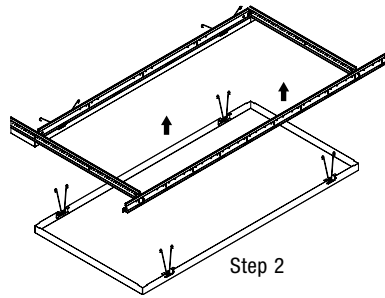

Step 2

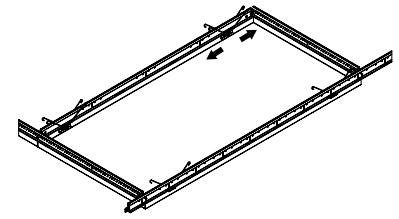

Step 3

INTERIOR INSTALLATION DETAILS – For exterior details, consult the MetalWorks™ Exterior Torsion Spring installation instructions, BPLA-297922, on our web site.

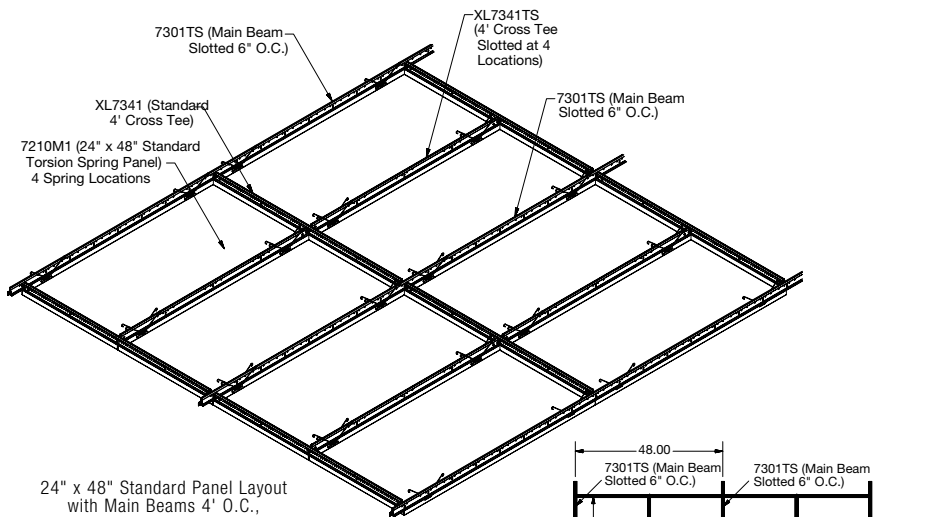

24" x 48" Standard Panel Layout
with Main Beams 4' O.C.,
Standard 4' Prelude® XL® Cross Tees,
4' Slotted Cross Tees

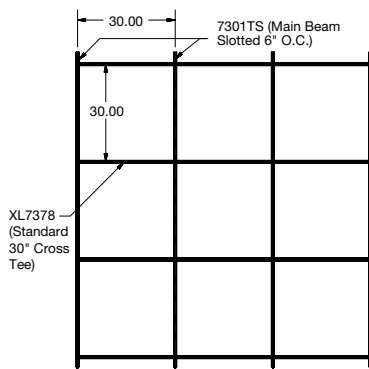

XL7378
(Standard
30" Cross
Tee)

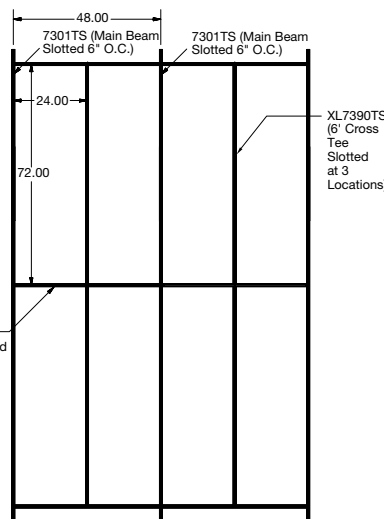

XL7341
(Standard
4' Cross
Tee)

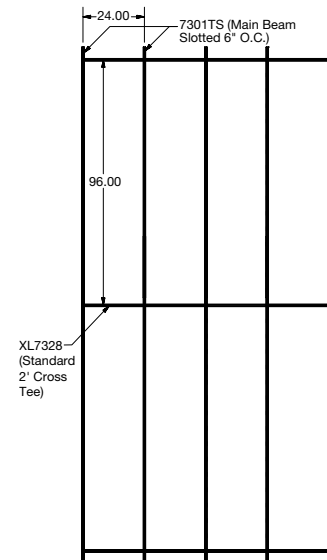

XL7328
(Standard
2' Cross
Tee)

2x8 Grid Layout (Scale - 1:25)

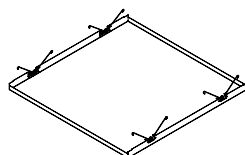

Suspension System Layout
for 30" x 30" Panels

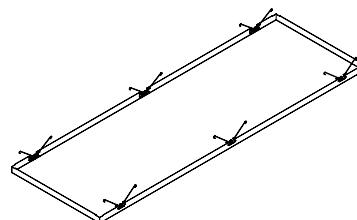

Suspension System Layout
for 24" x 72" Panels

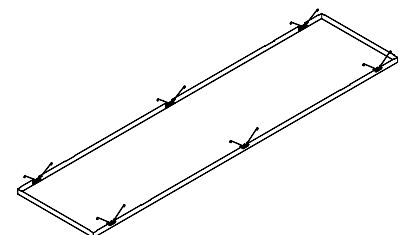

Suspension System Layout
for 24" x 96" Panels



METALWORKS™ Torsion Spring/ Torsion Spring Exterior

Perimeter Details

INTERIOR WALL PERIMETER DETAILS – For exterior details, consult the MetalWorks™ Exterior Torsion Spring installation instructions, BPLA-297922, on our web site.

Installation Detail – Wall Perimeter

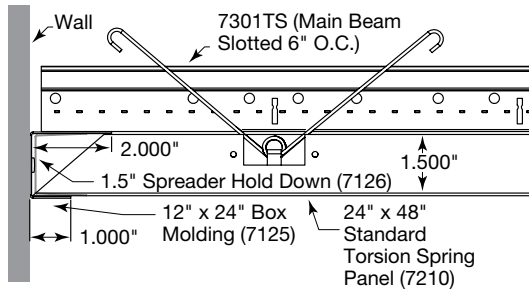

**Installation Detail – Perimeter Trim
(Formed Trim #7131)**

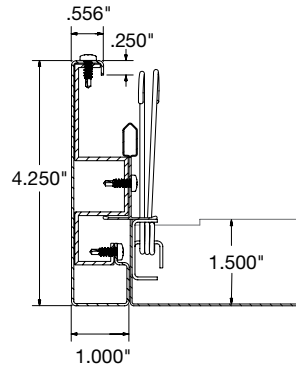

**Installation Detail – Perimeter Trim
(Extruded Trim #7147)**

Full Panels

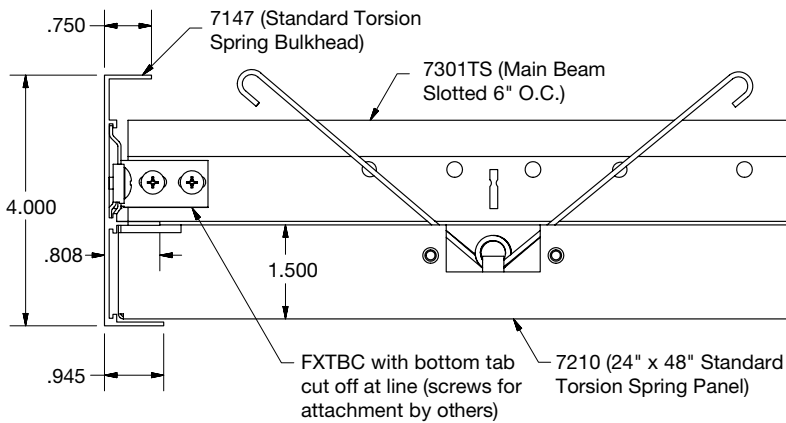

Cut Panels

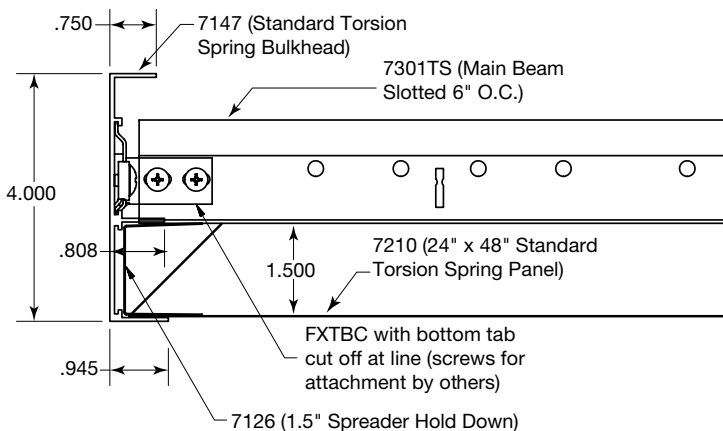

METALWORKS™ Torsion Spring/ Torsion Spring Exterior

Accessories & Suspension Systems

ACCESSORIES

Item No. ♦	Description	Dimensions (Inches) Nominal W x L x H	Color	Pieces/ Carton
7125_ _ _	Box Molding (for Laminates, Black is recommended)	2 x 96 x 1-1/2"	WHA, SIA, MYA, SAA, LMA, BAA, BL	10
7147_ _	Torsion Spring Perimeter Trim (Extruded) (for Laminates, Black is recommended)	1 x 120 x 4"	WH, SG, MY, BL*	6
7131_ _ _	Torsion Spring Perimeter Trim (Formed)	1 x 96 x 4-1/4"	LMA, BAA, SAA	6
7126	Spreader Hold Down	1 x 10-5/8 x 1-1/2"	N/A	10
5823	BioAcoustic™ Infill Panel	24 x 24 x 5/8"	Black	12
8200T10	1" Fiberglass Infill Bag	24 x 24 x 1"	Black (Gloss)	12
7129	Torsion Spring Hook Access Tool	N/A	N/A	1
7130	Torsion Spring Suction Access Tool	N/A	N/A	1

♦ When specifying or ordering, include the appropriate color code with the item number (e.g. 7131 K M A)

* Coordinates with WHA, SIA, MYA Torsion Spring Panel finish

SUSPENSION SYSTEMS

Item No.	Description	Dimensions (Inches)
15/16" Prelude® XL® Suspension System – Some items slotted for Torsion Spring. See below.		
7301TS	Prelude XL 12' HD Main Beam – slotted for Torsion Spring	144 x 15/16 x 1-11/16"
XL7341TS	Prelude XL 4' Cross Tee – slotted for Torsion Spring	48 x 15/16 x 1-11/16"
XL7390TS	Prelude XL 6' Cross Tee – slotted for Torsion Spring	72 x 15/16 x 1-11/16"
XL7378	Prelude XL 30" Cross Tee	30 x 15/16 x 1-11/16"
XL8320	Prelude XL 2' Cross Tee	24 x 15/16 x 1-11/16"
XL7341	Prelude XL 4' Cross Tee	48 x 15/16 x 1-11/16"
Exterior Suspension System		
15/16" Prelude XL – Some items slotted for Torsion Spring. See below.		
7301G90ATS	Prelude XL 12' HD Exterior Main Beam – slotted for Torsion Spring	144 x 15/16 x 1-11/16"
XL7341G90ATS	Prelude XL 4' Exterior Cross Tee – slotted for Torsion Spring	48 x 15/16 x 1-11/16"
XL7321G90A	Prelude XL 2' Exterior Cross Tee	24 x 15/16 x 1-11/16"

LEED® is a registered trademark of the U.S. Green Building Council
 Declare™ is a service mark of International Living Future Institute
 Revit® is a registered trademark of Autodesk, Inc.
 All other trademarks used herein are the property of AWI Licensing LLC
 and/or its affiliates © 2020 AWI Licensing LLC
 Printed in the United States of America

