

new AXIOM® Indirect Light Ledge



Declare.

50% RECYCLED CONTENT

Calculate LEED contribution at armstrongceilings.com/greengenie

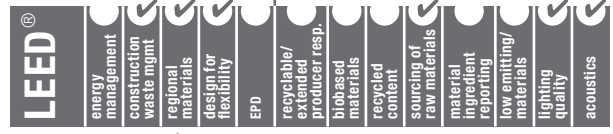

LOCATION DEPENDENT

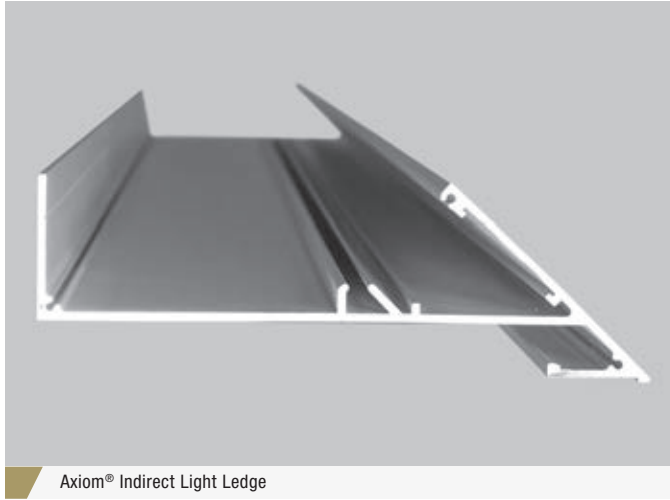

Axiom® Indirect Light Ledge

KEY SELECTION ATTRIBUTES

- Axiom® Indirect Light Ledge offers predictable lighting performance
- Axiom Indirect Light Ledge is part of the Sustain™ portfolio and meets the most stringent sustainability compliance standards today
- With our lighting partners, this pre-engineered solution offers a variety of options with both Ceiling-to-Wall and Ceiling-to-Ceiling light ledges
- 10-Year Limited Warranty, 30-Year System Warranty

LIGHTING FIXTURES

Compatible with:
Axis Lighting and Vode® Lighting,



COLOR



VISUAL SELECTION

STRAIGHT

Specify Indirect Light Ledge Item Number
Example: AXILLCWKD – Axiom Light Ledge, Ceiling-to-Wall, Knife Edge

Light Cove Type*	Mounting	Edge Detail
<input type="checkbox"/> AXILL __	--	--
	CC – Ceiling-to-Ceiling CW – Ceiling-to-Wall	2D – 2" Classic Edge Drywall KD – Knife Edge Drywall

* Light Ledges are 10' lengths

DETAILS

Ceiling-to-Wall

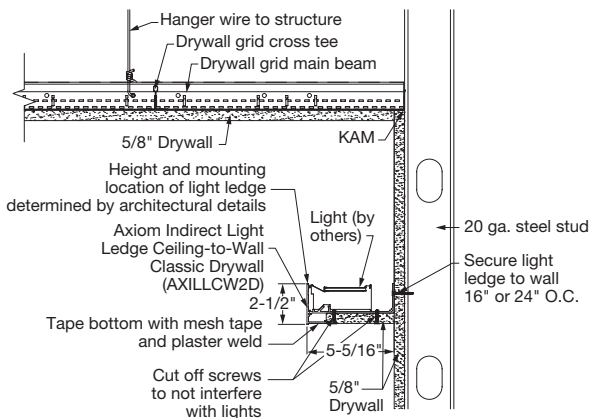

Knife Edge Ceiling-to-Ceiling

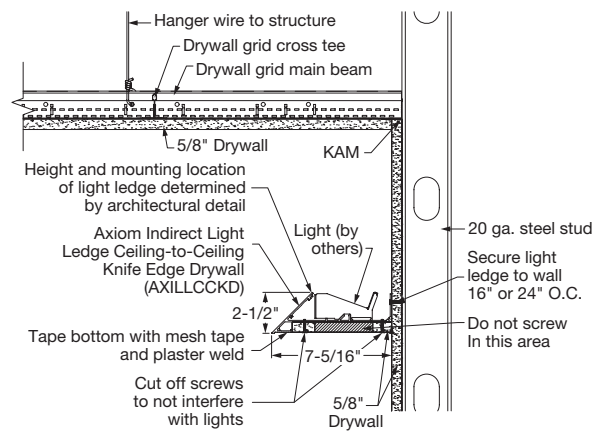

Ceiling-to-Wall

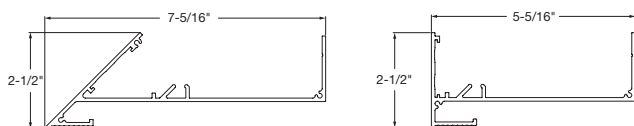

Knife Edge Ceiling-to-Wall

Classic Ceiling-to-Wall

Ceiling-to-Ceiling

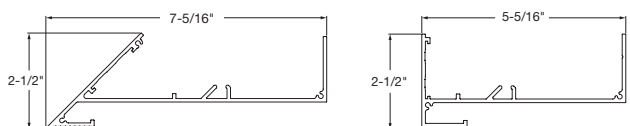

Knife Edge Ceiling-to-Ceiling

Classic Ceiling-to-Ceiling

VISUAL SELECTION

Specify Indirect Light Ledge Item Number (NOTE: only use this section if you need corners or end returns on your project)

Example: AXILLCWKDIC – Axiom Light Ledge, Ceiling-to-Wall, Knife Edge, Inside Corner

CORNERS

Light Cove Type*	Mounting	Edge Detail	Options
<input type="checkbox"/> AXILL __	--	--	--
	CC – Ceiling-to-Ceiling CW – Ceiling-to-Wall	2D – 2" Classic Edge Drywall KD – Knife Edge Drywall	IC – Inside Corner OC – Outside Corner

* Light Ledge corners are 12" in length and 12" in width

Knife Edge® Profiles – Corners

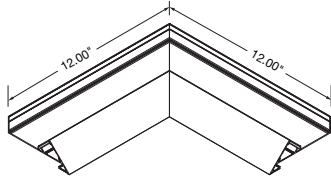

Knife Edge Ceiling-to-Wall Inside Corner

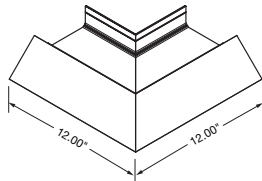

Knife Edge Ceiling-to-Wall Outside Corner

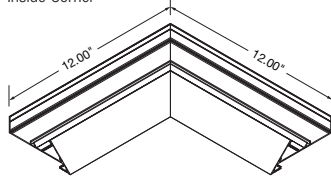

Knife Edge Ceiling-to-Ceiling Inside Corner

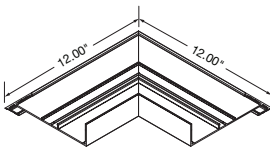

Knife Edge Ceiling-to-Ceiling Outside Corner

Classic Profiles – Corners

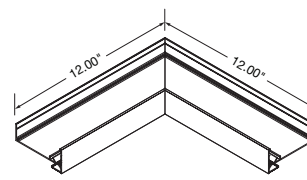

Classic Ceiling-to-Wall Inside Corner

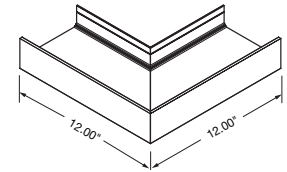

Classic Ceiling-to-Wall Outside Corner

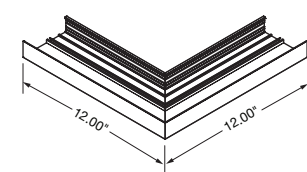

Classic Ceiling-to-Ceiling Inside Corner

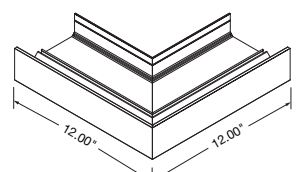

Classic Ceiling-to-Ceiling Outside Corner

END PLATES

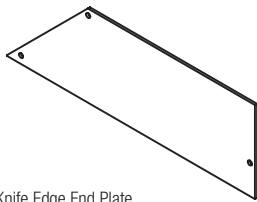

Knife Edge End Plate
 AXILLKDEP

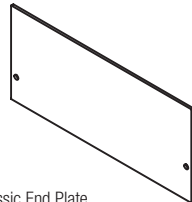

Classic End Plate
 AXILL2DEP

ACCESSORIES

Item No.	Description
<input type="checkbox"/> AX4SPlice	Axiom Splice Plate

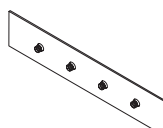

VISUAL SELECTION

Specify Indirect Light Ledge Curved Item Number

Example: AXILLCWKDIC – Axiom Light Ledge, Ceiling-to-Wall, Knife Edge, Inside Corner

CURVED

Light Cove Type*	Edge Detail	Options	MINIMUM BEND RADIUS FOR INDIRECT LIGHT LEDGE Inside: 60" minimum Outside: 60" minimum
<input type="checkbox"/> AXILL __	--	--	
	2D – 2" Classic Edge Drywall KD – Knife Edge Drywall	CUR CUR	

* Light Ledge corners are 12" in length and 12" in width

Knife Edge® Profile – Curved

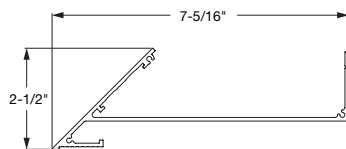

Classic Profile – Curved

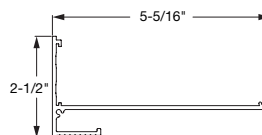

COMPATIBLE LIGHT FIXTURES

CovePerfekt™ by Axis Lighting

For more information: www.axislighting.com

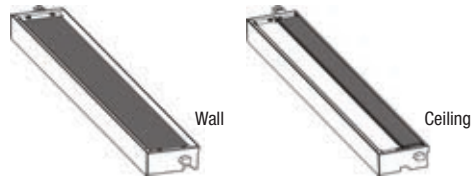

Outstanding Aesthetics

- No shadows. No bright spots. No color shifting.

Easy Specification

- Aim-free luminaire. No need for complex details. Less trade coordination.

Unparalleled Performance

- Twice the efficiency of other LED cove products.
- Wide distribution using SurroundLite™ technology.

Worry-free Installation & Maintenance

- Foolproof keyed mounting. Up to 90% less labor.



ZipWave™ | LED | 707 by Vode® Lighting

Perfect color, perfect beam, perfect alignment... every time

For more information: www.vode.com/zipwave-led-707

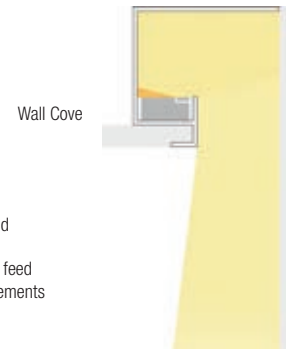

Exceptional Performance

- Low, standard and high outputs available
- High output over 1200 lm/ft.
- Customizable output and wattage options

Foolproof Installation

- Drop-in, tool-free installation with plug and play connections
- Runs 100' or more from one 120v power feed
- Section lengths in exact 1' (305mm) increments



PHYSICAL DATA

Material

Commercial quality 3003 aluminum alloy

Surface Finish

Factory-applied baked polyester paint finish

Warranty

10-Year Limited Warranty; 30-Year System Warranty

Profile

Various options with both Ceiling-to-Wall and Ceiling-to-Ceiling Light Ledges in a wide range of sizes with 3/4" horizontal flange.

Cross Tee/Main Beam Interface

Flush fit

End Detail

Splice with screws

ICC Reports

For areas under ICC jurisdiction, see evaluation report numbers ESR-1289 and ESR-1308 for allowable values and/or conditions of use concerning the suspension system components listed on this page. The reports are subject to reexamination, revisions, and possible cancellation.