



Armstrong® Intersection Downlighting with USAI Lighting Connect™ Family

This pre-engineered suspension system seamlessly integrates recessed downlights at the intersection of the ceiling grid-placing light where it has never been before.

**KEY SELECTION ATTRIBUTES**

- Lighting and architecture perfectly integrated into the ceiling to deliver your vision of symmetry
- Replaces inconsistent finishes and edge details with clean crisp factory finished panels and grid for a fast and easy installation
- Compatible with the USAI Lighting CONNECT™ Family
- Eliminates the worry of field modified panels and grid
- Seismic code compliant
- Armstrong 10-Year Limited Warranty

**TYPICAL APPLICATIONS**

- Open & Closed Offices
- Lobbies
- Training Rooms
- Corridors
- Conference Rooms

Lighting Partner:



Follow the below three (3) steps when specifying Intersection Downlighting:

**1. Choose your ceiling system layout**

2' x 2' Ceiling layout with lights 4' apart

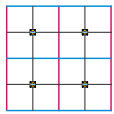

2' x 2' Ceiling layout with lights 6' apart

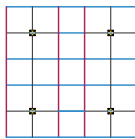

2' x 2' Ceiling layout with lights 8' apart

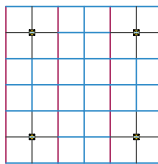

30" x 30" Ceiling layout with lights 5' apart

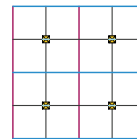

30" x 30" Ceiling layout with lights 7-1/2' apart

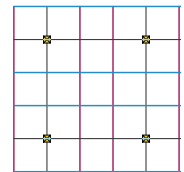

**2. Choose your 9/16" Intersection Profile Downlighting Kit (main beams, standard cross tees, wall molding, and lights need to be ordered separately)**

Item No.	Description
----------	-------------

Choose Hub Kit, then appropriate cross tee module.

**Silhouette® XL® 1/4" Reveal**

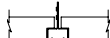

<input type="checkbox"/> <b>76D4SK_</b>	4" Downlight Hub Kit w/ Yokes & hardware
<input type="checkbox"/> <b>XL7622DL_</b>	24" Module Downlight Cross Tee
<input type="checkbox"/> <b>XL7628DL_</b>	30" Module Downlight Cross Tee

\* 8" Cross tee – Notched 48" O.C. available Made-to-Order

**Silhouette® XL 1/8" Reveal**

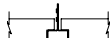

<input type="checkbox"/> <b>768D4SK_</b>	4" Downlight Hub Kit w/ Yokes & hardware
<input type="checkbox"/> <b>XL76822DL_</b>	24" Module Downlight Cross Tee
<input type="checkbox"/> <b>XL76828DL_</b>	30" Module Downlight Cross Tee

\* 8" Cross tee – Notched 48" O.C. available Made-to-Order

**Suprafine® XL®**

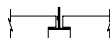

<input type="checkbox"/> <b>75D4SK_</b>	4" Downlight Hub Kit w/ Yokes & hardware
<input type="checkbox"/> <b>XL7522DL_</b>	24" Module Downlight Cross Tee
<input type="checkbox"/> <b>XL7528DL_</b>	30" Module Downlight Cross Tee

**Interlude® XL® HRC**



<input type="checkbox"/> <b>61D4SK_</b>	4" Downlight Hub Kit w/ Yokes & hardware
<input type="checkbox"/> <b>XL6122DL_</b>	24" Module Downlight Cross Tee
<input type="checkbox"/> <b>XL6128DL_</b>	30" Module Downlight Cross Tee

†† Add the 2-letter color suffix to the item number when specifying or ordering (Example: AX2WEC Z\_W)

Item No.	Description
----------	-------------

**Accessories**

<input type="checkbox"/> <b>FZD4YKLP</b>	Low-Profile Yoke
<input type="checkbox"/> <b>SH1206</b>	PeakForm® Support Hanger with Routing 6" O.C.

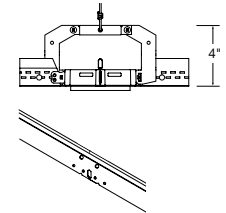

**COLORS**



**Kit Components Included: (8 Kits per carton)**

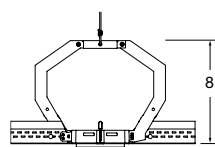

(1) High-Profile Yoke (not assembled – comes in two pieces)\*



(2) Cross Tee Connection Clips

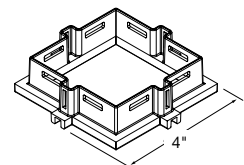

(1) Downlight Suspension Frame

\* Alternate low profile yoke for low plenum applications available – Item #: FZD4YKLP

**INTERSECTION DOWNLIGHTING ASSEMBLY/CEILING PANEL LAYOUT**

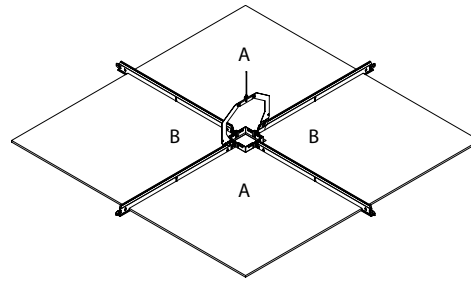
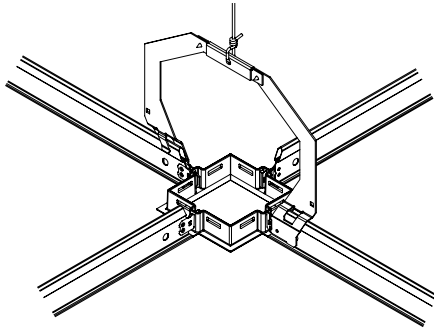

**3. Choose your Ceiling Panel – Size & Finish**

**NOTE:** These are directional panels and come as (8) pieces per carton – 4 each, A and B (marked)

**VISUAL SELECTION**

**PERFORMANCE SELECTION** Dots represent high level of performance.

Edge Profile	Item No.	Dimensions (Inches)	NRC	CAC	Total Acoustics <sup>1</sup> NRC + CAC	Articulation Class AC	Fire Rating	Light Reflect	Anti-Mold & Mildew	Sag Resist	Certified Low VOC Emissions	Wash	Impact	Scratch	Soil	Recycled Content	Recycle Program	30-Yr Warranty	
<b>CALLA® Notched Ceiling Panels</b> (8 panels per carton)																			
9/16" Square Tegular	<b>2818</b>	24 x 24 x 1"	0.85	35	<b>BEST</b>	170	Class A	0.86	•	•	•	•	•	•	•	•	•	•	•
<b>CALLA Compatible Full Size Panels</b>																			
9/16" Square Tegular	<b>2824</b>	24 x 24 x 1"	0.85	35	<b>BEST</b>	170	Class A	0.86	•	•	•	•	•	•	•	•	•	•	•

<sup>1</sup> Total Acoustics™ ceiling panels have an ideal combination of noise reduction and sound-blocking performance in one product. **GOOD** (NRC 0.60-0.65; CAC 35+) **BETTER** (NRC 0.70-0.75; CAC 35+) **BEST** (NRC 0.80+; CAC 35+)

**Intersection Downlighting Ceiling Panels/1 Notch**

Edge Detail	Visual	Size
9/16" <b>Made-to-Order Sizes (4-6 Wks)</b>	Ultima®	24" x 24"
	Ultima High NRC	24" x 24"
	Calla®	30" x 30"

**INTERSECTION DOWNLIGHT OFFERING SUSPENSION SYSTEMS\*†**

Grid	Panel Size	Edge Detail	Downlight Kit Item #	Downlight Cross Tee Item #
Suprafine®	24" x 24"	9/16"	75D4SK	XL7522DL
	30" x 30"	9/16"		XL7528DL
Silhouette® 1/4	24" x 24"	9/16"	76D4SK	XL7622DL
	30" x 30"	9/16"		XL7628DL
Silhouette 1/8	24" x 24"	9/16"	768D4SK	XL76822DL
	30" x 30"	9/16"		XL76828DL
Interlude®	24" x 24"	9/16"	61D4SK	XL6122DL
	30" x 30"	9/16"		XL6128DL

\* MTO Made-to-Order ceiling panels and grid available in 4 to 6 weeks.  
 † Choose Downlight Kit Item # and Downlight Cross Tee Item #

**CONNECT™ Family**

Connect's distinguished aesthetic and uncompromising craftsmanship integrates beautiful illumination with simplicity.

- Award-winning LED performance
- Three different trim aesthetics available: BeveLED, True Zero, and SilverLED
- Industry-leading color consistency
- Full family of downlight, adjustable and wall wash
- Interchangeable beam spreads
- Best-in-class dimming controls compatibility
- Widest range of white light color options
- Color technologies – Classic White, Warm Glow, Dimming, and Color Select options



For more product information visit:  
[usalighting.com/connect](http://usalighting.com/connect)

**PHYSICAL DATA**

**Material**

Cross Tees: Hot dipped galvanized steel  
 High Profile Yoke: Galvanized steel  
 Low Profile Yoke: Galvanized steel  
 Cross Tee Connector Clip: Galvanized steel  
 Downlight Suspension Frame: ADC12 Aluminum

**Surface Finish**

Baked polyester paint or powder coated finish

**Cross Tee / Downlight Suspension Frame Interface**

Flush

**End detail**

Staked-on XL Clip

**Installation Considerations**

The high-profile yoke included in each kit is designed for use with the USAI Lighting CONNECT Family Downlight, Adjustable, and Wall Wash lighting options.

For low plenum installations, the low-profile yoke can be ordered separately and comes with (8) eight unassembled yokes. The low-profile yoke can be used with the USAI CONNECT Family Downlight and Wall Wash options. A low-profile yoke will not fit the housing of a USAI CONNECT Adjustable downlight and a high-profile yoke must be used.

Downlight Suspension Frame can only receive directional cross tees. For light spacing 6' or 7'-1/2' apart alternate main beam spacing (4' spacing, 2' spacing, 5' spacing, or 2'-1/2' spacing).

**Downlight Hub Kit Components**

Each carton contains (8) eight Intersection Downlighting Kits with the following components:

- (8) High-Profile Yokes (unassembled)
- (8) Downlight Suspension Frames
- (20) Cross Tee Connection Clips (16 clips are required, 4 extra per carton)

**Module Cross Tee Kits**

(32) cross tees per carton

**Warranty**

10-year limited warranty



TechLine / 1 877 276-7876  
[armstrongceilings.com/downlight](http://armstrongceilings.com/downlight)

BPCS-5368-720

LEED® is a registered trademark of the U.S. Green Building Council  
 USAI Lighting, Connect™, BeveLED, True Zero and SilverLED are trademarks of USAI Lighting, LLC; all other trademarks used herein are the property of AWI Licensing LLC and/or its affiliates © 2020 AWI Licensing LLC  
 Printed in the United States of America

