

# AXIOM® Knife Edge®

Trim  
straight

Declare<sup>SM</sup>  
Living Building  
Challenge Compliant

**SUSTAIN™**  
High Performance  
Sustainable  
Ceiling Systems

50% RECYCLED CONTENT  
ALUMINUM

Calculate LEED contribution at  
armstrongceilings.com/greengenie

LEED	energy management	construction waste mgmt	regional materials	design for flexibility	EPD	recyclable/extended producer resp.	biobased materials	recycled content	sourcing of raw materials	material ingredient reporting	low emitting materials	lighting quality	acoustics
------	-------------------	-------------------------	--------------------	------------------------	-----	------------------------------------	--------------------	------------------	---------------------------	-------------------------------	------------------------	------------------	-----------

LOCATION DEPENDENT



This trim is a unique, refined trim alternative compared to traditional, 90-degree vertical trims.

## KEY SELECTION ATTRIBUTES

- Adjustable Trim Clip (Item 7239) makes Knife Edge Trim compatible with WoodWorks® and MetalWorks™ panels or planks that drop greater than 3/8" below the grid flange
- Unique profile provides a refined alternative
- Axiom® trim is part of the Sustain™ portfolio and meets the most stringent sustainability compliance standards today – White and 13 Sustain™ colors only (colors found on Pg. 481)
- Compatible with Armstrong® Suspension Systems and Drywall Grid Systems
- Three profiles available:  
**Axiom® Knife Edge®** for traditional acoustical lay-in and Tegular panels, as well as drywall



- Axiom Knife Edge for Vector®** is specifically made to work with the unique Vector edge
- Axiom® Angled Knife Edge®**: A minimalist knife edge that runs to the edge of a cloud
- Axiom Angled Knife Edge for ACOUSTIBuilt™**: Angled Knife Edge to give a smooth finish to ACOUSTIBuilt seamless acoustical ceiling system
- Extruded aluminum trim provides Acoustibuilt clouds more crisp edge detailing compared to conventional roll-formed steel systems
- Colors coordinate with Armstrong ceiling and suspension systems
- Standard 90° factory bonded corners

**COLORS** Due to printing limitations, shade may vary from actual product.

### Standard

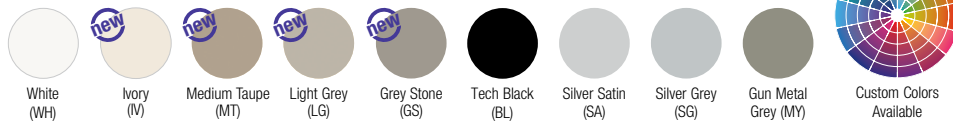

NOTE: 360° paint finishes and custom colors available as special order

### ARCHITECTURAL FILM FINISHES (white or black background)



NOTE: White is standard color for all AXIOM products.

### BLIZZARD WHITE FINISH

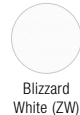

NOTE: Blizzard White finish available on select Axiom® Classic, Knife Edge®, and Vector® trim profiles

## VISUAL SELECTION

Item No. ♦	Description	Dimensions
<b>AXIOM® Knife Edge®</b>		
AXKE2STR_ _ _	Straight	120 x 6-3/16 x 2-1/2"
AXKE90IC*_ _ _	Inside 90° Corner	12 x 6-3/16 x 2-1/2"
AXKE90OC*_ _ _	Outside 90° Corner	12 x 6-3/16 x 2-1/2"
AXKE5STR***	Straight	120 x 6 x 5"
AXKE5IC***	Inside 90° Corner	12 x 6-3/16 x 5"
AXKE5OC***	Outside 90° Corner	12 x 6-3/16 x 5"
<b>AXIOM Knife Edge for Vector®*</b>		
AXKEVE2STR_ _ _	Vector – Straight	120 x 5-9/16 x 2-5/16"
AXKEVE90IC*_ _ _	Inside 90° Corner	12 x 5-9/16 x 2-5/16"
AXKEVE90OC*_ _ _	Outside 90° Corner	12 x 5-9/16 x 2-5/16"

♦ Add the 2-digit color suffix to the item number when specifying or ordering (Example: AX2STR H A), add an extra digit "3" before the color suffix if paint is required inside and outside of trim (Example: AXKE2STR 3 H A), use extra suffix W-white or B-black before color suffix when ordering film to designate the background color (Example: AXKE2STR B B B).

\* Axiom Knife Edge must use factory corners.

\*\* Recommended with 5" Knife Edge. Clip could be visible with 2" trim.

\*\*\* Only available in White.

**DETAILS** For more information, see submittal BPCS-3080.

### Factory-Bonded corners

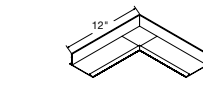

Axiom® Knife Edge® Factory-Bonded Inside Corner (AXKE90IC)

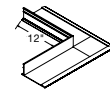

Axiom® Knife Edge® Factory-Bonded Outside Corner (AXKE90OC)

### Factory corner configurations available 60-135° (upon request)

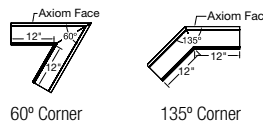

60° Corner

135° Corner

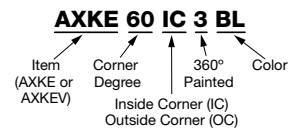

CAD drawings available on [armstrongceilings.com/axiom](http://armstrongceilings.com/axiom)

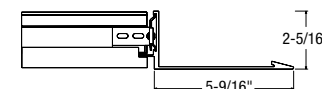

Axiom® Knife Edge® for Vector® profile

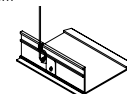

Axiom® Knife Edge® (AX2HGC)

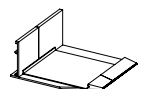

Axiom® Knife Edge® Alignment Clip (AXKEALIGN)

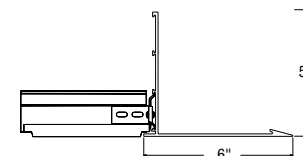

Axiom® Knife Edge® Profile (AXKE5STR)

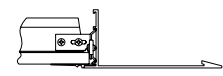

Axiom® Knife Edge® with Drywall (Use with AXVTBC and AXDWT)



TRIM & TRANSITIONS

# AXIOM® Knife Edge®

Trim  
straight



Declare<sup>SM</sup>  
Living Building  
Challenge Compliant

SUSTAIN<sup>®</sup>  
High Performance  
Sustainable  
Ceiling Systems

50% RECYCLED CONTENT

LEED <sup>®</sup>	energy management	construction waste mgmt	regional materials	design for flexibility	EPD	recyclable/extended producer resp.	biobased materials	recycled content	sourcing of raw materials	material ingredient reporting	low emitting materials	lighting quality	acoustics
-------------------	-------------------	-------------------------	--------------------	------------------------	-----	------------------------------------	--------------------	------------------	---------------------------	-------------------------------	------------------------	------------------	-----------

Calculate LEED contribution at [armstrongceilings.com/greengenie](http://armstrongceilings.com/greengenie)

LOCATION DEPENDENT

## VISUAL SELECTION

Item No. ♦	Description	Dimensions
<b>AXIOM® Angled Knife Edge® Trim for Drywall</b>		
AXAKDSTR _ _	Axiom Angled Knife Edge Trim for Drywall	120 x 3 x 3"
AXAKDIC _ _	Axiom Angled Knife Edge Trim for Drywall Inside Corner	12 x 3 x 3"
AXAKDOC _ _	Axiom Angled Knife Edge Trim for Drywall Outside Corner	12 x 3 x 3"
<b>AXIOM® Angled Knife Edge® Trim for Acoustical</b>		
AXAKESTR _ _	Axiom Angled Knife Edge Trim for Acoustical	120 x 3 x 3"
AXAKEIC _ _	Axiom Angled Knife Edge Trim for Acoustical Inside Corner	12 x 3 x 3"
AXAKEOC _ _	Axiom Angled Knife Edge Trim for Acoustical Outside Corner	12 x 3 x 3"

Item No. ♦	Description	Dimensions
<b>AXIOM® Angled Knife Edge® Trim for ACOUSTIBuilt™ Seamless Acoustical Ceiling System</b>		
AXAKEACBSTR _ _	Axiom Angled Knife Edge Trim for ACOUSTIBuilt	120 x 3 x 3"
AXAKEACBIC _ _	Axiom Angled Knife Edge Trim for ACOUSTIBuilt Inside Corner	12 x 3 x 3"
AXAKEACBOC _ _	Axiom Angled Knife Edge Trim for ACOUSTIBuilt Outside Corner	12 x 3 x 3"

Add the 2-digit color suffix to the item number when specifying or ordering (Example: AXLD6STR W H).

## Accessories

AX2HGC	Hanging Clip	-
AXTBC	T-Bar Connector Clip	-
AXVTBC	Vector T-Bar Connector Clip	-
7239**	Adjustable Trim Clip	-
AX4SPICE2	Splice Clip with Screws	-
AXKEALIGN	Alignment Clip	-
AXSPTHDC	Trim Hold-Down Clip	-
AXDWT	Drywall Trim	120 x 1-3/4"

**DETAILS** For more information, see submittal BPCS-3080.

### Axiom® Angled Knife Edge® Trim for Acoustical Panels

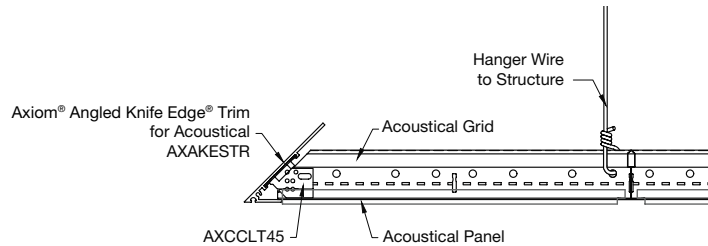
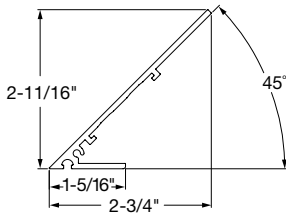

### Axiom Angled Knife Edge Trim for Drywall

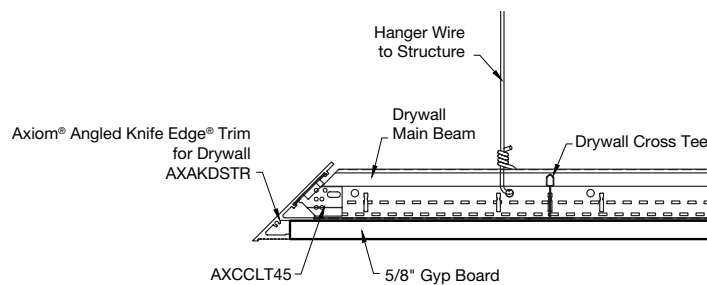
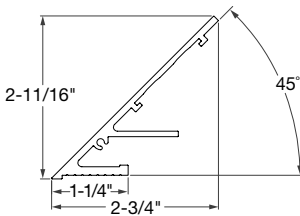

### Axiom Angled Knife Edge Trim for ACOUSTIBuilt™ Seamless Acoustical Ceiling System

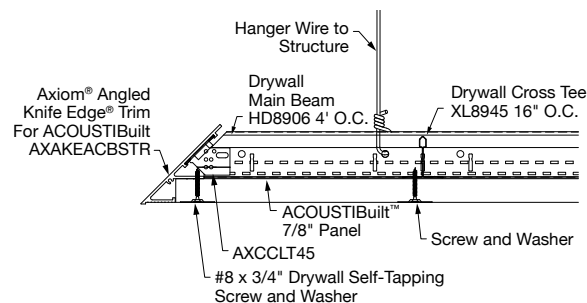
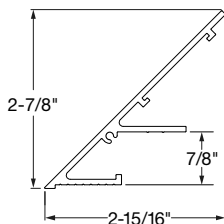

487A

TechLine / 1 877 276-7876  
[armstrongceilings.com/axiom](http://armstrongceilings.com/axiom)

BPCS-3528-620

LEED<sup>®</sup> is a registered trademark of the U.S. Green Building Council<sup>®</sup>  
Declare<sup>SM</sup> is a service mark of The International Living Future Institute.  
All other trademarks used herein are the property of AWI Licensing LLC  
and/or its affiliates © 2020 AWI Licensing LLC  
Printed in the United States of America

**Armstrong**<sup>®</sup>  
CEILING & WALL SOLUTIONS



TRIM & TRANSITIONS

TechLine 877 276-7876  
armstrongceilings.com/axiom

**Armstrong** 487B  
CEILING & WALL SOLUTIONS