

AXIOM® Direct Light Covers

DeclareSM
Living Building
Challenge Compliant

SUSTAINSM
High Performance
Sustainable
Ceiling Systems



50% ALUMINUM RECYCLED CONTENT

Calculate LEED contribution at
armstrongceilings.com/greengenie

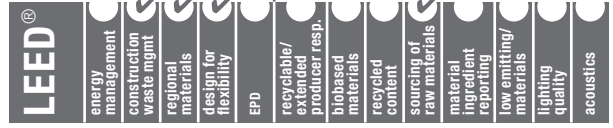

LOCATION DEPENDENT



KEY SELECTION ATTRIBUTES

Axiom extruded aluminum light covers offer ultra low plenum clearance, predictable lighting performance, and perfect integration with all Armstrong® suspension systems.

- Pre-engineered, extruded aluminum light cover profiles with integrated XAL LENO light fixture or Axis Click
- Axiom Direct Light Covers is part of the Sustain™ portfolio and meets the most stringent sustainability compliance standards today
- Fully concealed integrated design installs with all Armstrong® acoustical and drywall suspension systems
- Low profile design with plug and play lighting for easy installation in shallow plenum corridors and entry areas
- 10-Year Limited Warranty, 30-Year System Warranty

TYPICAL APPLICATIONS

- Offices
- Retail
- Hospitality
- Healthcare

LIGHTING FIXTURES

Compatible with:
Axis Lighting, i2Systems,
and XAL Leno Luminaire



VISUAL SELECTION

Item No.	Description	Dimensions (Inches)
AXIOM® Direct Light Covers		
□ AXDLC46	4 x 6" Direct Light Cover	120 x 4-1/2 x 6"
□ AXDLC44	4 x 4" Direct Light Cover	120 x 4-1/2 x 4"

Light Covers:
Aluminum extrusions formed with distinct architectural detail groove on bottom flange and special bosses to receive the T-Bar Connector Clip, Hanging Clip, and Splice Plate, to provide positive mechanical lock with no visible fasteners. Factory-finished to match approved samples.

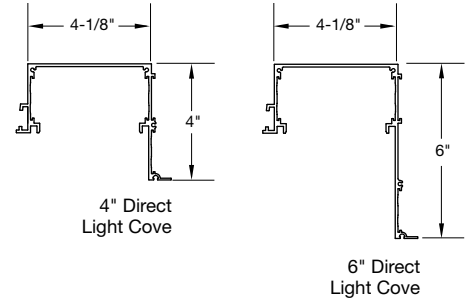

4" x 6" Direct Light Cover – AXDLC46

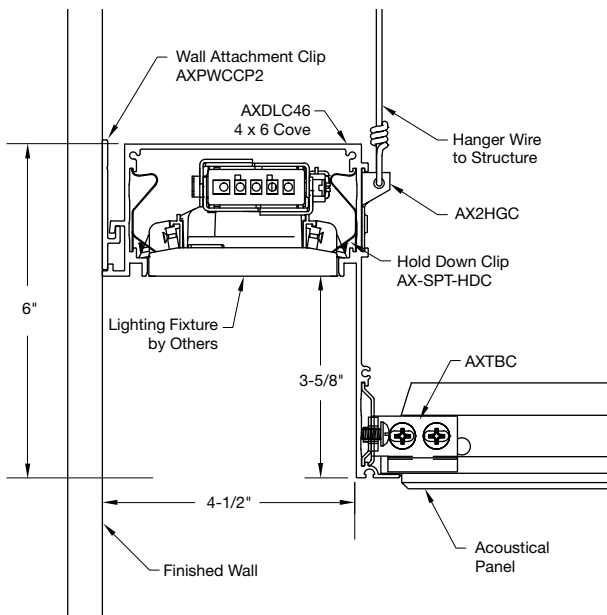

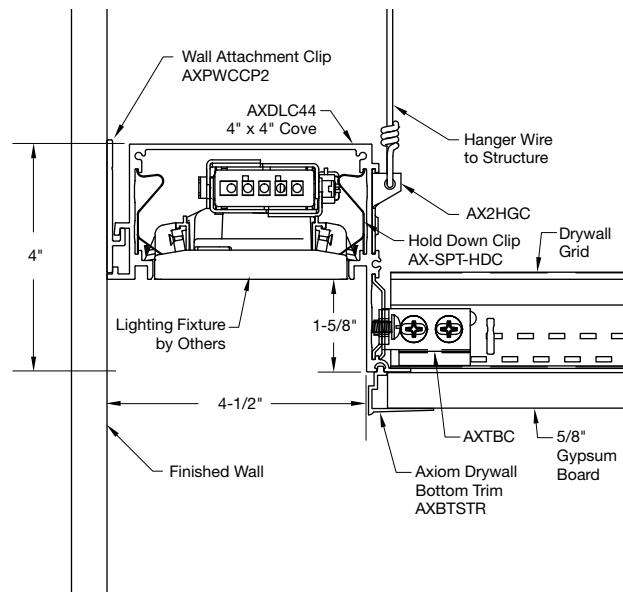

4" x 4" Direct Light Cover – AXDLC44

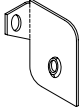
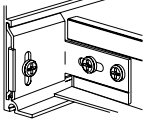
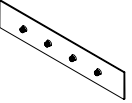
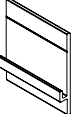
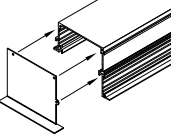

AXIOM® Direct Light Covers

VISUAL SELECTION

Item No.	Description	
Accessories		
<input type="checkbox"/> AXBTSTR	Axiom Bottom Drywall Trim Axiom Bottom Drywall Trim Straight for 5/8" Drywall. (Drywall sold separately)	
<input type="checkbox"/> AX2HGC	Hanging Clip Hanging Clip: Sheet steel formed to fit into special trim channel bosses and provide positive mechanical lock, screw-fastened connection to suspension members which intersect below the trim channel (included with material order).	
<input type="checkbox"/> AXTBC	T-Bar Connector Clip T-Bar Connector Clip: Galvanized sheet steel formed to fit into special trim channel bosses and provide positive mechanical lock with factory-installed screw, screw-fastened connection to suspension members which intersect the trim channel (included with material order).	
<input type="checkbox"/> AX4SPLICE	Axiom Splice Plate Splice Plate: Galvanized sheet steel formed to fit into the trim channel bosses and provide positive lock between abutting channels with factory-installed setscrews (included with material order).	
<input type="checkbox"/> AXPWCCP2	Axiom Wall Clip (included with material order) 2 x 2 x 1/2"	
<input type="checkbox"/> AXDLC46ECR	4 x 6" – Direct Light Cove End Cap – Right	
<input type="checkbox"/> AXDLC46ECL	4 x 6" – Direct Light Cove End Cap – Left	
<input type="checkbox"/> AXDLC44ECR	4 x 4" – Direct Light Cove End Cap – Right	
<input type="checkbox"/> AXDLC44ECL	4 x 4" – Direct Light Cove End Cap – Left	
<input type="checkbox"/> AX-SPT-HDC	Trim/Light Fixture Hold Down Clip	

AXIOM® Direct Light Covers

COMPATIBLE LIGHT FIXTURES

Axis Lighting

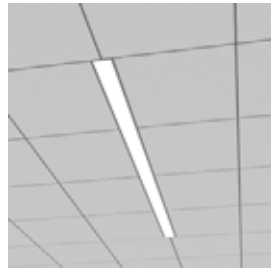
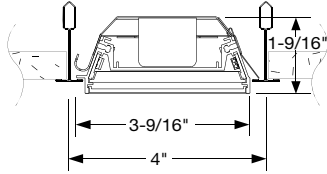

For more information: www.axislighting.com

Connect-Insert-Click – shallow linear system that installs from below:

- 1-3/4" shallow housing – same height as T-Bar
- Install and maintain from below with no need for access from above
- Can be installed after ceiling has been closed
- Ultra-thin lightguide technology delivering comfortable, uniform illumination along entire lens
- Seismic-tested and approved luminaire
- Hinged driver cover with full driver and wiring access



Compose™ by i2Systems

For more information: www.i2systems.com

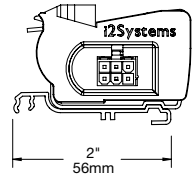

Same Output & Uniformity as Linear Sections

- Tight binning for uniformity
- 12", 18", and 48" lengths available to suit all configurations without gaps

High Performance, Indirect LED Lighting System

- Run 100+ fixtures from a single feed
- 1200+ lms/ft
- 2-12W/ft factory programmable

Plug & Play Mounting System

- Tool-free installation



XAL LENO Zero Plenum Luminaire

For more information: www.XALUSA.com

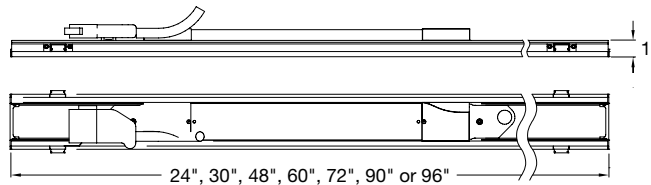
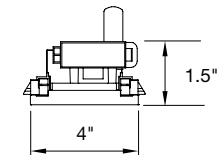

The new ultra thin XAL LENO Zero Plenum luminaire installs from below and features:

- High output, energy efficient LED lighting for any space
- High performance opal cover for uniform illumination and enhanced glare control
- Extruded aluminum fixture design
- White powder coated finish
- Integrated plug and play electrical connections
- Choice of light outputs to achieve any desired light level
- Dimming options available



PHYSICAL DATA

Material

Commercial quality extruded aluminum alloy 6063

Surface Finish

Factory-applied baked polyester paint finish

Warranty

10-Year Limited Warranty; 30-Year System Warranty

Profile

4" x 4" and 4" x 6" Light Cove with 3/4" horizontal flange

Cross Tee/Main Beam Interface

Flush Fit

End Detail

Splice with screws

ICC Reports

For areas under ICC jurisdiction, see evaluation report numbers ESR-1289 and ESR-1308 for allowable values and/or conditions of use concerning the suspension system components listed on this page. The reports are subject to reexamination, revisions, and possible cancellation.

TechLine / 1 877 276-7876
armstrongceilings.com/lightcovers
 BPCS-4984-1218

All product names are trademarks, registered trademarks, or service marks of their respective owners. All other trademarks used herein are the property of AWI Licensing LLC and/or its affiliates.
 © 2018 AWI Licensing LLC

