

Large Format Ceiling Panels

Installation Instructions

1. PRODUCT DESCRIPTION

This document covers the requirements when installing large format panels. It applies to large format mineral fiber and fiberglass panels installed in 9/16" or 15/16" suspension systems, with square lay-in or tegular edge details. Refer to product specific installation instructions for downward accessible products (i.e. Vector, Concealed).

2. DESIGN AND INSTALLATION CONSIDERATIONS

No special installation requirements are necessary for panels equal to or less than 5' in length. However, for installations of large panels, when grid layouts result in a length of grid greater than 5' without lateral support (i.e. cross tees), some additional considerations are necessary to ensure the integrity of the ceiling system.

3. ACCESSORIES

Armstrong Ceiling Solutions offers Stabilizer Clips that help maintain system stability while not limiting access as is typical when using stabilizer bars with lay-in products.

Stabilizer Clips are available for different panel thicknesses:

- 435 Stabilizer Clip for 3/4" to 1" thick panels

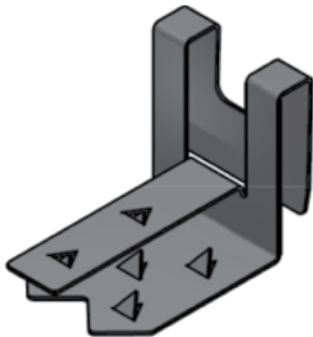

- 436 Stabilizer Clip for 1-1/2" to 1-3/4" thick panels

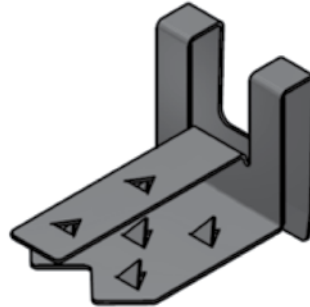

Stabilizer Clips are not supplied with the panels and must be ordered separately. These clips are packaged in cartons of 50.

4. SUSPENSION SYSTEM

4.1 General

Suspension systems, whether 9/16" or 15/16", shall be installed to meet the minimum requirements established in the ASTM C636 standard and any other requirements established by local code.

4.2 Load Carrying Requirements

All grid components used must be rated to carry the appropriate load per ASTM C635 and E3090. Consult the grid product data page for load carrying information.

Supplemental hanger wires on cross tees may be required for certain panel/layout combinations.

4.3 Plenum Space

2' wide panels require a minimum of 3" of clearance for installation. 4' wide panels require 8" of clearance.

5. PERIMETER TREATMENT

5.1 General

Perimeter panels, less than full size, shall be installed either by concealing the cut edge on the horizontal flange of a perimeter molding (option A), or by re-cutting the Tegular edge detail (option B).

5.1.1 Panel Face Resting on Molding (Option A)

For option A, when the face of the panel rests on the molding, Spring Border Clips (7870) should be used for proper panel alignment and to prevent the possibility of the panel shifting toward the wall far enough to permit the opposite edge to drop off of the grid flange.

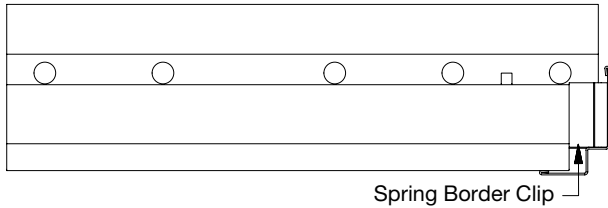

5.1.2 Re-cut the Edge Detail (Option B)

For option B, the suspension system rests directly on the horizontal flange of the molding. Tegular edges will have to be field-cut to allow the panel face to drop 1/4" below the grid. All field-cut edges "exposed to view" should be colored to match the factory finish. Armstrong SuperCoat Ceiling Panel Touch-up Paint is recommended.

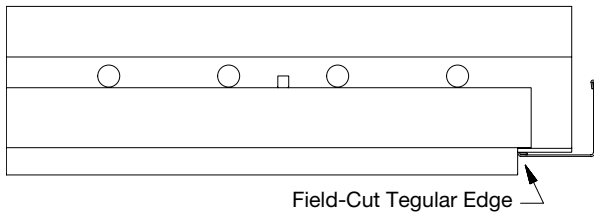

6. SPECIAL CONSIDERATIONS FOR LONG PANELS

6.1 General

During the installation process, or when a panel is removed from the grid for plenum access, a careless movement could cause the grid member to be bumped away from the adjacent panel. Under this condition, it is possible for that panel to fall from the ceiling plane.

6.2 Stabilizer Clips

Armstrong Ceiling Solutions recommends the use of Stabilizer Clips. These clips are embedded into the edges of the panels. The clips saddle over the suspension system, and prevent the grid from moving away from the panel edge.

6.2.1 Clip Guidelines

Stabilizer Clips are required when the length of grid between lateral supports (i.e. cross tee) is greater than 5'. When this condition occurs in the field of an installation the opposite side of the panel also requires a Stabilizer Clip regardless of the length of grid between lateral supports.

- Lengths of grid between lateral supports greater than 5' but less than 8' require one Stabilizer Clip at the midpoint

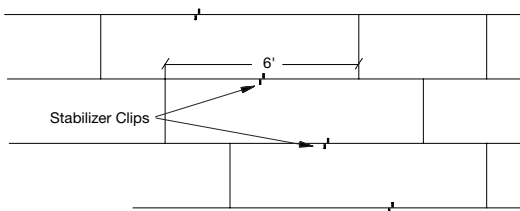

Length between lateral supports greater than 5' but less than 8'

- Lengths of grid between lateral supports 8' or greater require two Stabilizer Clips installed in the panel at one-third points

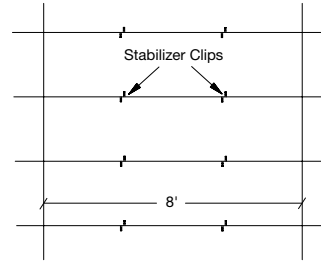

Length between lateral supports 8' or greater

6.2.2 Installing Stabilizer Clips

Clips may be installed either before or after the panel is raised above the grid system. The preferred installation method is to install the panel in the grid, and then raise the edge high enough to permit installation of the clips. If installing the clips prior to panel installation, place them where the hanger wires will not interfere with their function.

Clips are installed by resting the upper barbed flange on the back of the panel and pressing the two pointed flanges into the edge of the board until the clip is fully seated into the panel edge.

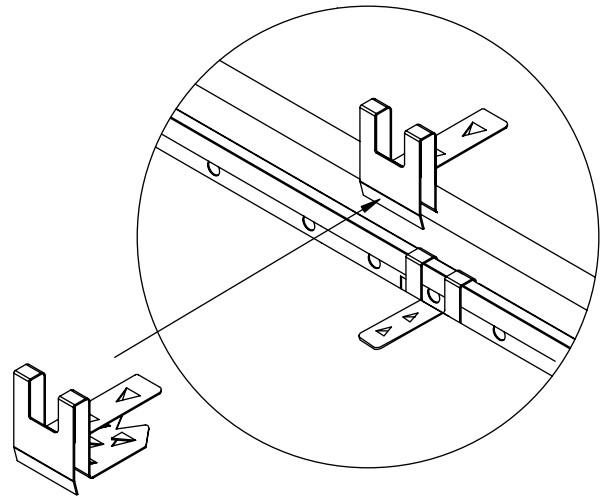

6.2.3 Panel Installation

Properly seat the panels. On occasion, the bottom of a clip may come down on top of the adjacent panel instead of slipping by the edge. When this occurs, raise both panels far enough to properly align the clips (about 1") and lower them together onto the grid flange.

7. SEISMIC CONSIDERATIONS

The requirements listed in this document apply to all installations regardless of Seismic Design Category.

MORE INFORMATION

For more information, or for an Armstrong Ceilings representative, call 1 877 276 7876.

For complete technical information, detail drawings, CAD design assistance, installation information, and many other technical services, call TechLine customer support at 1 877 276 7876 or FAX 1 800 572 TECH.

For the latest product selection and specification data, visit armstrongceilings.com/commercial.

Inspiring Great Spaces® is a registered trademark of AFI Licensing LLC.

All other trademarks used herein are the property of AWI Licensing LLC and/or its affiliates.

© 2018 AWI Licensing LLC • Printed in the United States of America

BPLA-295690-1018

