

AXIOM[®]

Building
Perimeter
System

Lutron Compatible
Shade Pockets



Inspiring Great Spaces[®]



Integrated SHADE POCKETS

Now, there's a new integrated pocket and shading solution for building perimeter systems, thanks to a collaboration between Armstrong World Industries and Lutron. This pre-engineered solution provides superior aesthetics, performance, and the most advanced shading solution on the market today.

WHY CONSIDER THIS SOLUTION?

ARCHITECTS:

- ▶ Easy to specify – pre-engineered pocket and shade solution
- ▶ Provides seamless integration to acoustical or drywall ceilings
- ▶ Industry-leading aesthetics
- ▶ Best in class performance
- ▶ Seismic code compliant

CONTRACTORS:

- ▶ Reduces risk and eliminates guesswork
- ▶ Installs as part of a complete ceiling solution
- ▶ Faster system installation gets you on and off the job quicker
- ▶ Integrated sub-brackets make shade installation easier
- ▶ Lower cost of installation

Seamless Integration





Also available for drywall installations

ARMSTRONG® CEILING POCKETS

Lutron Compatible Shade Pockets:

- Install 12 times faster than drywall pockets and twice as fast as traditional pockets
- Integrate with drywall and acoustical suspension systems like no other pocket can for perfect fit and finish
- Engineered specifically for Lutron Contract Roller and Sivoia® QS Roller

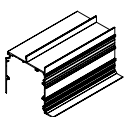
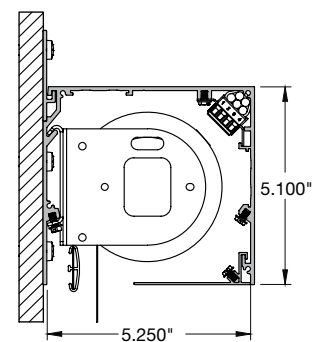
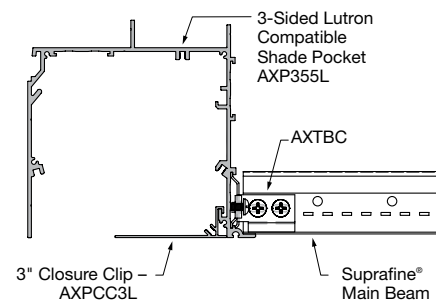

AXP355L

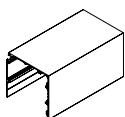

AXP355LE

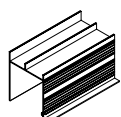

AXP355D

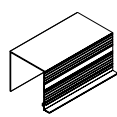

AXP355MD

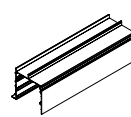

AXP355LD

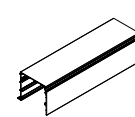

AXP355LMLA

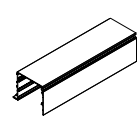

AXP355LMLD

LUTRON® Shading Solutions

Lutron has been the leading provider of motorized shades for over 20 years with automated installations in the most recognized commercial buildings around the world.





In both new construction and renovation projects, Lutron commercial shades deliver world-class daylight control solutions that upgrade the value of any commercial space, improve the performance of buildings and people, and enhance the design of a project from the exterior to the interior.

Lutron's Performance Fabric Collection offers 300+ high-performance and sustainable solar screen and blackout fabric options.

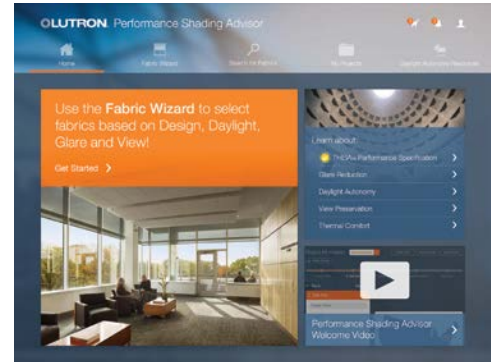
Start with the Right Fabric PerformanceShadingAdvisor.com

- Get fabric recommendations for your project
- Browse all 400+ fabrics and order free samples
- Select the right shade pocket
- Download product specifications and drawings
- Explore control options & keypad finishes



-  Spec Grade Solar Screens (THEIA™ Compliant Fabrics)
-  General Purpose Solar Screens
-  Sustainable Solar Screens
-  Blackouts





For standard commercial applications, choose Lutron’s Contract Roller with any Performance fabric. These commercial grade shading solutions ensure design consistency throughout your building and feature Lutron’s superior quality, service, and delivery.

Motorized Roller Shades

- Can move up to 6 Inhne shades (approx. 300 square feet) with a single low voltage drive
- Low voltage power and communication
- Lutron shades align with each other at all times to within 1/8" at start, stop, and in motion
- Integrates seamlessly with Lutron lighting control
- Available as a stand-alone solution or part of a fully automated environmentally responsive system.

Manual Roller Shades

- Width: 13.5 in (0.34 m) Min, 10 ft (3.05 m) Max.
- Height: 12 in (0.30 m) Min, 15 ft (4.57 m) Max.
- Available with the options to match Lutron motorized shades
- Durable clutch components and aluminum tubes

Pocket Options:

- Single pocket
- Dual pocket

Single and dual fascia also available to integrate with Contract Roller

For more info, visit: Lutron.com/contractroller

Specify this High Performance Solution (Division 12, Cross Reference Division 9)

- Quantum with Hyperion Solar Adaptive Shading System
- Radio Window Sensor
- Contract Roller QS motorized shades
- Lutron Compatible Shade Pocket by Armstrong





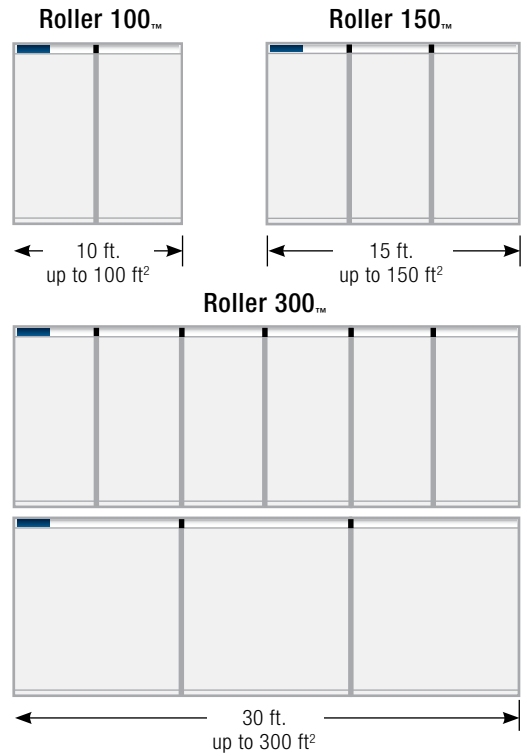





For existing Lutron shades, the Axiom pocket also integrates with Lutron’s Sivoia QS and QS Wireless roller shades.

Compatible Roller Shades



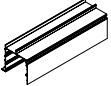









The Perfect Solution for Your Ceiling Design

Lutron Compatible Shade Pockets

Item Number	Description	Dimensions (Inches)	Length	
MOTORIZED SHADE POCKETS – For attachment with 2-1/2" studs				
Acoustical Flange Shade Pocket and End Caps				
<input type="checkbox"/> AXP355L	3-Sided Lutron Compatible Shade Pocket with Acoustical Flange	5 x 5 x 5"	120"	
<input type="checkbox"/> AXP355LECR	Lutron End Cap – Right	5 x 5"		
<input type="checkbox"/> AXP355LECL	Lutron End Cap – Left	5 x 5"		
Seismic Flange Shade Pocket and End Caps				
<input type="checkbox"/> AXP355LS	3-Sided Lutron Compatible Shade Pocket with Seismic Flange	5 x 5 x 5"	120"	
<input type="checkbox"/> AXP355LSECR	Lutron Seismic End Cap – Right	5 x 5"		
<input type="checkbox"/> AXP355LSECL	Lutron Seismic End Cap – Left	5 x 5"		
Drywall Flange Shade Pockets				
<input type="checkbox"/> AXP355LD	3-Sided Lutron Compatible Shade Pocket with Drywall Flange	5 x 5 x 5"	120"	
<input type="checkbox"/> AXP355LDIC	3-Sided Lutron Compatible Shade Pocket with Drywall Flange – Inside Corner	5 x 5"	12"	
<input type="checkbox"/> AXP355LDOC	3-Sided Lutron Compatible Shade Pocket with Drywall Flange – Outside Corner	5 x 5"	12"	
Connection Perimeter Pockets and Connection Accessories				
<input type="checkbox"/> AXP355LC	3-Sided Lutron Compatible Shade Pocket with Connection to Extension/Face Plate Piece	5 x 5 x 5"	120"	
<input type="checkbox"/> AXP355LEEC	Lutron for AXP355LE and AXP355LC End Cap	5 x 5"	120"	

AXIOM® Building Perimeter System

Lutron® Compatible Shade Pockets

Item Number	Description	Dimensions (Inches)	Length	
MOTORIZED SHADE POCKETS – For Traditional Framing				
Exposed Shade Pocket and End Caps				
<input type="checkbox"/> AXP355LE	3-Sided Exposed Lutron Compatible Shade Pocket	5 x 5 x 5"	120"	
<input type="checkbox"/> AXP355LE__*	3-Sided Exposed Lutron Compatible Shade Pocket, colors	5 x 5 x 5"	120"	
<input type="checkbox"/> AXP355LEEC	Lutron for AXP355LE and AXP355LC End Cap	5 x 5"		
<input type="checkbox"/> AXP355LEEC__*	Lutron Exposed End Cap, colors	5 x 5"		
Acoustical Flange Shade Pockets and Corners				
<input type="checkbox"/> AXP355MLA	3-Sided Lutron Compatible Shade Pocket with Acoustical Flange	5 x 5 x 5"	120"	
<input type="checkbox"/> AXP355MLAIC	3-Sided Lutron Compatible Shade Pocket with Acoustical Flange – Inside Corner	5 x 5"	12"	
<input type="checkbox"/> AXP355MLAOC	3-Sided Lutron Compatible Shade Pocket with Acoustical Flange – Outside Corner	5 x 5"	12"	
Drywall Flange Shade Pockets and Corners				
<input type="checkbox"/> AXP355MLD	3-Sided Lutron Compatible Shade Pocket with Drywall Flange	5 x 5 x 5"	120"	
<input type="checkbox"/> AXP355MLDIC	3-Sided Lutron Compatible Shade Pocket with Drywall Flange – Inside Corner	5 x 5"	12"	
<input type="checkbox"/> AXP355MLDOC	3-Sided Lutron Compatible Shade Pocket with Drywall Flange – Outside Corner	5 x 5"	12"	

Motorized Shade Pocket – For Attachment with 2-1/2" Studs

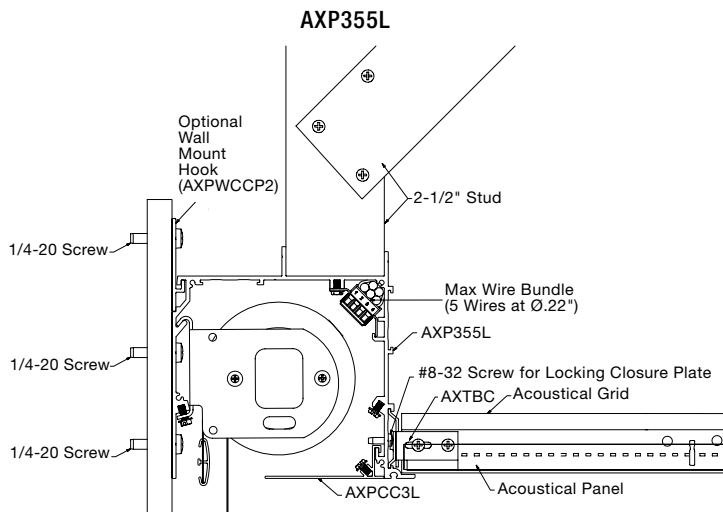



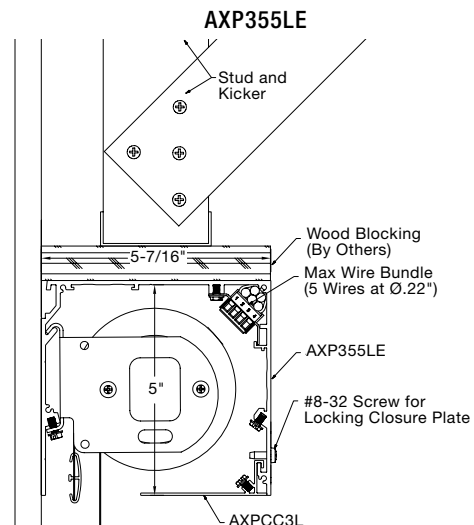









Motorized Shade Pocket – For Traditional Framing



AXIOM® Building Perimeter System

Lutron® Compatible Shade Pockets

Item Number	Description	Dimensions (Inches)	Length	
MANUAL SHADE POCKETS – For attachment with 2-1/2" studs				
Drywall Flange Shade Pocket and End Cap				
<input type="checkbox"/> AXP355D	3-Sided Shade Pocket with Drywall Flange	5 x 5 x 5"	120"	
<input type="checkbox"/> AXP355DISC	3-Sided Shade Pocket with Drywall Flange – Inside Corner	12 x 5 x 12"	12"	
<input type="checkbox"/> AXP355DOSC	3-Sided Shade Pocket with Drywall Flange – Outside Corner	12 x 5 x 12"	12"	
<input type="checkbox"/> AXP355DEC	3-Sided End Cap for Drywall Flange Pocket	5 x 5"		
MANUAL SHADE POCKETS – For Traditional Framing				
Acoustical Flange Pockets and Corners				
<input type="checkbox"/> AXP355MA	Perimeter Pocket with Acoustical Flange	5 x 5 x 5"	120"	
<input type="checkbox"/> AXP355MAOSC	Perimeter Pocket with Acoustical Flange – Outside Corner	12 x 5 x 12"	12"	
<input type="checkbox"/> AXP355MAISC	Perimeter Pocket with Acoustical Flange – Inside Corner	12 x 5 x 12"	12"	
Drywall Flange Pockets and Corners				
<input type="checkbox"/> AXP355MD	Perimeter Pocket with Drywall Flange	5 x 5 x 5"	120"	
<input type="checkbox"/> AXP355MDOSC	Perimeter Pocket with Drywall Flange – Outside Corner	12 x 5 x 12"	12"	
<input type="checkbox"/> AXP355MDISC	Perimeter Pocket with Drywall Flange – Inside Corner	12 x 5 x 12"	12"	
Exposed Pockets and Corners (custom colors available)				
<input type="checkbox"/> AXP355ME	Exposed Application Perimeter Pocket	5 x 5 x 5"	120"	
<input type="checkbox"/> AXP355MEOSC	Exposed Application Perimeter Pocket – Outside Corner	12 x 5 x 12"	12"	
<input type="checkbox"/> AXP355MEISC	Exposed Application Perimeter Pocket – Inside Corner	12 x 5 x 12"	12"	

AXIOM® Building Perimeter System

Lutron® Compatible Shade Pockets

Item Number	Description	Dimensions (Inches)	Length
MANUAL SHADE POCKETS (cont'd) – For Traditional Framing			
End Cap			
□ AXP355MS	Perimeter Pocket with Seismic (0.875") Flange	5 x 5 x 5"	120"
□ AXP355MSOSC	Perimeter Pocket with Seismic (0.875") Flange – Outside Corner	12 x 5 x 12"	12"
□ AXP355MSISC	Perimeter Pocket with Seismic (0.875") Flange – Inside Corner	12 x 5 x 12"	12"
End Cap			
□ AXP355MEC	Perimeter Pocket End Cap for Traditional Framing Pockets (AXP355MA, AXP355MD, AXP355ME, AXP355MS)	5 x 5"	

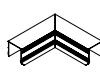
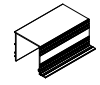

Manual Shade Pocket – For Attachment with 2-1/2" Studs

AXP355D

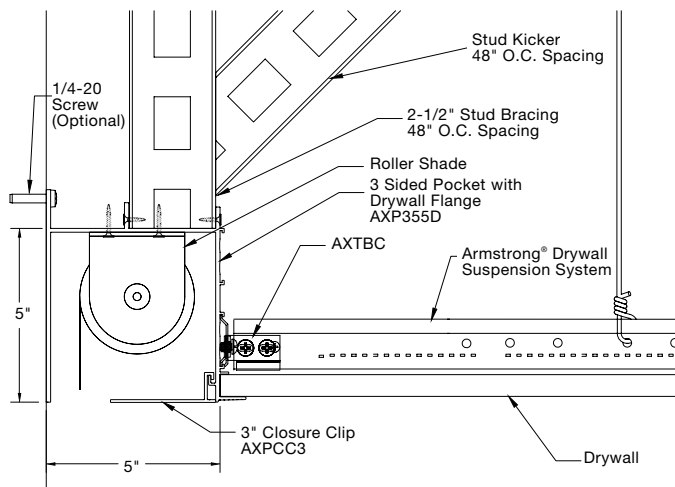





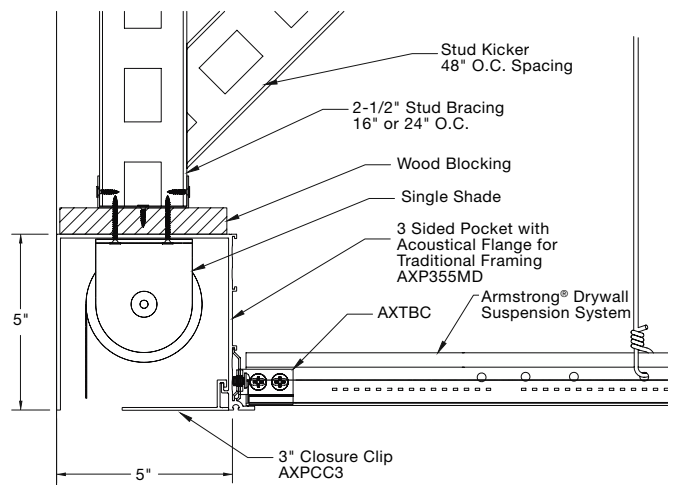

Manual Shade Pocket – For Traditional Framing

AXP355MD

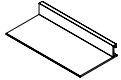
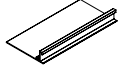

AXIOM® Building Perimeter System

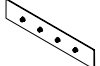
Lutron® Compatible Shade Pockets

Item Number	Description	Dimensions (Inches)	Length	
ACCESSORIES				
Closure Clip				
<input type="checkbox"/> AXPCC3	3" Shade Closure Clip for Manual Shade Pocket	3"	120"	
<input type="checkbox"/> AXPCC3L	3" Shade Closure Clip	3"	120"	
<input type="checkbox"/> AXPCC3L__*	3" Shade Closure Clip, colors	3"	120"	
Installation Accessories				
<input type="checkbox"/> AXPWCCP2	Axiom Wall Clip with Hook for Closure Clip Attachment	2 x 1/2"	2"	
<input type="checkbox"/> BERCAXT	Axiom Beam End Retaining Clip for Seismic Applications	—	—	
<input type="checkbox"/> AXTBC	Axiom T-Bar Connector Clip			
<input type="checkbox"/> AX4SPLICE	Axiom Splice Plate with Setscrews Provides positive lock between abutting pockets		8"	
<input type="checkbox"/> AXPSPLINE	Axiom Building Perimeter Interlocking Spline for connection between perimeter pocket and extension or face plate piece	—	120"	

* Add the 2-letter color suffix to the item number when specifying or ordering (Example: AXP355LE **B** **L**, 3-Sided Exposed Lutron Compatible Shade Pocket in Black)

TAKE THE NEXT STEP

1 877 276 7876

Customer Service Representatives
7:45 a.m. to 5:00 p.m. EST
Monday through Friday

TechLine – Technical information, detail drawings, CAD design assistance, installation information, other technical services – 8:00 a.m. to 5:30 p.m. EST, Monday through Friday. FAX 1 800 572 8324 or email: techline@armstrongceilings.com

armstrongceilings.com/commercial

Latest product news
Standard and custom product information
Online catalog
CAD, Revit®, SketchUp® files
A Ceiling for Every Space® Visual Selection Tool
Product literature and samples – express service or regular delivery
Contacts – reps, where to buy, who will install

YOU INSPIRE™ SOLUTIONS CENTER

1 800 988 2585
email: solutionscenter@armstrongceilings.com
armstrongceilings.com/youinspire

Design Assistance

Collaborative design
Detail drawings
Specifications
Planning and budgeting

Pre-construction Assistance

Layout drawings for standard and premium products
Project installation recommendations
Contractor installation assistance

you inspire™
solutions center

helping to bring your one-of-a-kind ideas to life

Lutron Shading Customer Service

Phone: 1-800-446-1503
Email: shadingcustsvc@lutron.com
www.performanceshadingadvisor.com

 **LUTRON**®
Shading Solutions

Inspiring Great Spaces® is a registered trademark of AFI Licensing LLC;
Lutron®, THEIA™, Quantum®, Hyperion™, Radio Window™, Sivoia®, roller 100™, roller 150™, and roller 300™ are trademarks of Lutron Electronics Co., Inc.; Revit® is a registered trademark of Autodesk, Inc.; SketchUp™ is a trademark of Trimble Inc.
All other trademarks used herein are the property of AWI Licensing Company and/or its affiliates
© 2018 AWI Licensing Company • Printed in the United States of America

armstrongceilings.com/lutron

Inspiring Great Spaces®

 **Armstrong**®
CEILING SOLUTIONS