

TECTUM® Lay-in and Tegular Ceiling Panels

Assembly and Installation Instructions for 1-Inch Thick Standard Lay-in and Tegular Ceiling Panels

TECTUM® LAY-IN & TEGULAR CEILING PANELS – STANDARD ITEMS:				
Item No. ♦	Item Name	Included with panels	Sold by the:	SF per Ctn
8184T10_ _ _	24" x 24" x 1" Lay-in Panel	-	Carton	32
8183T10_ _ _	24" x 48" x 1" Lay-in Panel	-	Carton	32
8186T10_ _ _	24" x 24" x 1" Tegular Panel	-	Carton	32
8185T10_ _ _	24" x 48" x 1" Tegular Panel	-	Carton	32
TECTUM CEILING PANELS – SUSPENSION SYSTEM AND ACCESSORIES				
Item No.	Item Name	Included with panels	Sold by the:	Pcs per Ctn
7300	Prelude® XL® 15/16" ID Main Beam	No	Carton	240 LF
XL7328	Prelude XL 15/16" 2' Cross Tee	No	Carton	240 LF
XL7340	Prelude XL 15/16" 4' Cross Tee	No	Carton	240 LF
7800	12" Wall Angle Molding (for Lay-in)	No	Carton	360 LF
7875	10' Shadow Molding (for Tegular)	No	Carton	300 LF
7301*	Prelude XL 15/16" HD Main Beam	No	Carton	240 LF
XL8320*	Prelude XL 15/16" 2' Cross Tee	No	Carton	240 LF
XL7341*	Prelude XL 15/16" 4' Cross Tee	No	Carton	240 LF
7897*	10' Shadow Molding (for Tegular Seismic Installation)	No	Carton	300 LF
BERC2*	2" Beam End Retaining Clip (for Seismic Installation)	No	Carton	200 pieces
8178T10*	TECTUM® Hold-Down Clip <i>(for use with 1" thick Lay-in panels only)</i>	No	Carton	200 pieces
1713*	School Zone® Fine Fissured™ Infill Panel	No	Carton	48 SF

♦ When specifying or ordering, include the appropriate 3-digit color suffix TNA = Natural TWH = White (e.g. 8186T10 IWH) For special sizes and colors, call TechLine at 1 877 276 7876.
* For Seismic, High Impact, and Total Acoustics Performance installations, see Sections 9 and 4.3.

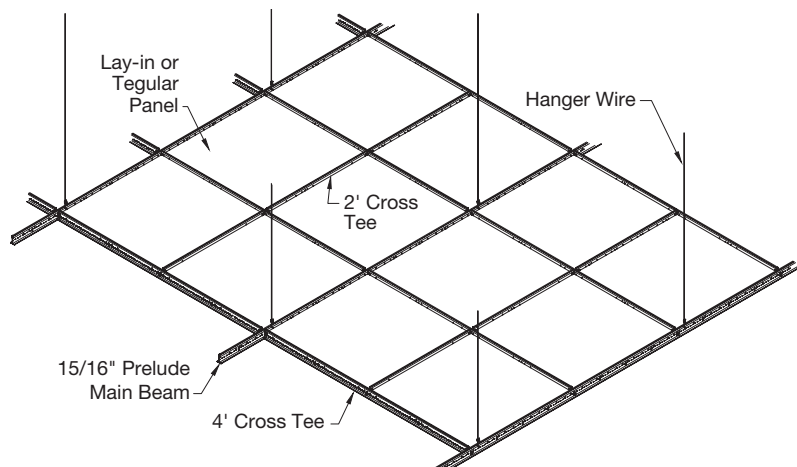

1. GENERAL

1.1 Product Description

TECTUM® panels are highly durable panels made of Aspen wood fibers held together with a cementitious binder. Standard TECTUM Lay-in and Tegular ceiling panels are 1" thick and available in nominal sizes of 2 x 2' and 2 x 4'. Actual size is 23-3/4" x 23-3/4" or 23-3/4" x 47-3/4". Due to the natural characteristics of the wood fibers, slight dimensional differences may cause Tegular panels to appear to vary in size. Lay-in panels have a square edge on all four sides. Tegular panels have a stepped edge, with the face of the panel dropping a nominal 1/2" below the face of the grid. Panels are available in two colors: painted white or natural finish. Please note, both white and natural panels will show normal color variation due to the wood fibers. Panels can be field cut and field painted up to six times without impacting acoustic or fire performance.

1" TECTUM Lay-in and Tegular panels offer sound absorption or NRC of 0.40. In areas that require higher levels of acoustical performance, the SCHOOL ZONE® Fine Fissured™ panel (Item 1713) can be installed behind the TECTUM Tegular panel to provide Total Acoustics® Performance, NRC of 0.90 and CAC of 35. Lay-in panels achieve NRC of 0.90 and CAC of 33 when installed with SCHOOL ZONE Fine Fissured panel (Item 1713).

2 x 4' TECTUM Lay-in and Tegular panels are installed using Prelude® XL® Intermediate Duty Main Beam (Item 7300), 4' cross tees (Item XL7340). 2 x 2' panels will also require 2' cross tees (Item XL7328). Lay-in panels will use wall angle molding (Item 7800). For Tegular installations, shadow molding (Item 7875) is recommended. For seismic and high-impact installations, as well as for installations with acoustic infill panels, see Sections 4 and 9 for alternative suspension system guidance.

1.2 Safety

This product is made of wood fibers and cementitious binder. Sawing, sanding, or machining these products can produce wood dust and crystalline silica. Airborne dust can cause respiratory, eye and skin irritation. Respirable wood dust and crystalline silica are classified as carcinogens. Personal protective equipment includes safety glasses or goggles, and impervious gloves. Respiratory protection may be required and depends on how the product is being cut and handled. Job site environmental conditions must be evaluated in determining what type of respiratory protection is required. In all cases, cutting is to be performed in a well ventilated area and power tools must be equipped with a dust collection system. Refer to the Safety Data Sheet www.armstrongceilings.com/TECTUM for additional information.

1.3 Warranty

Failure to follow Armstrong Ceilings recommended installation instructions in effect at the time of installation may void the product and/or ceiling system warranty.

1.4 Surface Finish

TECTUM panels are made of wood fibers within a cementitious binder. White panels are finished with a latex-based paint. Due to the unique porous composition of TECTUM panels, they can be field painted up to six times without impacting acoustic or fire performance.

NOTE: The edges of TECTUM panels are not fully painted. For installations where finished painted edges are required, see Section 4.5 for field painting guidance.

1.5 Storage & Handling

Panels should be stored in a dry interior location and shall remain in cartons prior to installation to avoid damage. The cartons should be stored in a flat, horizontal position.

Proper care must be taken when handling to avoid damage and soiling. Do not store in unconditioned spaces with humidity greater than 85% or lower than 25% RH and temperatures lower than 32°F or greater than 120°F. Panels must not be exposed to extreme temperatures, for example, close to a heating source or near a window where there is direct sunlight.

1.6 Site Conditions

TECTUM panels are required to reach room temperature and have stabilized moisture content for a minimum of 72 hours before installation. They should not, however, be installed in spaces where the temperature is lower than 32°F or greater than 120°F or humidity conditions are greater than 85% or lower than 25% RH. Panels must not be exposed to extreme temperatures, for example, close to a heating source or near a window where there is direct sunlight. All wet work (plastering, concrete, etc.) must be complete and dry.

1.7 HVAC Design & Operation, Temperature & Humidity Control

Real wood and wood composite products are natural building materials and they will react to changes in humidity. Spaces with installed product should be maintained with humidity in a range between 25% and 85% RH and temperatures in a range between 32°F and 120°F (Wood tends to contract with lower humidity and expand with higher humidity.) Cementitious wood fiber panels may also have a tendency to warp, twist, or bow, due to the natural stresses in the components and these humidity changes. Be aware of these natural tendencies when evaluating the products. It is also necessary for the area to be enclosed and for the HVAC systems to be functioning and in continuous operations for the life of the product. All wet work (plastering, concrete, etc.) must be complete and dry. Standard 1" TECTUM panels cannot be used in exterior applications. Contact TechLine for information on custom TECTUM products available for exterior installations.

1.8 Colors

Standard TECTUM panels are available in Natural and White finishes. Due to the natural variation of TECTUM wood fibers, Natural and White panels will have normal color variation from panel-to-panel and within panels. See Section 4.5 for field painting guidelines. Factory-finished custom colors are also available (contact TechLine).

2. DESIGN CONSIDERATIONS

2.1 Directionality

TECTUM® Lay-in and Tegular ceiling panels have a surface comprised of random wood fibers and therefore will not have installation considerations related to directionality of panels.

2.2 Edges

Lay-in Panels have four square edges which are not factory painted. Visible Tegular edges are not factory painted, if project requires painted Tegular edges, see Section 4.5 for guidance on field painting.

2.3 Pool installations

1" TECTUM ceiling panels are not to be used in pool or other high humidity areas where standing water is present. Contact TechLine for information on custom TECTUM products available for pool installations.

2.4 Exterior installations

1" TECTUM ceiling panels are not intended for exterior use. Contact TechLine for information on exterior installation.

2.5 Accessibility

In standard installations of TECTUM Lay-in and Tegular ceiling panels, accessibility to the plenum above the panels will be maintained. Please note, use of TECTUM Hold-Down Clips in high impact applications will minimize accessibility.

2.6 Plenum Clearance

Panels will be tilted into the grid opening and dropped into place, requiring 3" of height above the face of the grid.

3: TECTUM® LAY-IN AND TEGULAR CEILING PANEL ACCESSORIES

3.1 TECTUM Hold-Down Clips

TECTUM Hold Down Clips (Item 8178T10) are sold 200 pieces per carton. This dual-sided clip fits over the main runner or cross tee, engaging with the bulb of the grid to hold Lay-in panels in place in high impact areas, where forces may otherwise dislocate the panel. Note, use of this clip will slightly minimize accessibility behind the panels, as additional force will be required to lift the panel from the grid.

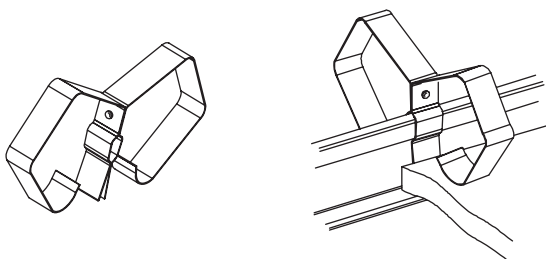

TECTUM Hold-Down Clip 8178T10

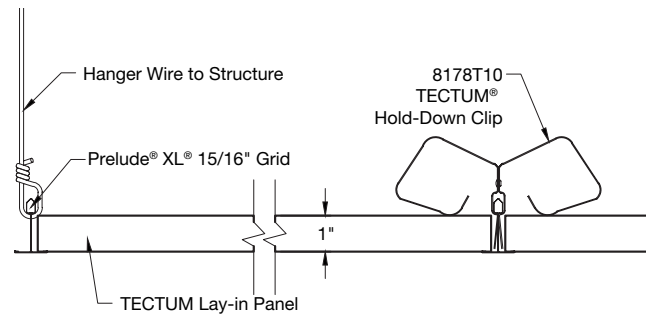

4: SUSPENSION SYSTEM FOR LAY-IN & TEGULAR TECTUM CEILING PANELS (WALL-TO-WALL)

4.1 Standard Suspension System

The requirements listed here represent the manufacturer's minimum acceptable installation recommendations, and may be subject to additional requirements established by the local authority having jurisdiction.

- All installations shall follow ASTM C636.
- All references to suspension component duty ratings are per ASTM C635

Main beams (Item 7300) will be installed 48" O.C., with 4' cross tees (Item XL7340) perpendicular to the main beams at 24" O.C.. For 2 x 2' panel installation, 2' cross tees (Item XL7328) will span the midpoints of the 4' cross tees.

For perimeter molding of Lay-in panels use standard (Item 7800) wall angle molding.

For perimeter molding of the Tegular panels, use the shadow molding (Item 7875) to ensure the correct drop to be flush with the face of the Tegular panels. Alternatively, the grid system can be raised 1/4" and having the tile rest on (Item 7800) 7/8" molding for non-seismic areas. NOTE: Using (Item 7800) with Tegular panels will result in a "mouse-hole" at the molding.

For Seismic considerations, see Section 9.

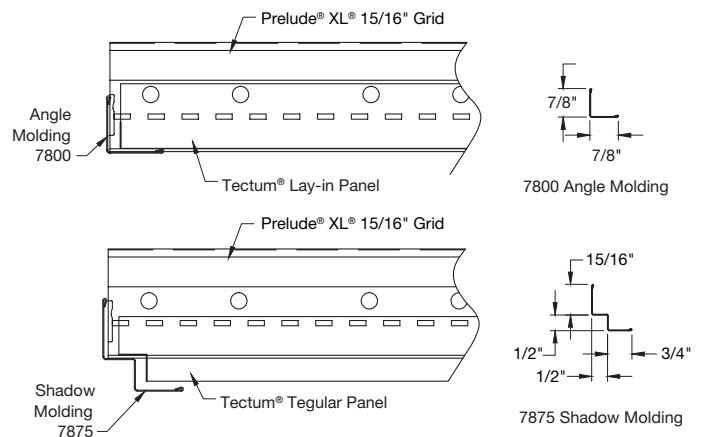

Section 4.2 High-Impact/High-Abuse Suspension System

Highly durable Lay-in panels can be used in high-impact or high-abuse areas such as gymnasiums or dormitories where outside forces can impact panels. 2 x 2' or 2 x 4' Lay-in panels will be installed in Prelude® XL® Heavy Duty system along with TECTUM® Hold-Down Clip (Item 8178T10).

Prelude Heavy Duty Main beams (Item 7301) will be installed 48" O.C., with 4' cross tees (Item XL7341) perpendicular to the main beams at 24" O.C.. For 2 x 2' panel installation, 2' cross tees (Item XL8320) will span the midpoints of the 4' cross tees.

Before the panels are installed into grid, TECTUM Hold Down Clips will be installed with two clips per 2 x 2' panel or four clips per 2 x 4' panel as shown in the following diagram.

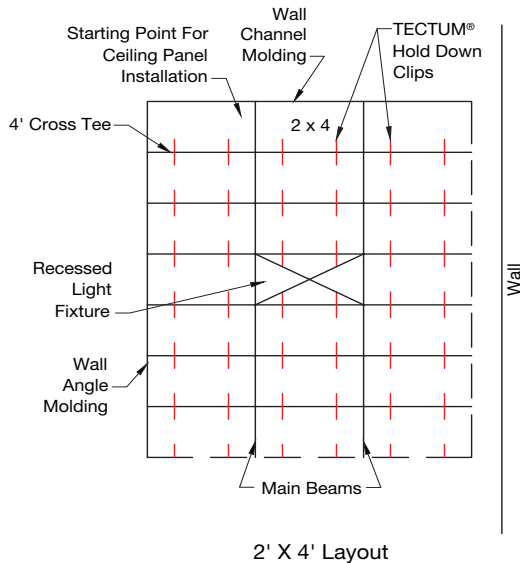

2' X 4' Layout

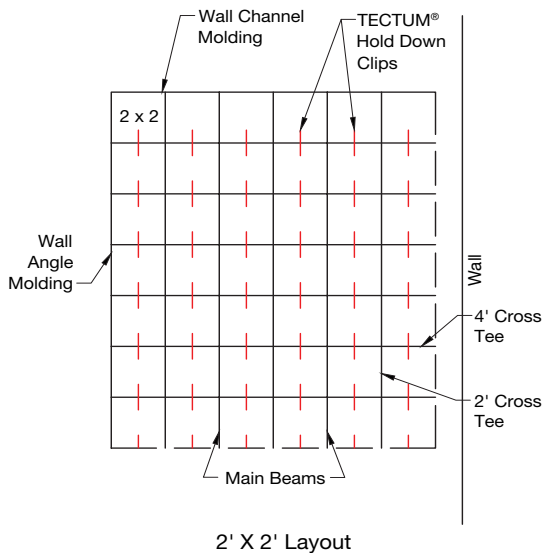

2' X 2' Layout

5: PANELS

5.1 Edge Detail/Interface

Lay-in panels have four square edges. Tegular panels have a stepped edge in which the face of the panel drops 1/2" below the face of the grid. **NOTE:** Exposed edges of panels are not factory painted. This will be visually apparent on Tegular panels upon installation. See Section 5.4 for guidance on field painting.

TECTUM Lay-in and Tegular ceiling panels install just like traditional acoustical ceiling panels. Lay-in panels are supported on the flange of the grid. The Tegular panels are supported on the flange, with the face of the panel falling 1/2" below the grid face.

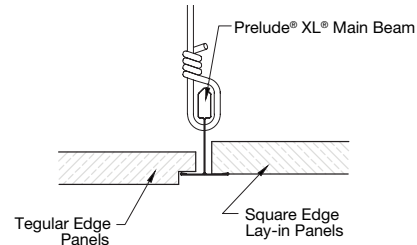

5.2 Cutting TECTUM Ceiling Panels

Cut the panel using standard woodworking tools and techniques. A table saw is recommended for straight cuts and a band saw for curved cuts. In both cases, panels should be cut face up to minimize chipping of the face veneer. To replicate the Tegular edge, a hand router that can cut 90 degree angles. Fine-toothed blades recommended for finish cuts will yield the best results.

5.3 Installing TECTUM Panels with Acoustical Infill Panels

Lay the acoustic panel (SCHOOL ZONE® Fine Fissured™, Item 1713, recommended) on the back surface of the Lay-in or Tegular panel and install together. Alternatively, lay the infill panels on the back of already installed panels as you progress across the space.

NOTE: TECTUM ceiling panels installed with acoustic infill panels should be installed following DEF guidelines due to the total system weight.

See seismic installation Section 9 for details.

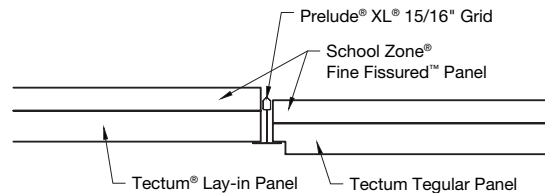

5.4 Field Painting TECTUM Ceiling Panels

TECTUM Lay-in and Tegular ceiling panels can be field painted up to six times to achieve the desired color and aesthetic without impacting acoustic or fire performance. Panels should be removed from the suspension system prior to painting and be allowed to fully dry before being returned to the grid. Adhere to the following painting guidelines for best results. In addition, minor touch up or edge painting can be applied with a brush or roller.

Field Painting Specification Recommendation:

Sherwin-Williams® Product: Waterborne Acrylic Dry Fall (B42W1) 50 GAL. Drums MPI# 118 (or substitute Alkali based, flat latex paints with similar properties)

Tests have shown that six coats of spray-applied paint have no negative impact on the acoustical and fire properties of the TECTUM® panels.

Recommended Spread Rate per Coat

Wet Mil: 3.5 - 5.0

Dry Mil: 1.5 - 2.0

Coverage: 336-450 sq. ft./gallon approximate (based on flat surface)

If necessary, cross spray at a right angle.

Surface Preparation

Surface must be clean, dry, and in sound condition. Remove all oil, dirt, grease, and other foreign material to ensure adequate adhesion.

Application Condition

Temperature: 50 deg. F minimum, 110 deg. F maximum (air, surface, and material) ; At least 5 deg. F above dew point

Relative Humidity: 75% maximum

Dry Time: 20 minutes

Recoat: 1 hour *

During the early stages of drying, the coating is sensitive to rain, dew, high humidity, and moisture condensation. Plan painting schedules to avoid these influences during the first 16-24 hours of curing.

Dryfall characteristics will be adversely affected at temperatures below 77 deg. F or above 50% relative humidity.

Application Equipment

The following is a guide. Changes in pressure and tip sizes may be needed for proper spray characteristics.

Airless Spray:

Pressure: 2800

Hose: 1/4" ID

Tip: 0.013"

Reduction: As needed up to 10% by volume.

Conventional Spray:

Gun: Binks 95

Fluid Nozzle: 63C

Air Nozzle: 63PB

Atomization Pressure: 60 psi

Fluid Pressure: 50 psi

Reduction: As needed up to 20% by volume

Brush and Roller:

Not recommended for the face of the product

SECTION 6: DISCONTINUOUS/FLOATING INSTALLATION

6.1 Clouds with Axiom® Trim

TECTUM Lay-in and Tegular ceiling panels can be installed as a discontinuous system using Prelude® suspension system and Axiom® trim solutions.

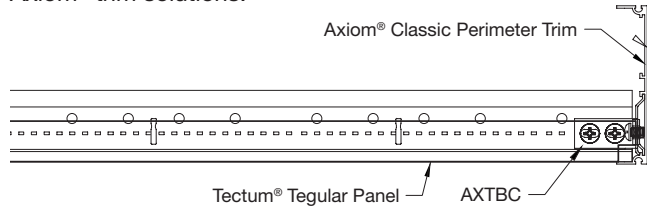

SECTION 7: TRANSITIONS

Professional transitions from TECTUM to another ceiling surface, at the same level, or at a height difference, can be achieved with Axiom Transitions.

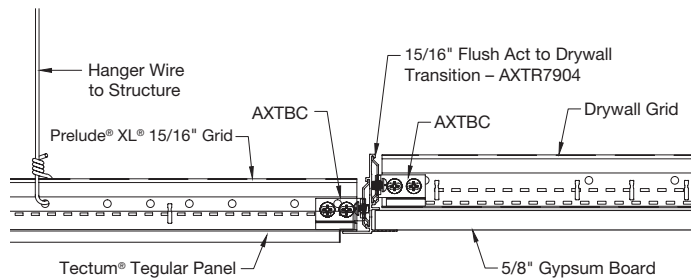

SECTION 8: SPECIAL CONSIDERATIONS

8.1 Sloping Ceilings

For specific installation guidance for sloped ceilings, reference the Sloped Ceilings Technical Guide BPCS-5618.

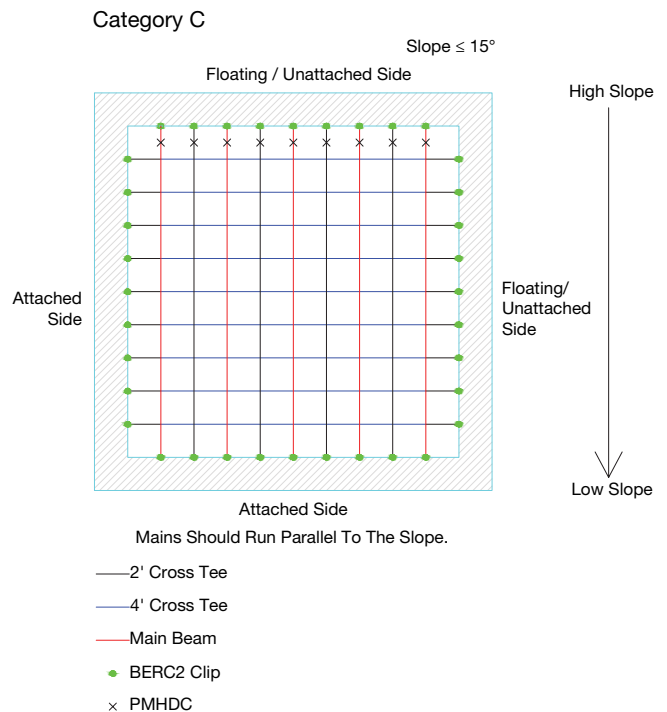

Category C

$15^\circ < \text{Slope} \leq 30^\circ$

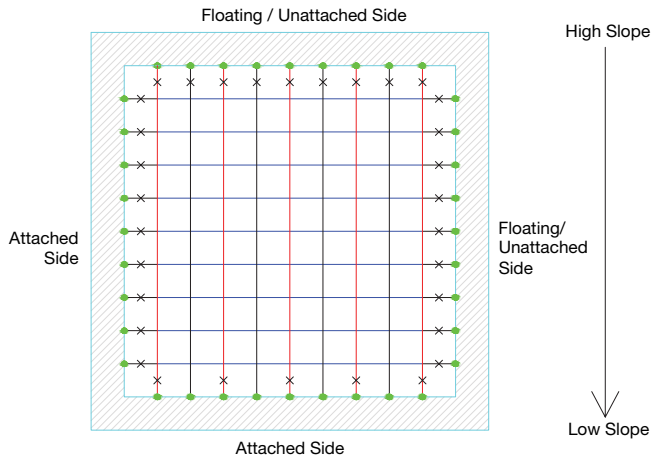

- 2' Cross Tee
- 4' Cross Tee
- Main Beam
- BERC2 Clip
- × PMHDC

Category D,E,F

$\text{Slope} \leq 15^\circ$

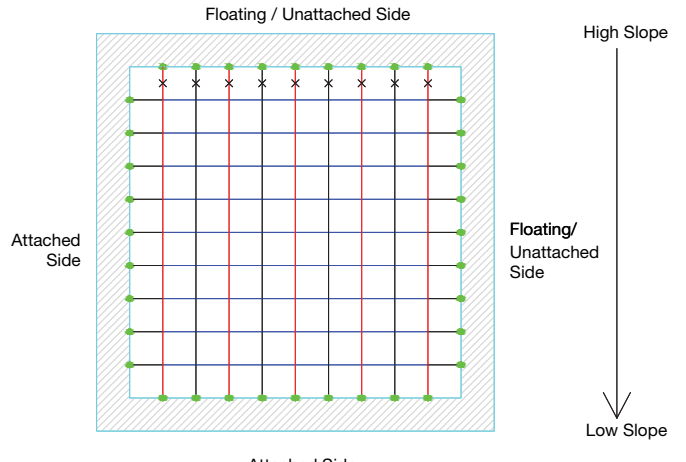

Mains Should Run Parallel To The Slope.

- 2' Cross Tee
- 4' Cross Tee
- Main Beam
- BERC2 Clip
- × PMHDC

Category C

$15^\circ < \text{Slope} \leq 30^\circ$ *

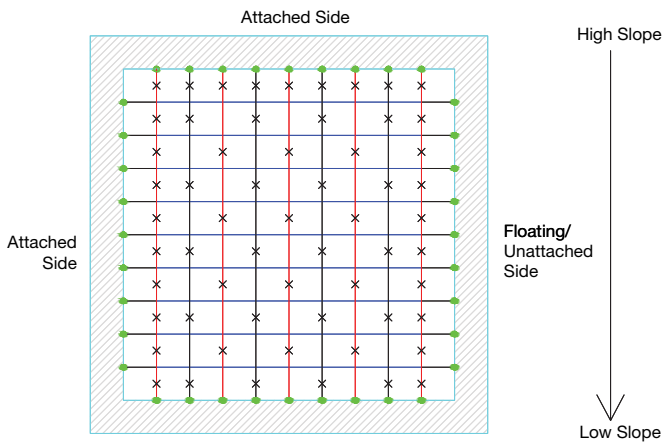

* Must Use Heavy Duty Grid To Achieve Maximum Slope Of 30°
If Using Intermediate Duty Grid, Maximum Slope Is 25° .

- 2' Cross Tee
- 4' Cross Tee
- Main Beam
- BERC2 Clip
- × PMHDC

8.2 Single tee insertion/ASHLAR systems

TECTUM® Lay-in and Tegular Ceiling panels can be installed in an ashlar (or running bond) system. See the STAC installation instructions, BPLA-297835.

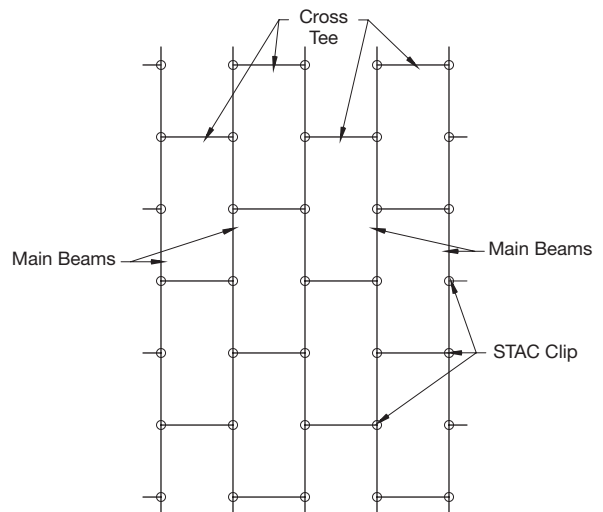
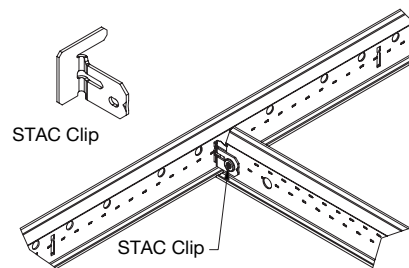

9: SEISMIC INSTALLATIONS (DEF)

NOTE: In OSHPD, DSA areas, TECTUM® Lay-in and Tegular ceiling panels will need to be mechanically fastened to the deck. Please consult with the Structural Engineer/Code Expert to determine appropriate solution for your application.

The requirements listed here represent the manufacturer's minimum acceptable installation recommendations, and may be subject to additional requirements established by the local authority having jurisdiction.

- All installations shall follow ASTM C636
- All references to suspension component duty ratings are per ASTM C635
- All manufacturers' suspension system components must be minimum Heavy-duty

In Seismic zones, Heavy Duty Main Beams (Item 7301) will be installed 48" O.C., with 4' cross tees (Item XL7341) perpendicular to the main beams at 24" O.C. For 2 x 2' panel installation, 2' cross tees (Item 8320) will span the midpoints of the 4' cross tees.

For Lay-in panels, (Item 7800) Wall Angle Molding can be used.

For Tegular panels, (Item 7897) Shadow Molding should be used. Alternatively, (Item 7800) molding can be used along with BERC2 clips. However, this solution could result in "mouse holes" at the perimeter.

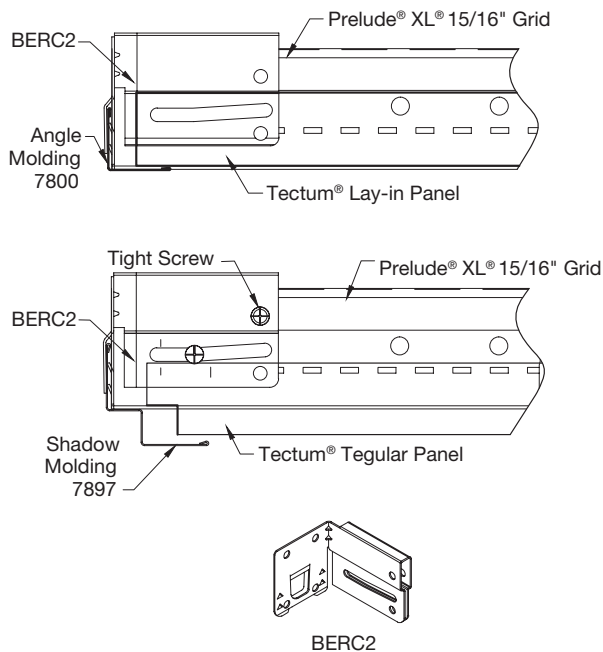

Seismic suspension system installation follows the Armstrong® Seismic Rx® ESR-1308 guidelines of installation for both IBC C & D installations. Seismic Rx installation method can be found in the Seismic Ceiling Installation Guide BPCS-4141.

Seismic Rx® Cat C, D, E & F

Ceiling installation should conform to basic minimums established in ASTM C636.

- Minimum 7/8" wall molding
- Suspension system must be attached on two adjacent walls – opposite walls require BERC2 with 3/4" clearance
- BERC2 maintains main beam and cross tee spacing; no other components required
- Heavy-duty systems as identified in ICC-ESR-1308
- Safety wires required on light fixtures
- Ceiling areas over 1,000 SF must have horizontal restraint wire or rigid bracing
- Perimeter support wires within 8"
- Ceiling areas over 2,500 SF must have seismic separation joints or full height partitions
- Ceilings without rigid bracing must have 2" oversized trim rings for sprinklers and other penetrations
- Changes in ceiling plane must have positive bracing.
- Cable trays and electrical conduits must be independently supported and braced
- Suspended ceilings can be subject to special inspection

MORE INFORMATION

For more information, or for an Armstrong Ceilings representative, call 1 877 276 7876.

For complete technical information, detail drawings, CAD design assistance, installation information, and many other technical services, call TechLine customer support at 1 877 276 7876 or FAX 1 800 572 TECH.

For the latest product selection and specification data, visit armstrongceilings.com/TECTUM.

Sherwin-Williams® is a registered trademark of The Sherwin-Williams Company; Inspiring Great Spaces® is a registered trademark of AFI Licensing LLC; All other trademarks used herein are the property of AWI Licensing LLC and/or its affiliates

© 2018 AWI Licensing LLC • Printed in the United States of America

BPLA-298763-618

Armstrong®
CEILING & WALL SOLUTIONS