

new WOODWORKS® Grille – Select
Solid Western Hemlock Ceiling Panels (Quoted)



WoodWorks Grille - Select Western Hemlock ceiling panels in Umber

Western Hemlock panels are available in a wide range of slat variations, offering thousands of configuration options.

KEY SELECTION ATTRIBUTES

- new** • Western Hemlock species is available in a variety of stains and clear coat
- new** • Coordinating solid wood trim in 3/4", 1" and 1-3/8" thickness in 4" and 6" nominal heights
- The natural warmth of wood can contribute to biophilic designs and building certification standards like the WELL™ v2 "Nature and Place" feature
- Panels are available in 3' to 10' lengths with 2-8 slats per panel
- Optional fleece provides 0.55 NRC and hides the plenum for a clean, finished visual
- CleanAssure™ family of products – includes disinfectable panels, suspension systems, and trim
- FSC® Certified wood is available as a custom option (FSC® C007626); Contact ASQuote@armstrong.com

new WOODWORKS® Grille – Select
Solid Western Hemlock Ceiling Panels (Quoted)

LEED V5

COMMON MATERIALS FRAMEWORK	
Climate Health	
Human Health	
Ecosystem Health	
Circular Economy	✓
OCCUPANT EXPERIENCE	Acoustics ✓

FINISHES ON WESTERN HEMLOCK



Hemlock Clear Coat (HC)



Sand (HS)



Buckskin (HB)



Honey (HH)



Ginger (HG)

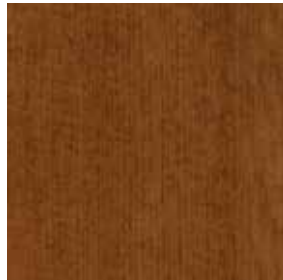

Fallow (HF)



Russet (HR)



Sepia (HP)



Umber (HU)



Merlot (HM)



Kohl (HK)



Jet (HJ)

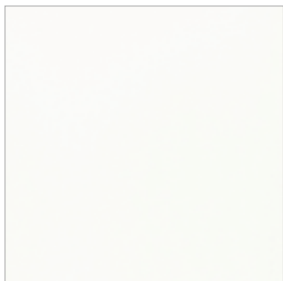

Snow (HW)

CUSTOM FINISHES



Custom Wood
Species and Finishes
Available



WOODWORKS®

WOODWORKS® Grille – Select
Solid Western Hemlock Ceiling Panels (Quoted)

LEED V5

COMMON MATERIALS FRAMEWORK	Climate Health	
Human Health	Ecosystem Health	
	Circular Economy	✓
OCCUPANT EXPERIENCE	Acoustics	✓

PANEL CONFIGURATIONS 12" width, 3/4" slat (Available in 3' to 10' lengths)

3/4" SLAT WIDTH

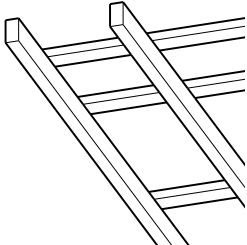
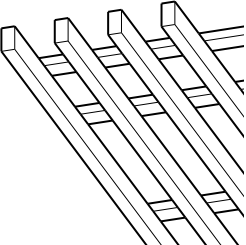
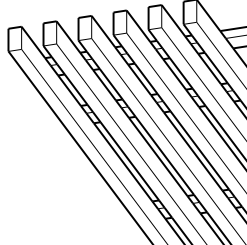
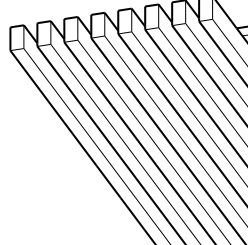
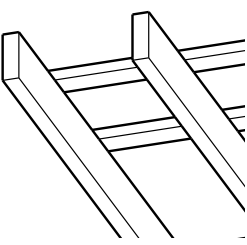
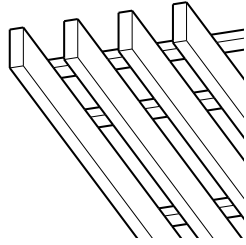
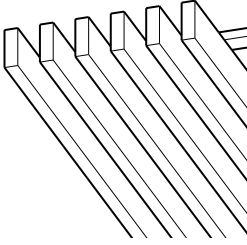
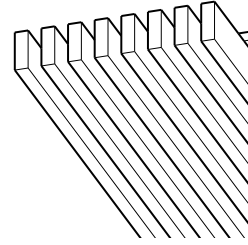
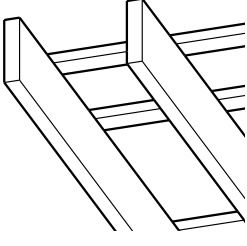
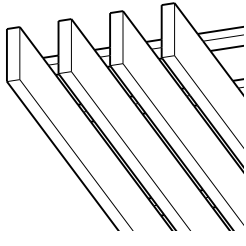
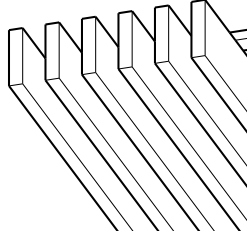
	2 Slats Per Panel 88% Open Area	4 Slats Per Panel 75% Open Area	6 Slats Per Panel 63% Open Area	8 Slats Per Panel 50% Open Area
1-3/8" SLAT HEIGHT*	 Item 1012F51L_S34_ _◆	 Item 1014F51L_S34_ _◆	 Item 1016F51L_S34_ _◆	 Item 1018F51L_S34_ _◆
2-1/4" SLAT HEIGHT*	 Item 1012F51L_S02_ _◆	 Item 1014F51L_S02_ _◆	 Item 1016F51L_S02_ _◆	 Item 1018F51L_S02_ _◆
3-1/4" SLAT HEIGHT	 Item 1012F51L_S03_ _◆	 Item 1014F51L_S03_ _◆	 Item 1016F51L_S03_ _◆	

◆ When specifying or ordering, include the single digit for the panel length and the two-letter finish suffix (e.g., 1014F51L8S03HS – 4 slats, 3/4 × 96 × 3-1/4" in Sand).

ITEM NUMBER KEY

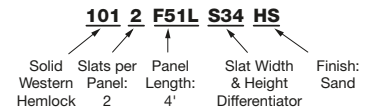

WOODWORKS® Grille – Select
Solid Western Hemlock Ceiling Panels (Quoted)

LEED V5

COMMON MATERIALS FRAMEWORK	Climate Health	
Human Health	Ecosystem Health	
	Circular Economy	✓
OCCUPANT EXPERIENCE	Acoustics	✓

PANEL CONFIGURATIONS 12" width, 1" slat (Available in 3' to 10' lengths)

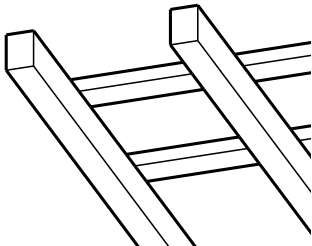
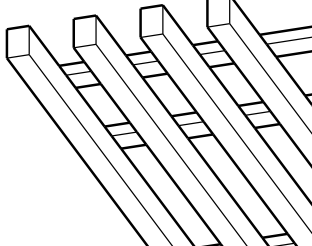
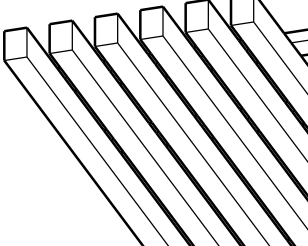
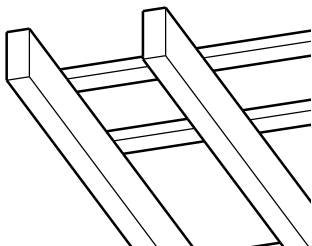
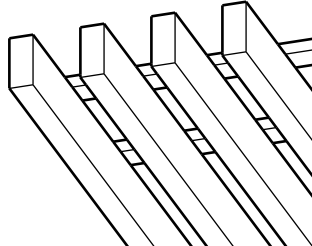
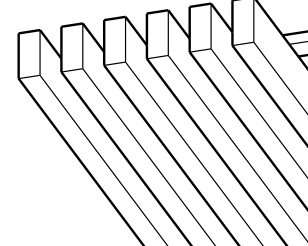
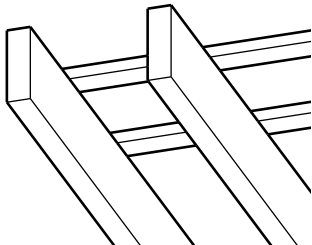
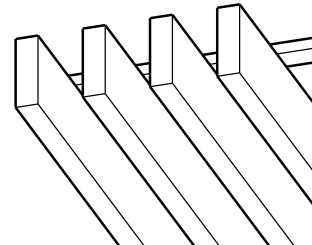
	1" SLAT WIDTH		
	2 Slats Per Panel 83% Open Area	4 Slats Per Panel 67% Open Area	6 Slats Per Panel 50% Open Area
1-3/8" SLAT HEIGHT*	 Item 1012F51L_S35_ _◆	 Item 1014F51L_S35_ _◆	 Item 1016F51_S35_ _◆
2-1/4" SLAT HEIGHT*	 Item 1012F51L_S06_ _◆	 Item 1014F51L_S06_ _◆	 Item 1016F51_S06_ _◆
3-1/4" SLAT HEIGHT	 Item 1012F51L_SS07_ _◆	 Item 1014F51L_S07_ _◆	

◆ When specifying or ordering, include the single digit for the panel length and the two-letter finish suffix (e.g., 1014F51L8S03HS - 4 slats, 3/4 × 96 × 3-1/4" in Sand).

ITEM NUMBER KEY

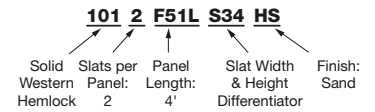

WOODWORKS® Grille – Select
Solid Western Hemlock Ceiling Panels (Quoted)

PANEL CONFIGURATIONS 12" width, 1-3/8" slat (Available in 3' to 10' lengths)

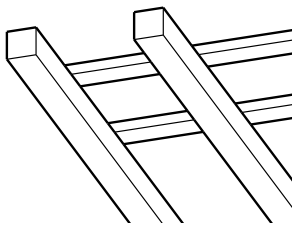
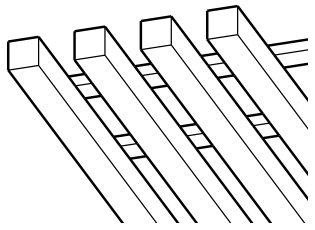
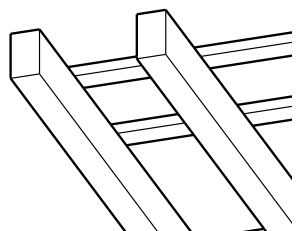
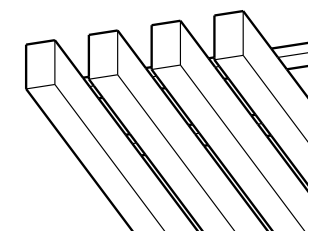
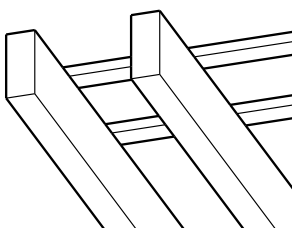
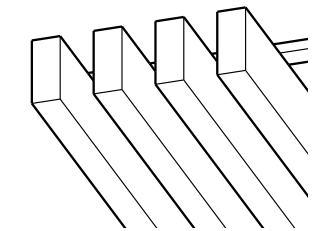
	1-3/8" SLAT WIDTH	
	2 Slats Per Panel 77% Open Area	4 Slats Per Panel 54% Open Area
1-3/8" SLAT HEIGHT*	 Item 1012F51L_S36_ _◆	 Item 1014F51L_S36_ _◆
2-1/4" SLAT HEIGHT*	 Item 1012F51L_S37_ _◆	 Item 1014F51L_S37_ _◆
3-1/4" SLAT HEIGHT	 Item 1012F51L_S38_ _◆	 Item 1014F51L_S38_ _◆

◆ When specifying or ordering, include the single digit for the panel length and the two-letter finish suffix (e.g., 1014F51L8S03HS – 4 slats, 3/4 × 96 × 3-1/4" in Sand).

ITEM NUMBER KEY

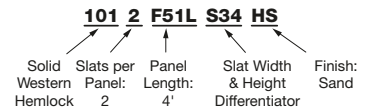

new WOODWORKS® Grille – Select
Solid Western Hemlock Ceiling Panels (Quoted)

LEED V5

COMMON MATERIALS FRAMEWORK	Climate Health	
Human Health	Ecosystem Health	
	Circular Economy	✓
OCCUPANT EXPERIENCE	Acoustics	✓

VISUAL SELECTION

ACOUSTICAL INFORMATION

	Item No. ◆	Slat Dimensions		Space Between Slats (Nominal)	LBS/SQFT	% Open Area	Panel Length		Panel Item No.	NRC	
		Width	Depth								
WOODWORKS® Grille – Select with Fleece Backer	BPAS1023F51L_S34_ _	3/4"	1-3/8"	3-1/4"	1	81	L3	3'	Panel with Fleece 6657 5823 5823 with fleece	 0.55 0.75 0.75 0.85	
	BPAS1023F51L_S02_ _	3/4"	2-1/4"	3-1/4"	1	81	L4	4'			
	BPAS1023F51L_S03_ _	3/4"	3-1/4"	3-1/4"	1.5	81	L5	5'			
	BPAS1023F51L_S35_ _	1"	1-3/8"	3"	1	75	L6	6'			
	3 slats per panel	BPAS1023F51L_S06_ _	1"	2-1/4"	3"	1.5	75	L7			7'
	BPAS1023F51L_S07_ _	1"	3-1/4"	3"	2	75	L8	8'			
	BPAS1023F51L_S36_ _	1-3/8"	1-3/8"	2-5/8"	1.5	66	L9	9'			
	BPAS1023F51L_S37_ _	1-3/8"	2-1/4"	2-5/8"	2	66	L0	10'			
4 slats per panel	BPAS1024F51L_S34_ _	3/4"	1-3/8"	2-1/4"	1	75					
	BPAS1024F51L_S02_ _	3/4"	2-1/4"	2-1/4"	1.5	75					
	BPAS1024F51L_S03_ _	3/4"	3-1/4"	2-1/4"	2	75					
	BPAS1024F51L_S35_ _	1"	1-3/8"	2"	1.5	67					
	4 slats per panel	BPAS1024F51L_S06_ _	1"	2-1/4"	2"	2	67				
	BPAS1024F51L_S07_ _	1"	3-1/4"	2"	3	67					
	BPAS1024F51L_S36_ _	1-3/8"	1-3/8"	1-5/8"	1.5	54					
	BPAS1024F51L_S37_ _	1-3/8"	2-1/4"	1-5/8"	2.5	54					
5 slats per panel	BPAS1025F51L_S34_ _	3/4"	1-3/8"	1-5/8"	1	69					
	BPAS1025F51L_S02_ _	3/4"	2-1/4"	1-5/8"	2	69					
	BPAS1025F51L_S03_ _	3/4"	3-1/4"	1-5/8"	2.5	69					
	5 slats per panel	BPAS1025F51L_S35_ _	1"	1-3/8"	1-3/8"	1.5	58				
	BPAS1025F51L_S06_ _	1"	2-1/4"	1-3/8"	2.5	58					
	BPAS1025F51L_S07_ _	1"	3-1/4"	1-3/8"	3.5	58					
	BPAS1025F51L_S36_ _	1-3/8"	1-3/8"	1"	2	43					
	BPAS1025F51L_S37_ _	1-3/8"	2-1/4"	1"	3.5	43					

◆ When specifying or ordering, include the single digit for the panel length and the two-letter finish suffix (e.g., 1014F51L8S03HS – 4 slats, 3/4 × 96 × 3-1/4" in Sand).



WOODWORKS®

new WOODWORKS® Grille – Select
Solid Western Hemlock Ceiling Panels (Quoted)

LEED V5

COMMON MATERIALS FRAMEWORK	Climate Health	
	Ecosystem Health	
OCCUPANT EXPERIENCE	Circular Economy	✓
	Acoustics	✓

VISUAL SELECTION

ACOUSTICAL INFORMATION

	Item No. ◆	Slat Dimensions		Space Between Slats (Nominal)	LBS/SQFT	% Open Area	Panel Length		
		Width	Depth						
WOODWORKS® Grille – Select with Fleece Backer	BPAS1026F51L_S34_ _	3/4"	1-3/8"	1-1/4"	1.5	63	L3	3'	
	BPAS1026F51L_S02_ _	3/4"	2-1/4"	1-1/4"	2.5	63	L4	4'	
	6 slats per panel	BPAS1026F51L_S03_ _	3/4"	3-1/4"	1-1/4"	3	63	L5	5'
		BPAS1026F51L_S35_ _	1"	1-3/8"	1"	2	50	L6	6'
		BPAS1026F51L_S06_ _	1"	2-1/4"	1"	3	50	L7	7'
								L8	8'
7 slats per panel	BPAS1027F51L_S34_ _	3/4"	1-3/8"	11/16"	1.5	56	L9	9'	
	BPAS1027F51L_S02_ _	3/4"	2-1/4"	11/16"	2.5	56			
	BPAS1027F51L_S35_ _	1"	1-3/8"	11/16"	2	42	L0	10'	
8 slats per panel	BPAS1028F51L_S34_ _	3/4"	1-3/8"	3/4"	2	50			
	BPAS1028F51L_S02_ _	3/4"	2-1/4"	3/4"	3	50			

Dots represent high level of performance.

Panel Item No.	NRC
Panel with Fleece	0.55
6657	0.75
5823	0.75
5823 with fleece	0.85

◆ When specifying or ordering, include the single digit for the panel length and the two-letter finish suffix (e.g., 1014F51L8S03HS – 4 slats, 3/4 x 96 x 3-1/4" in Sand).

NRC

DEF



WOODWORKS®

WOODWORKS® Grille – Select
Solid Western Hemlock Ceiling Panels (Quoted)

LEED V5

COMMON MATERIALS FRAMEWORK	Climate Health	
Human Health	Ecosystem Health	
	Circular Economy	✓
OCCUPANT EXPERIENCE	Acoustics	✓

VISUAL SELECTION

	Item No. ◆	Slat Dimensions		Space Between Slats (Nominal)	LBS/ SQFT	% Open Area	Panel Length		
		Width	Depth						
WOODWORKS® Grille – Select (Panel Only)	BPAS1012F51L_S34_ _	3/4"	1-3/8"	5-1/4"	0.5	88	L3	3'	
	BPAS1012F51L_S02_ _	3/4"	2-1/4"	5-1/4"	1	88	L4	4'	
	BPAS1012F51L_S03_ _	3/4"	3-1/4"	5-1/4"	1	88	L5	5'	
	BPAS1012F51L_S35_ _	1"	1-3/8"	5"	0.5	83	L6	6'	
	2 slats per panel	BPAS1012F51L_S06_ _	1"	2-1/4"	5"	1	83	L7	7'
	BPAS1012F51L_S07_ _	1"	3-1/4"	5"	1.5	83	L8	8'	
	BPAS1012F51L_S36_ _	1-3/8"	1-3/8"	4-5/8"	1	77	L9	9'	
	BPAS1012F51L_S37_ _	1-3/8"	2-1/4"	4-5/8"	1.5	77	L0	10'	
	BPAS1012F51L_S38_ _	1-3/8"	3-1/4"	4-5/8"	2	77			
	BPAS1013F51L_S34_ _	3/4"	1-3/8"	3-1/4"	1	81			
	BPAS1013F51L_S02_ _	3/4"	2-1/4"	3-1/4"	1	81			
	BPAS1013F51L_S03_ _	3/4"	3-1/4"	3-1/4"	1.5	81			
	BPAS1013F51L_S35_ _	1"	1-3/8"	3"	1	75			
3 slats per panel	BPAS1013F51L_S06_ _	1"	2-1/4"	3"	1.5	75			
	BPAS1013F51L_S07_ _	1"	3-1/4"	3"	2	75			
	BPAS1013F51L_S36_ _	1-3/8"	1-3/8"	2-5/8"	1.5	66			
	BPAS1013F51L_S37_ _	1-3/8"	2-1/4"	2-5/8"	2	66			
	BPAS1013F51L_S38_ _	1-3/8"	3-1/4"	2-5/8"	3	66			
	BPAS1014F51L_S34_ _	3/4"	1-3/8"	2-1/4"	1	75			
	BPAS1014F51L_S02_ _	3/4"	2-1/4"	2-1/4"	1.5	75			
	BPAS1014F51L_S03_ _	3/4"	3-1/4"	2-1/4"	2	75			
	BPAS1014F51L_S35_ _	1"	1-3/8"	2"	1.5	67			
4 slats per panel	BPAS1014F51L_S06_ _	1"	2-1/4"	2"	2	67			
	BPAS1014F51L_S07_ _	1"	3-1/4"	2"	3	67			
	BPAS1014F51L_S36_ _	1-3/8"	1-3/8"	1-5/8"	1.5	54			
	BPAS1014F51L_S37_ _	1-3/8"	2-1/4"	1-5/8"	2.5	54			
	BPAS1014F51L_S38_ _	1-3/8"	3-1/4"	1-5/8"	4	54			

◆ When specifying or ordering, include the single digit for the panel length and the two-letter finish suffix (e.g., 1014F51LBS03HS – 4 slats, 3/4 × 96 × 3-1/4" in Sand).

ACOUSTICAL INFORMATION

Dots represent high level of performance.

Panel Item No.	NRC
	0.55
Panel with Fleece	0.75
6657	0.75
5823	0.75
5823 with fleece	0.85



WOODWORKS®

WOODWORKS® Grille – Select
Solid Western Hemlock Ceiling Panels (Quoted)

LEED V5

COMMON MATERIALS FRAMEWORK	Climate Health	
	Human Health	
OCCUPANT EXPERIENCE	Circular Economy	✓
	Acoustics	✓

VISUAL SELECTION

	Item No. ◆	Slat Dimensions		Space Between Slats (Nominal)	LBS/SGFT	% Open Area	Panel Length		
		Width	Depth						
WOODWORKS® Grille – Select (Panel Only)	BPAS1015F51L_S34_ _	3/4"	1-3/8"	1-5/8"	1	69	L3	3'	
	BPAS1015F51L_S02_ _	3/4"	2-1/4"	1-5/8"	2	69	L4	4'	
	BPAS1015F51L_S03_ _	3/4"	3-1/4"	1-5/8"	2.5	69	L5	5'	
	5 slats per panel	BPAS1015F51L_S35_ _	1"	1-3/8"	1-3/8"	1.5	58	L6	6'
		BPAS1015F51L_S06_ _	1"	2-1/4"	1-3/8"	2.5	58	L7	7'
		BPAS1015F51L_S07_ _	1"	3-1/4"	1-3/8"	3.5	58	L8	8'
		BPAS1015F51L_S36_ _	1-3/8"	1-3/8"	1"	2	43	L9	9'
		BPAS1015F51L_S37_ _	1-3/8"	2-1/4"	1"	3.5	43	L0	10'
6 slats per panel	BPAS1016F51L_S34_ _	3/4"	1-3/8"	1-1/4"	1.5	63			
	BPAS1016F51L_S02_ _	3/4"	2-1/4"	1-1/4"	2.5	63			
	BPAS1016F51L_S03_ _	3/4"	3-1/4"	1-1/4"	3	63			
	BPAS1016F51L_S35_ _	1"	1-3/8"	1"	2	50			
	BPAS1016F51L_S06_ _	1"	2-1/4"	1"	3	50			
7 slats per panel	BPAS1017F51L_S34_ _	3/4"	1-3/8"	11/16"	1.5	56			
	BPAS1017F51L_S02_ _	3/4"	2-1/4"	11/16"	2.5	56			
	BPAS1017F51L_S35_ _	1"	1-3/8"	11/16"	2	42			
8 slats per panel	BPAS1018F51L_S34_ _	3/4"	1-3/8"	3/4"	2	50			
	BPAS1018F51L_S02_ _	3/4"	2-1/4"	3/4"	3	50			

ACOUSTICAL INFORMATION

Dots represent high level of performance.

Panel Item No.	NRC
Panel with Fleece	0.55
6657	0.75
5823	0.75
5823 with fleece	0.85

◆ When specifying or ordering, include the single digit for the panel length and the two-letter finish suffix (e.g., 1014F51L8S03HS – 4 slats, 3/4 × 96 × 3-1/4" in Sand).



WOODWORKS®

new WOODWORKS® Grille – Select
Solid Western Hemlock Ceiling Panels (Quoted)

LEED V5

COMMON MATERIALS FRAMEWORK	Climate Health	
	Ecosystem Health	
OCCUPANT EXPERIENCE	Circular Economy	✓
	Acoustics	✓

ACCESSORIES

	Item No.	Description	Dimensions Nominal W x L x H (Inches)	Color	PCS/ CTN
Suspension Systems	7301BL	Prelude® XL® 12' HD Main Beam	15/16 x 144 x 1-11/16"	Black	20
	XL7341BL	Prelude XL 4' Cross Tee	15/16 x 48 x 1-11/16"	Black	60
	XL8320BL	Prelude XL 2' Cross Tee	15/16 x 24 x 1-3/8"	Black	60
Perimeter Trim	BPAS1009F51H4T06_ _	4" x 3/4" Western Hemlock Solid Wood Trim with 4 Clips (Item 5925)	4 x 96 x 3/4"	All Finishes	1
	BPAS1009F51H4T08_ _	4" x 1" Western Hemlock Solid Wood Trim with 4 Clips (Item 5925)	4 x 96 x 1"	All Finishes	1
	BPAS1009F51H4T11_ _	4" x 1-3/8" Western Hemlock Solid Wood Trim with 4 Clips (Item 5925)	4 x 96 x 1-3/8"	All Finishes	1
	BPAS1009F51H6T06_ _	6" x 3/4" Western Hemlock Solid Wood Trim with 4 Clips (Item 5925)	6 x 96 x 3/4"	All Finishes	1
	BPAS1009F51H6T08_ _	6" x 1" Western Hemlock Solid Wood Trim with 4 Clips (Item 5925)	6 x 96 x 1"	All Finishes	1
	BPAS1009F51H6T11_ _	6" x 1-3/8" Western Hemlock Solid Wood Trim with 4 Clips (Item 5925)	6 x 96 x 1-3/8"	All Finishes	1
Acoustical Infill Panels	5823	BioAcoustic™ Infill Panel	24 x 24 x 5/8"	Black Matte	12
	6657	BioAcoustic Infill Panel	11 x 48 x 5/8"	Black Matte	12
	7891	12-Gauge Soft Hanger Wire	144" Length	N/A	140
	6459BL	Uptight Clip	5-1/2" x 1-3/4"	Black	25
	RC2BL	RC2 Radius Clip	N/A	Black	205
	7239	Adjustable Trim Clip	-	N/A	50
	1010BL	WoodWorks Grille - Select Flat Backer	7/8 x 12 x 1/2"	Black	18

NOTE: For integration with Axiom® trim (Black recommended for use with solid wood).



WOODWORKS®

new WOODWORKS® Grille – Select
Solid Western Hemlock Ceiling Panels (Quoted)

LEED V5

COMMON MATERIALS FRAMEWORK	Climate Health	
Human Health	Ecosystem Health	
	Circular Economy	✓
OCCUPANT EXPERIENCE	Acoustics	✓

SYSTEM INSTALLATION DETAILS

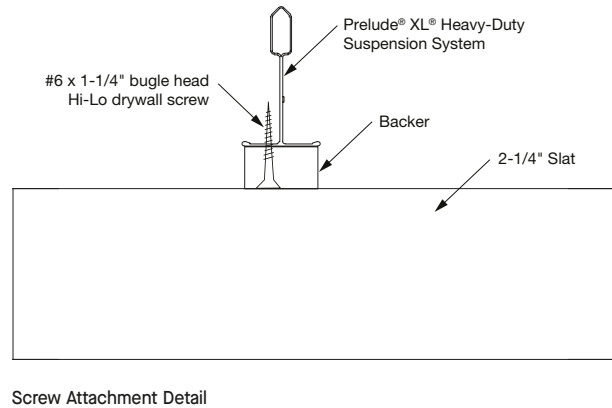
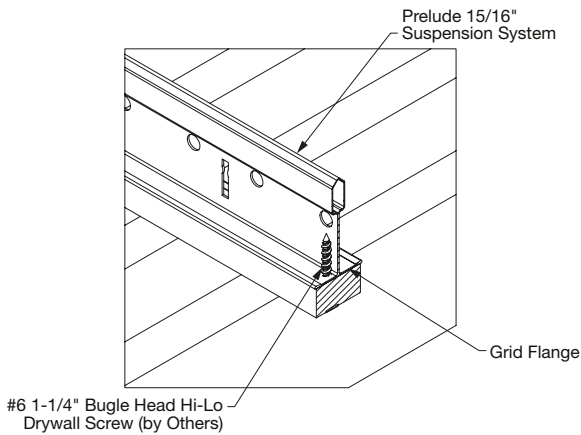

SUSPENSION SYSTEMS (Heavy-duty)

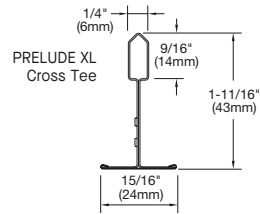
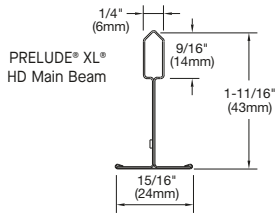

PHYSICAL DATA

Material
Slats – solid Western Hemlock
Backers – Plywood

Surface Finish
Clear or tinted satin coating on all finishes except SNOW (HW), which has a water-based lacquer finish.

Fire Performance
Class B: ASTM E84 surface burning characteristics. Flame Spread Index 75 or less. Smoke Developed Index 450 or less.
Class A coating is available upon request.

These panels, as with other architectural features located at the ceiling, may obstruct or skew the planned fire sprinkler water distribution pattern, or possibly delay or accelerate the activation of the sprinkler or fire detection systems by channeling heat from a fire either toward or away from the device. Consult a fire protection engineer, NFPA 13, and local codes for guidance where automatic fire detection and suppression systems are present.

Application Considerations
Variation among panels may occur due to the natural characteristics of the wood and grain.

Design Considerations
For installations where slat alignment is critical, please see the WoodWorks Grille – Forté product line.

Infill Panel Use
If no infill panel is used, unfinished parts of the suspension system and Axiom® trim will be visible from below.

Site Conditions
It is very important that panels are climatized prior to installation. Relative humidity between 25% and 55%, and temperatures between 50°F and 86°F, must be maintained.

Seismic Restraint
WoodWorks® Grille - Select panels are engineered for application in all seismic areas when installed per Armstrong installation instructions.

Always consult all applicable local building codes, including seismic design and restraint requirements for the project location.

Cleaning and Disinfecting
Cleaning and CDC approved disinfecting options available on armstrongceilings.com/cleaning

Warranty
Details at armstrongceilings.com/warranty

Weight
Refer to visual selection chart

Minimum Order Quantity
240 SF