

AXIOM® Building Perimeter System

Lutron® Compatible Shade Pockets



Declare.

50% ALUMINUM RECYCLED CONTENT

Calculate LEED contribution at armstrong.com/greengenie

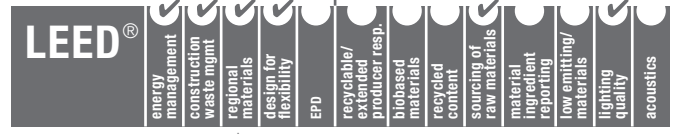

LOCATION DEPENDENT



Axiom® Building Perimeter System with Lutron® Compatible Shade Pocket

Axiom® Lutron® Compatible Shade Pockets are a pre-engineered 10' extruded aluminum pocket that creates the transition between the interior of a building's perimeter and the ceiling plane. These shade pockets can integrate Lutron motorized and manual roller shades and have the ability to tie in to acoustical or drywall systems without any visible fasteners.

KEY SELECTION ATTRIBUTES

- Allows for quality control at the perimeter and reduces risk associated with field fabricated, labor intensive accommodation of air distribution, window pockets and ceiling elevation changes at the perimeter of a building
- Exposed perimeter pocket offering allows for shade concealment in an exposed structure application. Custom colors available.
- Lutron Contract Roller and Sivoia QS motorized roller shading systems are compatible with AXP355L, AXP355LE, AXP355LC, AXP355LS, and AXP355LD
- Lutron Contract Roller manual shading system is compatible with AXP355MA, AXP355MD, AXP355MS, AXP355ME, and AXP355D
- Replaces the framing, boarding, taping, mudding, sanding, and painting commonly used for drywall pockets
- Code compliant seismic product offering
- Armstrong 10-Year Limited Warranty, 30-Year System Warranty

TYPICAL APPLICATIONS

- Offices
- Healthcare
- Higher Education
- High Rise Residential
- Hospitality
- Exposed Structure



Lutron Compatible Shade Pockets

COLOR SELECTION

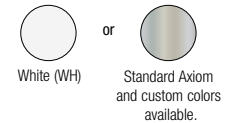







VISUAL SELECTION

Item Number	Description	Dimensions (Inches)	Length	
MOTORIZED SHADE POCKETS – For attachment with 2-1/2" studs				
Acoustical Flange Shade Pocket and End Caps				
<input type="checkbox"/> AXP355L	3-Sided Lutron Compatible Shade Pocket with Acoustical Flange	5 x 5 x 5"	120"	
<input type="checkbox"/> AXP355LECR	Lutron End Cap – Right	5 x 5"		
<input type="checkbox"/> AXP355LECL	Lutron End Cap – Left	5 x 5"		
Drywall Flange Shade Pockets				
<input type="checkbox"/> AXP355LD	3-Sided Lutron Compatible Shade Pocket with Drywall Flange	5 x 5 x 5"	120"	
<input type="checkbox"/> AXP355LDIC	3-Sided Lutron Compatible Shade Pocket with Drywall Flange – Inside Corner	5 x 5"	12"	
<input type="checkbox"/> AXP355LD0C	3-Sided Lutron Compatible Shade Pocket with Drywall Flange – Outside Corner	5 x 5"	12"	

AXIOM® Building Perimeter System

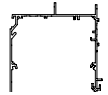
Lutron® Compatible Shade Pockets

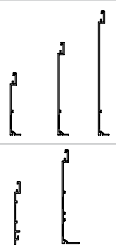





VISUAL SELECTION

Item Number	Description	Dimensions (Inches)	Length	
MOTORIZED SHADE POCKETS – (Cont'd) – For attachment with 2-1/2" studs				
Seismic Flange Shade Pocket and End Caps				
<input type="checkbox"/> AXP355LS	3-Sided Lutron Compatible Shade Pocket with Seismic Flange	5 x 5 x 5"	120"	
<input type="checkbox"/> AXP355LSECR	Lutron Seismic End Cap – Right	5 x 5"		
<input type="checkbox"/> AXP355LSECL	Lutron Seismic End Cap – Left	5 x 5"		
Connection Perimeter Pockets and Connection Accessories				
<input type="checkbox"/> AXP355LC	3-Sided Lutron Compatible Shade Pocket with Connection to Extension/Face Plate Piece	5 x 5 x 5"	120"	
<input type="checkbox"/> AXP355LEEC	Lutron for AXP355LE and AXP355LC End Cap	5 x 5"	120"	
Extensions (custom slotting, perforating and cutouts available)				
Pre-engineered 10' (120") perimeter extensions integrate with perimeter pockets to create larger pockets and higher ceiling elevations.				
<input type="checkbox"/> AXPEP4	4" Axiom Perimeter Extension	4"	120"	
<input type="checkbox"/> AXPEP6	6" Axiom Perimeter Extension	6"	120"	
<input type="checkbox"/> AXPEP8	8" Axiom Perimeter Extension	8"	120"	
<input type="checkbox"/> AXPEP4H	4" Axiom Perimeter Extension – Hook on Both Sides	4"	120"	
<input type="checkbox"/> AXPEPS6	6" Seismic Perimeter Extension with 0.875" Flange	6"	120"	
Face Plates (custom slotting, perforating and cutouts available)				
Pre-engineered 10' (120") extruded aluminum face plates integrate with perimeter pockets and can be slotted to allow for air distribution along the perimeter of a space.				
<input type="checkbox"/> AXPDFP4	4" Axiom Perimeter Face Plate with Acoustical Flange – Unslotted	4" Unslotted	120"	
<input type="checkbox"/> AXPDFP4SLA	4" Axiom Perimeter Face Plate with acoustical Flange – 2 Slot Pattern	4" Slotted 3/4" x 23"	120"	
<input type="checkbox"/> AXPDFP4SLB	4" Axiom Perimeter Face Plate with Acoustical Flange – 1 Slot Pattern	4" Slotted 2-3/4" x 23"	120"	
<input type="checkbox"/> AXPDFP7	7" Axiom Perimeter Face Plate with Acoustical Flange – Unslotted	7" Unslotted	120"	
<input type="checkbox"/> AXPDFP7SLA	7" Axiom Perimeter Face Plate with Acoustical Flange – 2 Slot Pattern	7" Slotted 3/4" x 23"	120"	
<input type="checkbox"/> AXPDFP7SLB	7" Axiom Perimeter Face Plate with Acoustical Flange – 1 Slot Pattern	7" Slotted 2-3/4" x 23"	120"	
<input type="checkbox"/> AXPDFPS7	7" Axiom Seismic Perimeter Face Plate with 0.875" Flange – Unslotted	7" Unslotted	120"	
<input type="checkbox"/> AXPDFPS7LA	7" Axiom Seismic Perimeter Face Plate with 0.875" Flange – 2 Slot Pattern	7" Slotted 3/4" x 23"	120"	
<input type="checkbox"/> AXPDFPS7LB	7" Axiom Seismic Perimeter Face Plate with 0.875" Flange – 1 Slot Pattern	7" Slotted 2-3/4" x 23"	120"	
<input type="checkbox"/> AXPDFP4DT	4" Axiom Perimeter Face Plate with Drywall Flange – Unslotted	4" Unslotted	120"	
<input type="checkbox"/> AXPDFP4DTSLA	4" Axiom Perimeter Face Plate with Drywall Flange – 2 Slot Pattern	4" Slotted 3/4" x 23"	120"	
<input type="checkbox"/> AXPDFP4DTSLB	4" Axiom Perimeter Face Plate with Drywall Flange – 1 Slot Pattern	4" Slotted 2-3/4" x 23"	120"	
<input type="checkbox"/> AXPDFP7DT	7" Axiom Perimeter Face Plate with Drywall Flange – Unslotted	7" Unslotted	120"	
<input type="checkbox"/> AXPDFP7DTSLA	7" Axiom Perimeter Face Plate with Drywall Flange – 2 Slot Pattern	7" Slotted 3/4" x 23"	120"	
<input type="checkbox"/> AXPDFP7DTSLB	7" Axiom Perimeter Face Plate with Drywall Flange – 1 Slot Pattern	7" Slotted 2-3/4" x 23"	120"	

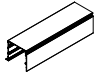
AXIOM® Building Perimeter System

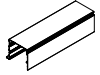
Lutron® Compatible Shade Pockets

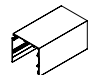
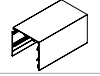
VISUAL SELECTION

Item Number	Description	Dimensions (Inches)	Length	
MOTORIZED SHADE POCKETS – For Traditional Framing				
Acoustical Flange Shade Pockets and Corners				
<input type="checkbox"/> AXP355MLA	3-Sided Lutron Compatible Shade Pocket with Acoustical Flange	5 x 5 x 5"	120"	
<input type="checkbox"/> AXP355MLAIC	3-Sided Lutron Compatible Shade Pocket with Acoustical Flange – Inside Corner	5 x 5"	12"	
<input type="checkbox"/> AXP355MLAOC	3-Sided Lutron Compatible Shade Pocket with Acoustical Flange – Outside Corner	5 x 5"	12"	
Drywall Flange Shade Pockets and Corners				
<input type="checkbox"/> AXP355MLD	3-Sided Lutron Compatible Shade Pocket with Drywall Flange	5 x 5 x 5"	120"	
<input type="checkbox"/> AXP355MLDIC	3-Sided Lutron Compatible Shade Pocket with Drywall Flange – Inside Corner	5 x 5"	12"	
<input type="checkbox"/> AXP355MLDOC	3-Sided Lutron Compatible Shade Pocket with Drywall Flange – Outside Corner	5 x 5"	12"	
Exposed Shade Pocket and End Caps				
<input type="checkbox"/> AXP355LE	3-Sided Exposed Lutron Compatible Shade Pocket	5 x 5 x 5"	120"	
<input type="checkbox"/> AXP355LE__*	3-Sided Exposed Lutron Compatible Shade Pocket, colors	5 x 5 x 5"	120"	
<input type="checkbox"/> AXP355LEEC	Lutron for AXP355LE and AXP355LC End Cap	5 x 5"		
<input type="checkbox"/> AXP355LEEC__*	Lutron Exposed End Cap, colors	5 x 5"		

Motorized Shade Pocket – For Attachment with 2-1/2" Studs
AXP355L

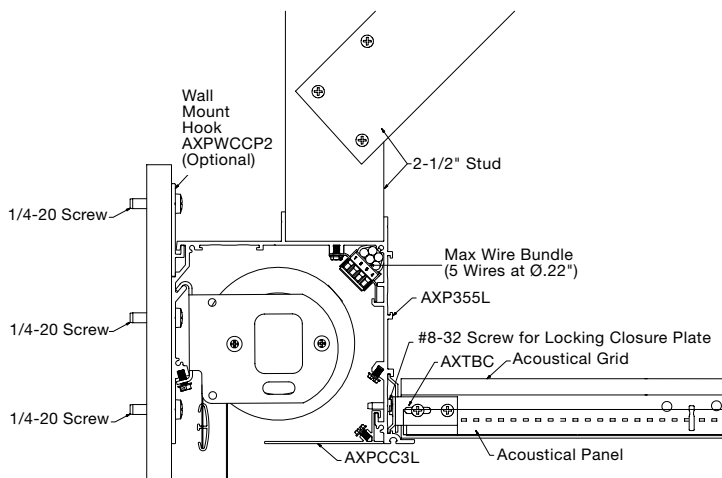



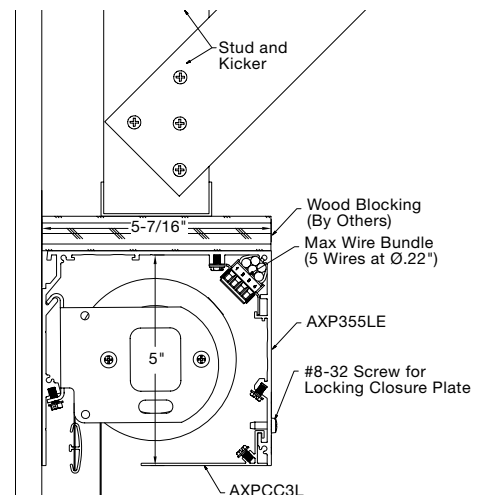







Motorized Shade Pocket – For Traditional Framing
AXP355LE



AXIOM® Building Perimeter System

Lutron® Compatible Shade Pockets

VISUAL SELECTION

Item Number	Description	Dimensions (Inches)	Length	
MANUAL SHADE POCKETS (Cont'd) – For Traditional Framing				
Drywall Flange Pockets and Corners				
<input type="checkbox"/> AXP355MD	Perimeter Pocket with Drywall Flange	5 x 5 x 5"	120"	
<input type="checkbox"/> AXP355MDOSC	Perimeter Pocket with Drywall Flange – Outside Corner	12 x 5 x 12"	12"	
<input type="checkbox"/> AXP355MDISC	Perimeter Pocket with Drywall Flange – Inside Corner	12 x 5 x 12"	12"	
Exposed Pockets and Corners (custom colors available)				
<input type="checkbox"/> AXP355ME	Exposed Application Perimeter Pocket	5 x 5 x 5"	120"	
<input type="checkbox"/> AXP355MEOSC	Exposed Application Perimeter Pocket – Outside Corner	12 x 5 x 12"	12"	
<input type="checkbox"/> AXP355MEISC	Exposed Application Perimeter Pocket – Inside Corner	12 x 5 x 12"	12"	
Seismic Flange Pockets and Corners				
<input type="checkbox"/> AXP355MS	Perimeter Pocket with Seismic (0.875") Flange	5 x 5 x 5"	120"	
<input type="checkbox"/> AXP355MSOSC	Perimeter Pocket with Seismic (0.875") Flange – Outside Corner	12 x 5 x 12"	12"	
<input type="checkbox"/> AXP355MSISC	Perimeter Pocket with Seismic (0.875") Flange – Inside Corner	12 x 5 x 12"	12"	
End Cap				
<input type="checkbox"/> AXP355MEC	Perimeter Pocket End Cap for Traditional Framing Pockets (AXP355MA, AXP355MD, AXP355ME, AXP355MS)	5 x 5"		

Manual Shade Pocket – For Attachment with 2-1/2" Studs
AXP355D

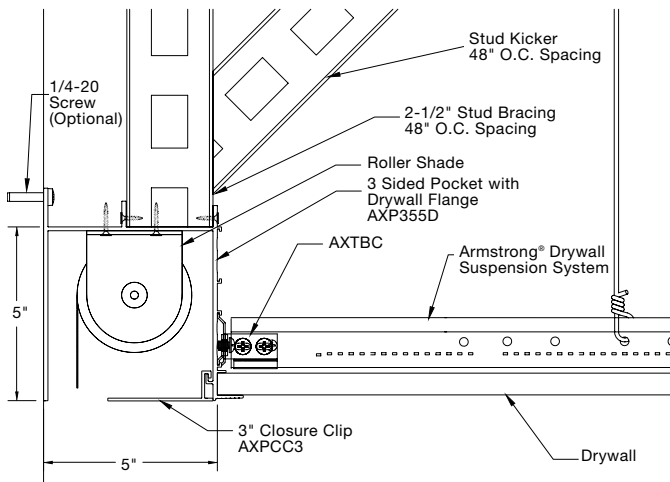



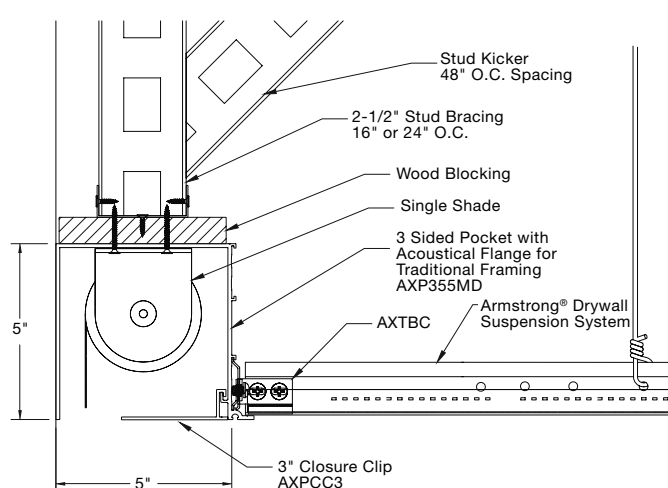

Manual Shade Pocket – For Traditional Framing
AXP355MD



AXIOM® Building Perimeter System

Lutron® Compatible Shade Pockets

VISUAL SELECTION

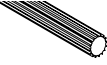
Item Number	Description	Dimensions (Inches)	Length	
ACCESSORIES				
Closure Clip				
<input type="checkbox"/> AXPCC3L	3" Shade Closure Clip	3"	120"	
<input type="checkbox"/> AXPCC3L__*	3" Shade Closure Clip, colors	3"	120"	
Installation Accessories				
<input type="checkbox"/> AXPWCCP2	Axiom Wall Clip with Hook for Closure Clip Attachment	2 x 1/2"	2"	
<input type="checkbox"/> BERCAXT	Axiom Beam End Retaining Clip for Seismic Applications	-	-	
<input type="checkbox"/> AXTBC	Axiom T-Bar Connector Clip			
<input type="checkbox"/> AXSPICE2	Axiom Splice Plate with Setscrews Provides positive lock between abutting pockets		8"	
<input type="checkbox"/> AXPSPLINE	Axiom Building Perimeter Interlocking Spine for connection between perimeter pocket and extension or face plate piece	-	120"	

* Add the 2-letter color suffix to the item number when specifying or ordering (Example: AXP355LE B L, 3-Sided Exposed Lutron Compatible Shade Pocket in Black)

Ensure Compatibility When Specifying

To ensure compatibility, go to www.performanceshadingadvisor.com

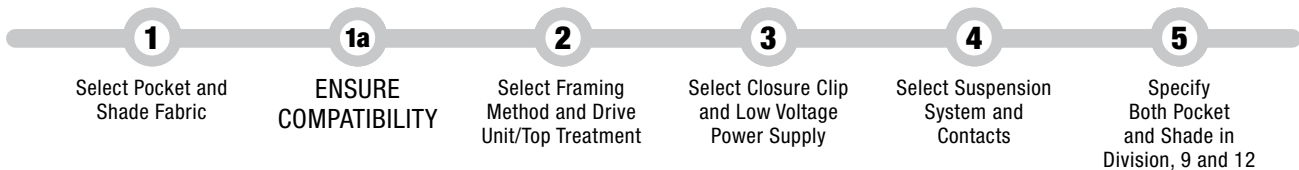

PHYSICAL DATA

Material
Extruded aluminum

Surface Finish
Factory-applied baked polyester paint finish. The areas of the 3-sided perimeter pockets that will be visible once the shade and closure clip are in place will have full paint coverage. The rest of the interior of the pocket will have light paint coverage. The Exposed pockets will have complete paint coverage.

Please contact your local Armstrong representative.

Lutron® Commercial Shades Customer Service

Phone: 1-800-446-1503
Email: commercialshadecs@lutron.com
www.performanceshadingadvisor.com



TechLine / 1 877 276-7876
armstrongceilings.com/lutron

BPCS-5159-620

LEED® is a trademark of the U.S. Green Building Council
Declare® is a trademark of the International Living Future Institute®
Lutron® and Sivoia® are registered trademarks of Lutron Electronics Co., Inc.
All other trademarks used herein are the property of AWI Licensing LLC and/or its affiliates
© 2020 AWI Licensing LLC Printed in the United States of America

