

# FRAMEALL™ DRYWALL GRID HELPS TACKLE ALL THESE CEILING FRAMING CHALLENGES

Flat & Exterior



Curved



Corridors



Soffits



Clouds



Transitions

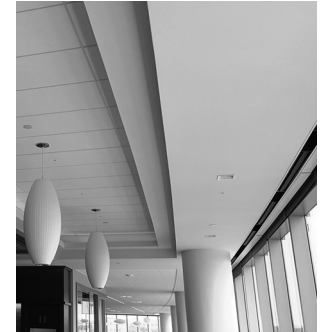

## MEET THE TEAM

Mains & Tees

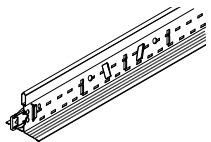

SimpleCurve® KAM

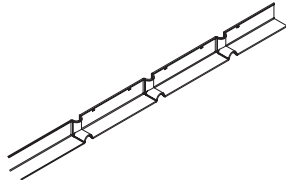

ShortSpan®

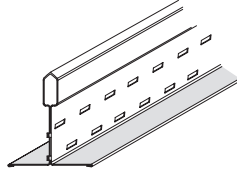

SimpleSoffit®

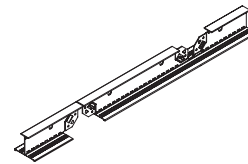

One Piece Axiom® for Drywall

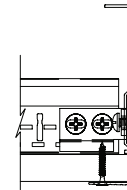

Transition Moldings

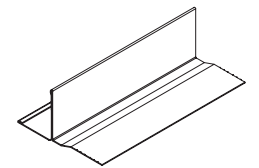

# PRE-ENGINEERED DRYWALL GRID SOLUTIONS FRAMEALL™

Armstrong® Drywall Grid System has been helping contractors bid, frame, and finish drywall projects of all kinds on time, on budget, and on the mark for decades! This is why our Drywall Grid System is now called **FrameAll™ Drywall Grid**.

**INSTALLS UP TO**  
**3X**  
**FASTER**  
THAN TRADITIONAL  
STUD & TRACK

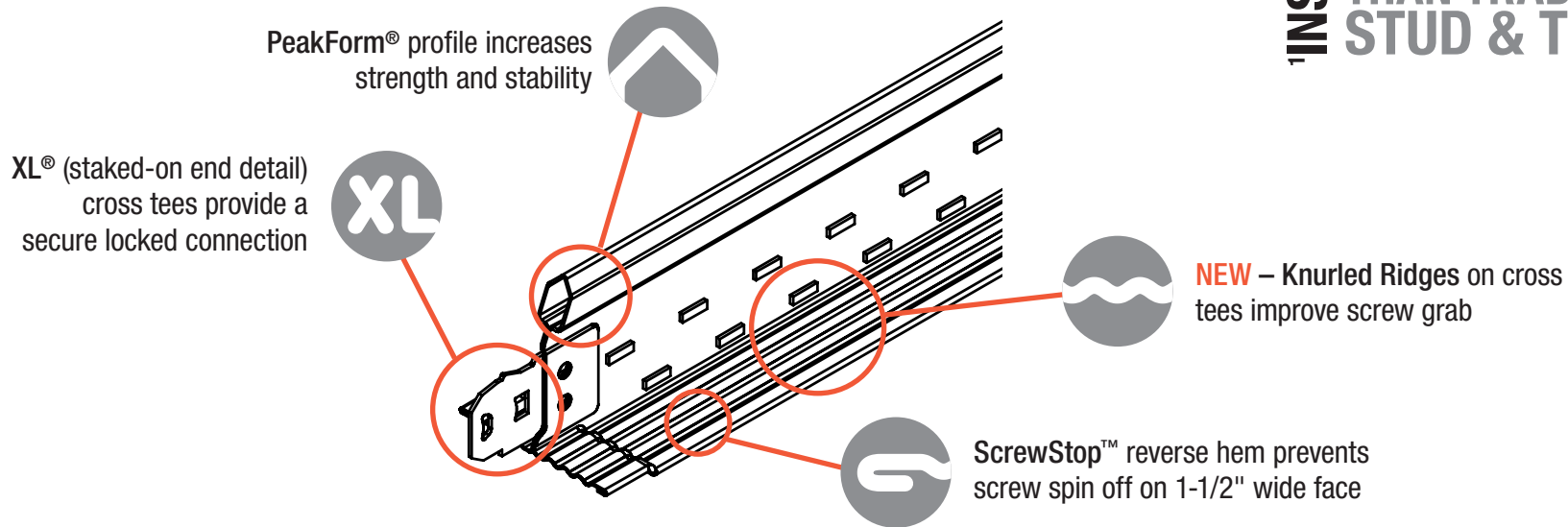

<sup>1</sup> Based on Armstrong Soffit Savings Calculator.