

“ There were many criteria we considered in our selection process for the appropriate ceiling in the lobby of the University of Utah Hospital. This is the introduction to the building, an opportunity to make a new and dramatic first impression. We had some way-finding challenges to address. We wanted a treatment that suggested movement toward the central core. The ability to customize the ceiling panel in the radial shape was a major consideration. We used the ceiling design as well as the floor to facilitate intuitive movement through the space. In addition, we needed a clean, crisp aesthetic to complement the architecture. Not to be overlooked was the need for a high acoustic rating for a lively space. ”

*Michael Costantino, NCIDQ, LEED® AP
Principal, Architectural NEXUS*

Optima® Radial Custom on Prelude® grid in Silver Satin and with 8" Axiom® Classic in White University of Utah Hospital, West Pavilion, Salt Lake City, UT

Cover:
WoodWorks® Radial Custom in Natural Variations™ Light Cherry
St. Mary's Episcopal School,
Windland Smith Rice Building, Memphis, TN





METALWORKS™

Radial Custom

Standard Finish Selection



Custom Finish Selection Due to printing limitations, shade may vary from actual product.

Custom RAL Colors (partial list) Refer to CS-3957 for a sampling of Custom RAL colors. Contact Armstrong Architectural Specialties at 1 877 ARMSTRONG, select options 1-1-4 for custom color matching requests.



Note: For additional perforation and color options, visit armstrongceilings.com/metalworks or contact Architectural Specialties at 1 877 ARMSTRONG and select options 1-1-4.

Key Selection Attributes

- Trapezoidal panels create radial effect
- Distinctive, aesthetic visual
- System typically utilizes the RH200 J-bar and RH215 suspension systems
- All panels are 100% downward accessible
- Panel size determined by design choice
- Variety of perforations and colors available
- NRC 0.65-0.90 available for perforated panels
- Durable, Washable, Scrubbable, Soil-resistant
- Engineered and tested for use in seismic zones
- Class A fire performance

Perforation Options

(Actual 1:1 scale shown)

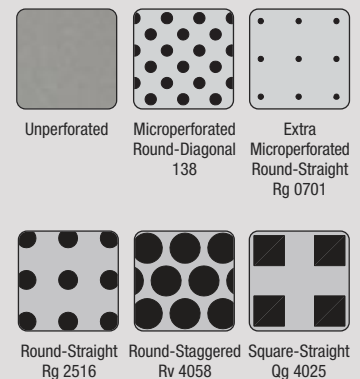



Key Selection Attributes

- Rich, natural wood veneer finishes
- Custom veneer options and veneer management available to coordinate with millwork or other existing wood surfaces
- FSC-certified options available
- Variety of trapezoidal sizes, up to 8' length, and up to 4' width
- Perforation options provide NRC 0.40-0.65 based on pattern and infill selected
- Engineered and tested for applications in seismic zones
- ASTM E84 surface burning characteristics: Composite Class A per ASTM E1264. Flame Spread Index 25 or less. Smoke Developed Index 450 or less

Perforation Options

(Actual 1: 8 scale shown)



Unperforated (W1)



Round-Straight Rg 6006 (W2)

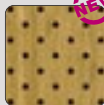

Round-Diagonal Rd 6006 (W3)

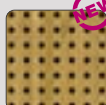

Round-Straight Rg 6011 (W4)

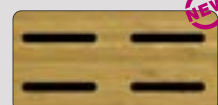

Oval-Straight Slotted Lg 9512 (W5)



Oval-Straight Slotted Lg 9508 (W6)

WOODWORKS®

Radial Custom

Standard Veneer Selection

Natural Variations™ (Real Wood Veneers)



Beech (NBE)



Maple (NMP)



Light Cherry (NLC)



Dark Cherry (NDC)

Constants™ (Real Wood Veneers)



Maple (CMA)



Cherry (CCY)



Walnut (CWA)

Bamboo (Rapidly Renewable)



Patina (BAP)



Native* (BAN)

* Premium veneer option

Custom Veneer Selection (partial list)



Custom Red Oak Rift



Custom African Mahogany Quartered



Custom Anigre Quartered Figured



Custom Cherry Quartered



Custom Sapele Quartered

Note: In addition to standard options, custom veneers, perforations and continuous upturns are available on WoodWorks products. Contact Architectural Specialties for details at 1 877 ARMSTRONG and select options 1-1-4.



OPTIMA®

Radial Custom

Standard Finish Selection

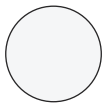

White
(WH)

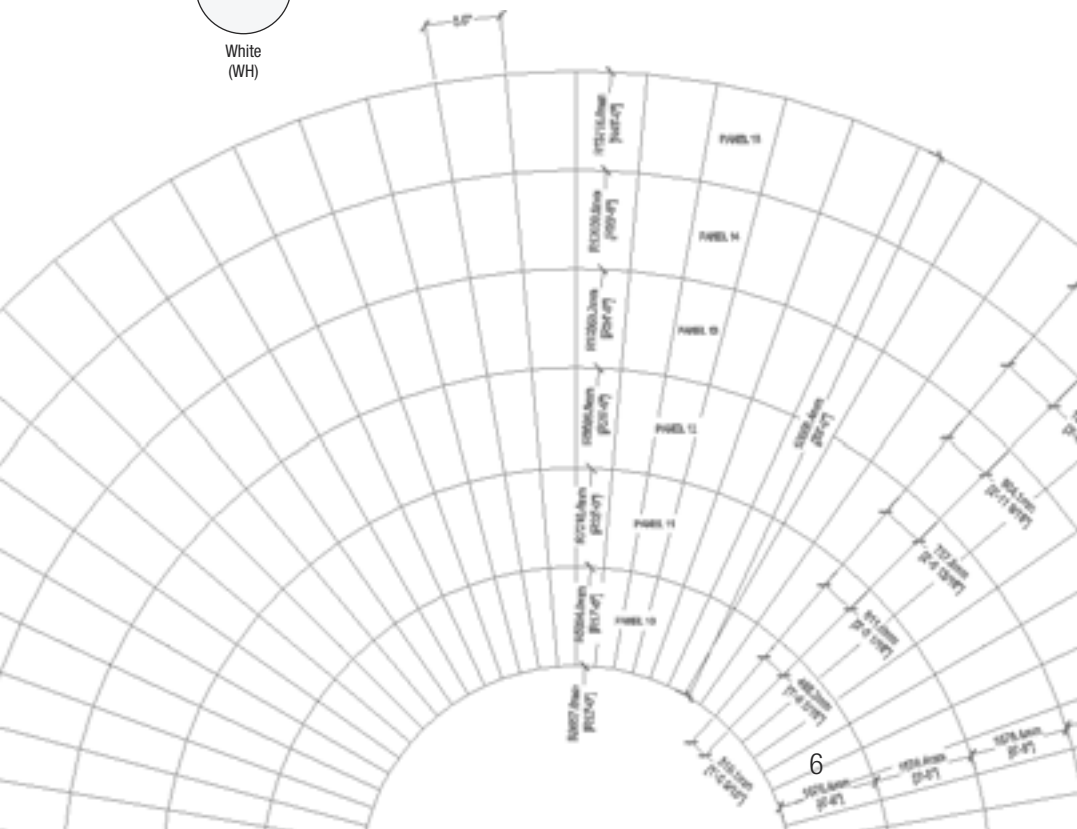

Key Selection Attributes

- Smooth, non-directional finish on scratch-resistant surface
- DuraBrite® surface for excellent durability and superior light reflectance (reduces lighting and energy costs up to 18%)
- Outstanding acoustical performance in both Articulation Class (190-200) and NRC (0.90-0.95)
- Durable:
 - Washable, Impact-resistant
 - Scratch-resistant, Soil-resistant
- Humidity-resistant HumiGuard® Plus performance to inhibit panel sag
- ASTM E1264 Classification – Type XII, Form 2, Pattern E

Optima® Radial Overview

The following are key design factors to consider for Optima Radial ceilings. Please review these system capabilities and limitations carefully.* For additional information, consult the Optima Radial Technical Guide, CS-4161.

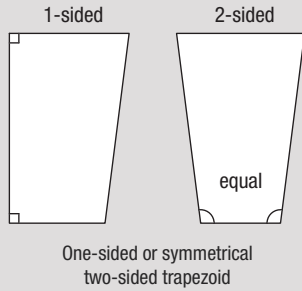

One-sided:

- A one-sided trapezoidal panel is available
- Refer to Optima Radial Technical Guide for additional capabilities

Two-sided:

- A two-sided trapezoidal panel is available
- Each tapered side **MUST** be symmetrical
- Refer to Optima Radial Technical Guide for additional capabilities

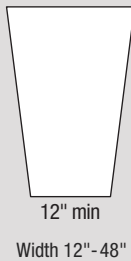

Width:

- Trapezoid panels are available in widths from 12" to 48"

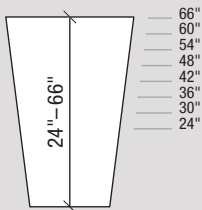

Length:

- Trapezoidal panels are available in 8 lengths from 24" to 66"
- Lengths are only available in the following 6" increments: 24," 30," 36," 42," 48," 54," 60" and 66"

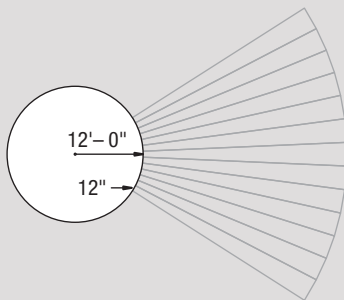

Minimum radius:

- The minimum achievable radius is 12'. This is based on a minimum panel edge of 12" with the maximum tapers noted below
- Optima Radial **CANNOT** be used inside this 12' radius – drywall may be a suitable alternative

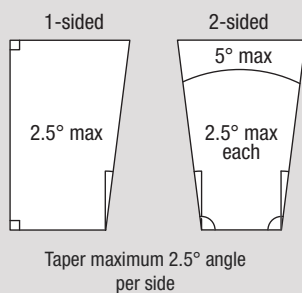

Taper:

- The maximum taper angle per side for all trapezoids is 2.5 degrees
- For two-sided trapezoids, the taper angle must be equal on both sides (i.e., symmetrical) for a maximum of 5 degrees

* Note: These do not apply to WoodWorks® or MetalWorks™ Radial ceilings. Please consult with Architectural Specialties at 1 877 ARMSTRONG and select options 1-1-4, or visit armstrongceilings.com/radial for more details.

CEILING SYSTEMS

Between us, ideas become reality™

armstrongceilings.com/radial

- Latest product and program news
- Real-time selection and specification information
- Glossary of technical terms
- Contacts – reps, where to buy, who will install
- Submittal pages
- Specification writing tool
- Product literature and samples – try Swatch It™ on the web



Online tool that allows you to visually create and download MetalWorks and WoodWorks ceiling and wall swatches – color, perforation and pattern – watch as your swatch comes to life! armstrongceilings.com/swatchit

LEED® is a registered trademark of the U.S. Green Building Council
All other trademarks used herein are the property of AWI Licensing Company and/or its affiliates
© 2010 AWI Licensing Company • Printed in the United States of America

TechLine® / 1 877 ARMSTRONG
1 877 276 7876
armstrongceilings.com/radial
CS-3648-110

 **Armstrong**®
CEILING SOLUTIONS