

# Ceiling system overview

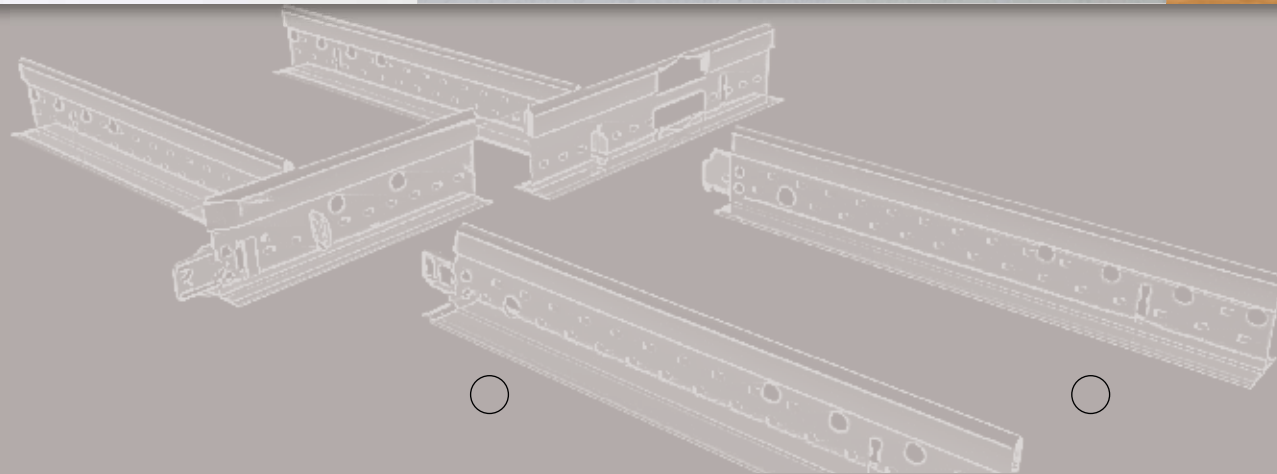

# How **to use** the brochure?

## This brochure includes Armstrong standard products:

- The **Mineral** range
- The **Metal** range
- The **Wood** range
- The **Island** range
- The **Suspension Systems** range

## The Overview brochure is organised in two different formats to help you find the most suitable solutions for your project needs.

### ■ By product performance:

This section will help you to identify the ceiling you need, according to the performance required (acoustics, fire, light reflectance, washability or hygiene).

### ■ By texture and material:

This section will help you to identify the ceiling you need, according to the visual effect expected.

		Recycled Content (%)	Light Reflectance (%)	$\alpha_w$	NRC	$D_{nfw}$	Fire Reaction	% RH	Tiles					Planks	
									T24			T15		T24	Semi-Concealed & Concealed
									Board	Tegular	Vector	MicroLook	MicroLook BE	Board	SL2
Specific Solutions	Bioguard Plain (ISO 5)	52	87	0,15(L)	0,15	37*	A2-s1, d0	95	■ ■ ■	■		■			
	Bioguard Acoustic (ISO 5)	45	85	0,60(H)	0,60	36	A2-s1, d0	95	■ ■ ■	■		■			
	Metal Bioguard (ISO 3)	30	≤ 85	≤ 0,65***	≤ 0,60***	40*	A2-s1, d0	≤ 100	■ ■ ■ ■ (1)	■ ■ ■ ■	■	■ ■ ■ ■		■ ■ ■ ■ (1) (2)	
	Clean Room FL (ISO 5)	--	78	0,15	0,10	36*	A2-s1, d0	95	■ ■ ■						
	Parafon Hygien (ISO 5)	--	82	0,95	0,95	--	A2-s1, d0	95	■ ■ ■						
	Hydroboard	--	82	0,95	0,90	22*	A1	≤ 100	■ ■ ■						
	Newtone	--	84	0,10(L)	0,10	37*	A2-s1, d0	100	■						
	Ceramaguard	38	79	0,55(MH)	0,60	39*	A1	100	■ ■ ■						
Island Ceilings	Optima Canopy**	82	90	***	***	N/A	B-s1, d0	90		Concave	Convex	Flat			
	Ultima Canopy	44	85	***	***	N/A	A2-s1, d0	70	■		■				
	Metal Canopy	30	85	***	***	N/A	B-s2, d0	90	■		■	■			
	Axiom Canopy	25	≤ 90	***	***	N/A	--	N/A				■ (3)			

■ 600 x 600 mm or equivalent. ■ 600 x 1200 mm, 300 x 1200 mm or equivalent.

\*Dncw performance. \*\*10 shapes available. \*\*\*please refer to product data page or contact us for further details.

(1) Same format for the CLIP-IN range. (2) HOOK-ON metal planks. (3) various size modules available.

		Recycled Content (%)	Light Reflectance (%)	$\alpha_w$	NRC	D <sub>nfw</sub>	Fire Reaction	% RH	Tiles					Planks	
									T24			T15		T24	Semi-Concealed & Concealed
									Board	Tegular	Vector	MicroLook	MicroLook BE	Board	SL2
Mineral	Ultima	33	87	≤ 0,75(H)	≤ 0,75(H)	≤ 40	A2-s1, d0	95	■	■	■		■		■
	Ultima OP	30	86	1,00	0,95	26	A2-s1, d0	95	■	■		■			
	Ultima dB	64	87	≤ 0,65(H)	≤ 0,70	≤ 43	A2-s1, d0	95	■	■			■		■
	Optima	82	87	≤ 1,00	≤ 1,00	--	A2-s1, d0	95	■	■	■	■		■	
	Perla	33	86	0,65(H)	0,70	35	A2-s1, d0	95	■	■			■		
	Perla OP 0,95	≤ 53	85	0,95	0,90	≤ 27	A2-s1, d0	95	■	■		■		■	■
	Perla OP 1,00	36	85	1,00	0,95	25	A2-s1, d0	95	■	■		■			
	Perla dB	65	86	≤ 0,60(H)	≤ 0,65	≤ 43	A2-s1, d0	95	■	■			■		■
	Nevada	--	82	≤ 1,00	≤ 0,95	≤ 27*	A1	95	■	■		■		■	
	Colortone Nevada	--	--	1,00	0,95	24*	A1	95	■	■					
	Sierra OP	15	83	0,90	0,85	≤ 29	A2-s1, d0	95	■	■		■		■	■
	Dune Supreme	42	84	0,55	0,50	35*	A2-s1, d0	99	■	■		■			
	Dune Supreme Unperforated	42	85	0,15(L)	0,20	35*	A2-s1, d0	99	■	■		■			
	Dune Vector	31	85	0,65	0,65	35	A2-s1, d0	99			■				
	Dune Max	45	84	0,65	0,60	35	A2-s1, d0	99	■	■		■			
	Dune dB	60	84	0,60	0,55	39	A2-s1, d0	95	■	■			■		
	Dune Planks	42	84	0,55	0,50	38	A2-s1, d0	95							■
	Colortone Dune	51	--	0,55	0,55	35*	A2-s1, d0	95	■	■		■			
	Cirrus	33	83	0,55(H)	0,50	36*	A2-s1, d0	95	■	■			■		
	Cirrus Image	33	83	0,55(H)	0,55	36*	A2-s1, d0	70				■			
Contrast	33	83	0,55	0,50	36*	A2-s1, d0	95				■				
Plain	≤ 44	87	0,15(L)	0,15	37*	A2-s1, d0	95	■	■		■				
Graphis	51	92	0,15(L)	0,15	36*	A2-s2, d0	70				■				
Visual	70	--	≤ 0,95	≤ 0,90	--	A2-s1, d0	70				■				
Fine Fissured	≤ 51	85	0,60(H)	0,60	34*	A2-s1, d0	95	■	■		■				
Fine Fissured Black	≤ 51	9	0,60(H)	0,60	36	A2-s2,d0	95	■							
Cortega	≤ 51	82	0,55(H)	0,55	34*	A2-s1, d0	70	■	■						
Tatra	≤ 51	82	0,55(H)	0,55	34*	A2-s1, d0	70	■	■						
Metal	Ultra Microperforated	30	83**	0,40(LM)	0,55	18*	A1	95	■ (1)	■ (1)	■	■ (1)		■ (1) (2)	
	Extra Microperforated	30	80**	0,70***	0,75***	31	A2-s2, d0***	95	■ (1)	■ (1)	■	■ (1)		■ (1) (2)	
	Microperforated	30	65**	1,00***	0,90***	27	A2-s2, d0***	95	■ (1)	■ (1)	■	■ (1)		■ (1) (2)	
	Standard Perforated	30	70**	0,95***	0,90***	28	A2-s2, d0***	95	■ (1)	■ (1)	■	■ (1)		■ (1) (2)	
	Plain (ISO 3)	30	85**	0,10(L)	0,10	44*	A1	95	■ (1)	■ (1)	■	■ (1)		■ (1) (2)	
Wood	Wood Veneers	--	≤ 60	≤ 0,50(L)	≤ 0,60	--	B-s2, d0	70			■	■		■	
	Wood Laminates	--	≤ 75	≤ 0,50(L)	≤ 0,60	--	B-s2, d0	70			■	■		■	

■ 600 x 600 mm or equivalent. ■ 600 x 1200 mm, 300 x 1200 mm or equivalent. ■ Planks, 300 x 1500/1800/2500 mm or equivalent.

\*Dncw performance. \*\*RAL 9010. \*\*\*Typical values for product with Premium OP 19. For other acoustic solutions, see metal brochure.

(1) Same format for the CLIP-IN range. (2) HOOK-ON metal planks.

Laminated...

ULTIMA & OPTIMA



Ultima  
Ultima OP  
Ultima dB  
Optima

PERLA & NEVADA



Perla  
Perla OP  
Perla dB  
Nevada

COLORTONE NEVADA

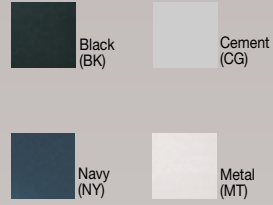

SIERRA OP



Fine...

DUNE



Dune Supreme  
Dune Max  
Dune dB

DUNE UNPERFORATED



COLORTONE DUNE



CIRRUS



Cirrus

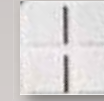

Cirrus  
Image

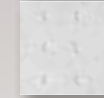

Contrast  
Square



Contrast  
Circles

Plain...

PLAIN



Plain



Graphis  
Puntos

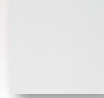

Graphis  
Linear



Graphis  
Cuadros



Graphis  
Neocubic



Graphis  
Diagonal



Graphis  
Mix A & B

Open Cell

VISUAL V49 & V64

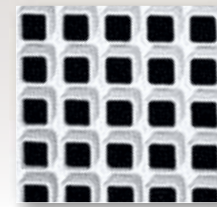

Fissured...

FINE FISSURED



Black

Fine Fissured

CORTEGA



TATRA



Patterns...

PLAIN

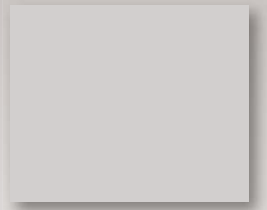

ULTRA MICROPERFORATED



EXTRA MICROPERFORATED



MICROPERFORATED



STANDARD PERFORATED

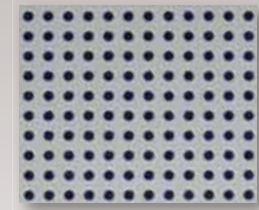

OPEN CELL / CELLIO



Systems...

CLIP-IN

Q-Clip, R-Clip, T-Clip, S-Clip



LAY-IN

Axal Vector



LAY-IN

Board



LAY-IN

Tegular 2, 8, 11F, 16



LAY-IN

MicroLook 8, 16



HOOK-ON

R-H 200, R-H 215



Wood Laminates...

CURLY MAPLE (CM)



LIME TREE (LM)



PEAR (PH)



Wood Venners...

BEECH (BH)



US CHERRY (UC)



US MAPLE (UM)



Perforations...

A1

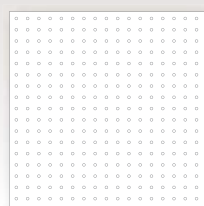

A2

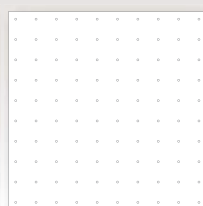

A8

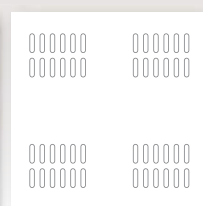

A10

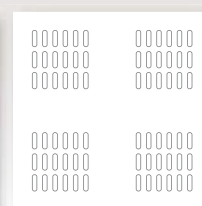

A12



Specific Solutions

ISO...

BIOGUARD



Plain

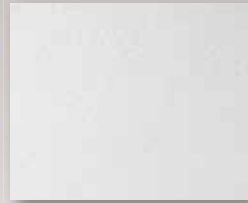

Acoustic



Metal

CLEAN ROOM FL



PARAFON HYGIEN



GRID - CLEAN ROOM

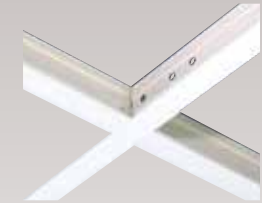

RH...

HYDROBOARD

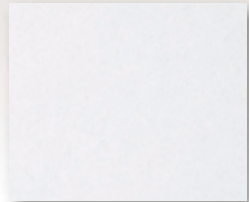

NEWTONE



CERAMAGUARD



GRID - CORROSIVE RESISTANT

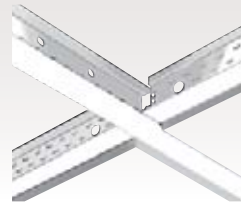

Specific Solutions

Suspension Systems

AXIOM PROFILE  
AXIOM TRANSITION



INTERLUDE 15 mm  
XL<sup>2</sup>



SILHOUETTE 15 mm  
XL<sup>2</sup>



PRELUDE 15 mm  
XL<sup>2</sup> / TL



PRELUDE 24 mm  
XL<sup>2</sup> / TLX



PRELUDE SIXTY<sup>2</sup> 24 mm  
XL<sup>2</sup> / TLX



PRELUDE 35 mm  
XL<sup>2</sup>



BANDRASTER



SYSTEM Z

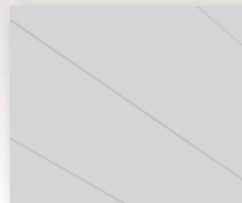

CORROSIVE RESISTANT  
24 mm



CLEAN ROOM  
24 mm



Suspension Systems



Mineral...

OPTIMA CANOPY



10 standard shapes are available

ULTIMA CANOPY



Convex

ULTIMA CANOPY



Concave

Metal...

METAL CANOPY



Concave, convex or flat

D-H 700 / D-CLIP



Axiom...

AXIOM C CANOPY



AXIOM KE CANOPY



# Recommended products...

Open space, library, lounge area  
- Concentration -

- OP range: Ultima, Perla, Sierra
- Optima, Nevada
- Ultima & Optima Canopies

Meeting room, classroom  
- Intelligibility -

- Ultima, Perla, Dune Max

Private office, consultation room  
- Confidentiality -

- dB range: Ultima, Perla, Dune Supreme
- Metal Premium B15

Corridor  
- Accessibility -

- Mineral & Metal Planks, Metal Corridor Ceilings
- Island range: Mineral, Metal & Wood

Canteen, restaurant  
- Acoustical comfort -

- OP range: Ultima, Perla, Sierra
- Optima, Nevada
- Ultima & Optima Canopies

Reception area, halls  
- Design -

- Island range: Mineral, Metal & Wood

Kitchen  
- Hygiene (ISO) -

- Bioguard range (Mineral & Metal) & Clean Room grid

Humid area  
- Humidity resistance (100% RH) -

- Ceramaguard, Newtonone, Hydroboard

## Our website...



www.armstrong.eu

Check out our new website and find solutions using the latest selection criteria: Product type shape, dimension, application, acoustic solutions and much more..

# A large choice of brochures...



Technical datasheets



Segment kits

