

How to install your 12" × 12" Ceiling Tile using the Easy Up® Installation System or Adhesive



BEFORE YOU BEGIN:

- Store and install ceilings in areas with a temperature range of 60° to 85° F and not more than 70% relative humidity.
- Remove ceiling tile from cartons 24 hours before installation and allow to adjust to normal interior conditions of the installation area.
- Do not apply loose fill or batt insulation so that it rests directly on the back of the tiles.
- Do not install ceiling tiles below embedded radiant-heat coils.
- Keep hands clean during tile installation to avoid fingerprints and smudges.
- Handle ceiling tiles carefully to protect the face and edges from damage.
- Always cut ceiling tiles face up with a sharp utility knife.
- For Adhesive Applications of mineral fiber only tiles directly to existing drywall or plaster ceilings: Ceiling tile adhesive recommended, such as Henry 237 AcoustiGum™ Acoustical Ceiling Tile Adhesive. Please follow adhesive manufacturer's instructions for application and usage. Armstrong does not guarantee the performance of this or other adhesive products, either alone or in conjunction with Armstrong® products.

SAFETY TIPS:

- Establish and maintain adequate ventilation in the work area. If high dust levels are anticipated during installation, such as with the use of power tools, take proper precautions.
- Wear long-sleeve, loose fitting clothing and gloves.
- Wear safety glasses to minimize the risk of eye injury.
- Use a sharp utility knife to ensure clean cuts. When not in use, store properly.

MAINTENANCE HINTS:

- This tile may be cleaned by lightly wiping with a soft, damp cloth, or by using a vacuum hose with a soft brush attachment.
Do not scrub, immerse, or soak tiles in water or use soap.

TOOLS NEEDED TO INSTALL YOUR CEILING

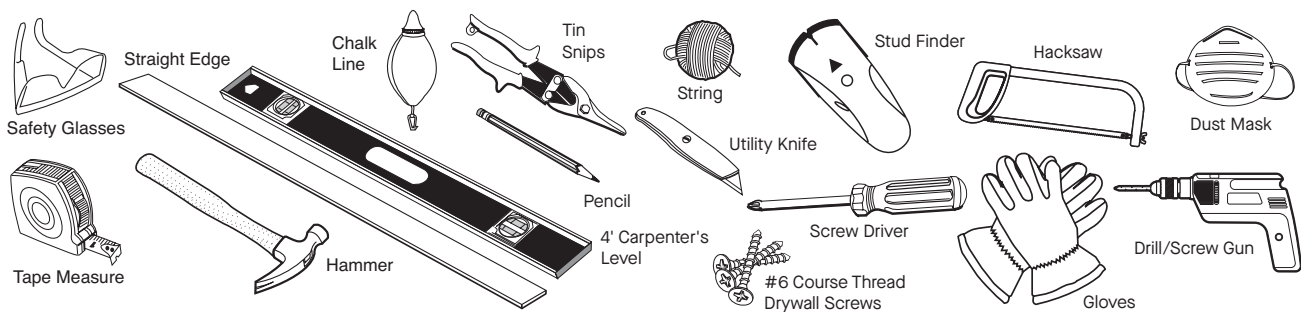

How to install your 12" × 12" Ceiling Tile using the Easy Up® Installation System or Adhesive



HELPFUL HINTS:

Keeping the tiles “square” to one another is a key part of the installation process.

- Proper installation will have all the edges of the tiles in line, with no staggering or gaps, and the entire tile edge in full contact with the neighboring tile.
- By installing the ceiling in this manner, you can ensure a visually appealing ceiling.
- When installing the string line to guide the first row of tiles, check that the string is close to square with the side wall.
- You can do this by using the **3-4-5 triangle method**.

3-4-5 Triangle Method

- Measure 3 feet from the corner in one direction and make a mark.
- Measure 4 feet from the corner in the other direction and make a mark.
- Measure the distance between your marks.
 - If the distance is 5 feet, your corner is square.
 - If the distance is less than 5 feet, your corner has a measurement of less than 90 degrees.
 - If the distance is over 5 feet, your corner has a measurement of more than 90 degrees.
- If the walls are out of square by a large margin, you may want to balance out the difference.
- It is critical to get the first row of tiles straight.
- This is accomplished by following the string line and not the wall.
- Walls can be irregular throughout a room, especially in corners.
- Trim tile to fit as you follow the string.
- Use a scrap piece of tile to “tap in” and line up the good tile.
- You can tap the scrap tile gently with a hammer to avoid damaging the tile you’re installing.

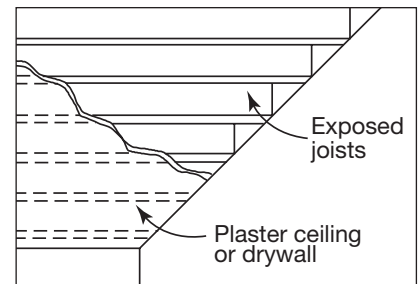

BEGIN INSTALLATION

Locate ceiling joists

To locate hidden joists, use either a stud finder or tap on the ceiling until you hear a solid thud. Mark the joist locations with chalk lines. Repeat this to locate other joists and determine their direction. Generally, joists are spaced 16" or 24" on center.

Determine border tile size for a balanced appearance

1. Measure room width in feet and inches

Example 10' 8"

2. Disregard full feet measurement

~~10~~' - 8"

3. Add 12" to the remaining inches

8" + 12" = 20"

4. Divide result by 2

20" ÷ 2" = 10"

5. Record your border tile width (side wall)

10"

6. Repeat 1-5 for opposite wall

Calculate your room (side to side)

Calculate your room (front to back)

_____	_____
_____	_____
_____	_____
_____	_____
_____	_____
_____	_____

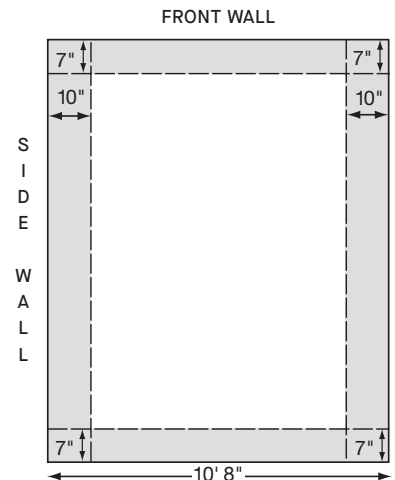

How to install your 12" × 12" Ceiling Tile using the Easy Up® Installation System or Adhesive



STEP 1: INSTALL TRACK

- Run Easy Up® track in the opposite direction of the joists. Install track with #6 coarse thread screws. Screw length may vary, depending on your existing ceiling type. Over plaster – 3" screw; over drywall – 2" screw; direct to joists – 1 5/8" screw.

NOTE: If necessary, you can shim Easy Up tracks to improve the flatness of your existing ceiling.

- Screw first row of track 2" from the side wall. Use a screw at every joist. Continue installing first row of track end-to-end or overlapped side to side (*illus. A*). Track should be installed flush to the front and back walls. To finish a row of track, cut to fit using tin snips or a hacksaw.
- From the side wall, measure border tile width minus 2". (**Border tile width was calculated on the first page.**) Install second row of track parallel to the first at that point. (*illus. B*)
- Install remaining rows 12" on center. (*illus. B*)
- Install the last track row 2" from the opposite side wall. (*illus. C*)

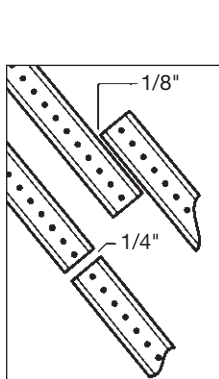

illus. A

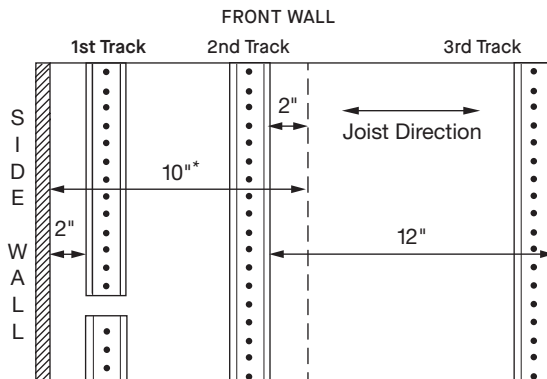

*Border tile width calculated on the first page.

illus. B

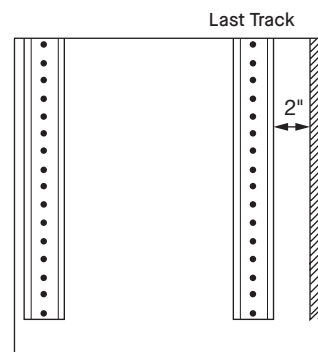

illus. C

STEP 2: INSTALL TILE

Guide String and First Border Tile Cut

- Install a guide string along the front wall. Position at the calculated border width from the front wall, about 3/4" below the tracks.
- Familiarize yourself with the flanged edges of the tile before you begin cutting your first tile. (*illus. D*)
- **Side wall:** Cut tile to the side wall border tile width, face-up with sharp utility knife. Do not cut off flange sides of tile.
- **Front wall:** Cut tile to front wall border dimension.
- The flange is not part of the border tile measurement. Measure tile face only.

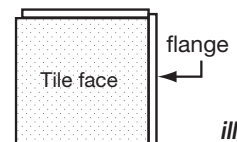

illus. D

Install First Border Tile (Tile 1 in *illus. E*)

NOTE: Refer to *Illustration E* for proper order of installing tiles.

- Snap a clip onto the first two tracks, teeth facing out.
- Push clips flush against wall.
- Push first tile firmly into corner (*illus. F*) by embedding clips into cut edge.

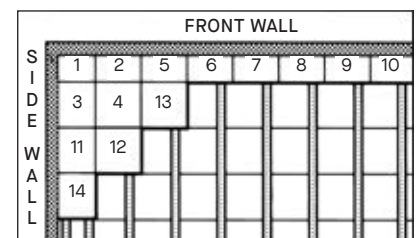

illus. E

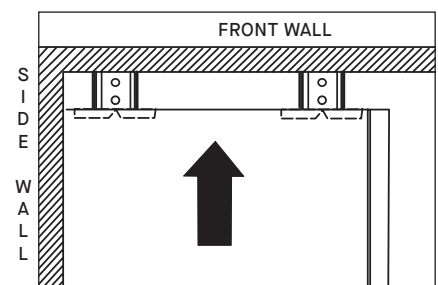

illus. F

How to install your 12" × 12" Ceiling Tile using the Easy Up® Installation System or Adhesive



- Snap 2 new clips onto tracks and slide teeth over flange to secure flange side of tile. (*illus. G*)
- Lightly tap clips with hammer to seat tile tightly to front wall. Make sure the tile face edge is aligned with guide string. (*illus. H*)

Install Second Border Tile (Tile 2 in *illus. E*)

- Follow the same procedure as first border tile, measuring and trimming along front edge only (not flange edge). Push flange edge firmly into first border tile.

Begin Installing Row Two (Tile 3 in *illus. E*)

- Trim tile to the side wall border tile width.
- Install with clips.
- Slide into place making sure the face edge is aligned with tile 1.

Install First Full Tile (Tile 4 in *illus. E*)

- Align tile squarely with the adjacent 3 tiles. Make sure all face edges are aligned.

Install Remaining Tiles

Complete first row (border) keeping tile face edge, not flange edge, flush with guide string. (*illus. E and illus. H on page 2*)

- Continue installing tile using diagonal sequence shown. (*illus. E*)
- Snap a clip onto the track before inserting the last row of tile, and push flush with end wall.
- Cut the border tiles against the end wall 1/2" short to allow for expansion as room conditions change.
- Install end wall border tiles and use a screwdriver next to the wall to embed the clip into the cut edge of the tile. (*illus. I*)

STEP 3: INSTALL WALL MOLDING

- Paint or stain decorative molding before installing.
- Install molding at the joint between the ceiling and walls.
- Nail molding into the wall studs at least every 24". (*illus. J*)

NOTE: All Armstrong® 12" × 12" ceiling tiles can be painted with latex paint. The front and back of the tile should be painted. Armstrong cannot guarantee that the published surface-burning characteristics, fire-resistance ratings, acoustical performance, dimensional stability/sag, or light reflectance will remain the same after repainting. Field painting will void the warranty.

For additional information and videos about installing ceilings, including special installation tips and warranty, please visit our website at ceilings.com/installation or call Techline at 1-877-ARMSTRONG (276-7876).

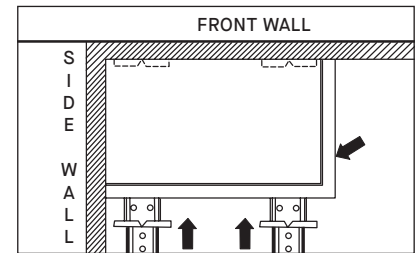

illus. G

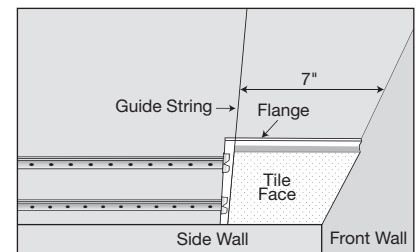

illus. H

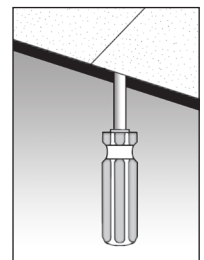

illus. I

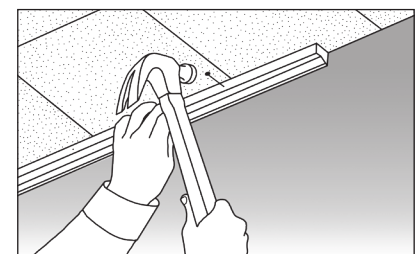

illus. J