

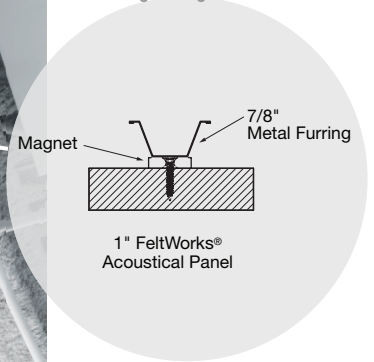

FeltWorks® Acoustical Ceiling Panels in White

CAD/Revit® drawings at:
armstrongceilings.com/cadrevit



plus capabilities
to do more



armstrongceilings.com/capabilities
See more photos at:
armstrongceilings.com/photogallery

Soft visual and excellent noise control with versatile installation options for design flexibility.

KEY SELECTION ATTRIBUTES

- new** Available in three standard, nominal sizes: 24" x 48", 48" x 48" and 48" x 96"
- Quick and easy retrofit acoustical solution
- Excellent sound absorption – NRC up to 0.90
- new** Sustainable Beyond Standard: Custom sizes and all standard panels are part of the Sustain® portfolio and meet the most stringent industry sustainability compliance standards today
- CleanAssure™ family of products – includes disinfectable panels, suspension systems, and trim
- Select products included in the FAST134 program – ready to ship in 4 weeks or less
- Mold- and mildew-resistant surface
- No need to field-finish cut edges with color throughout panels
- Custom sizes available from 18" x 18" up to 54" x 120"
- No visible fasteners with adhesive or magnet installation options
- FeltWorks acoustical panels are lightweight and easy to install in any ceiling application. Many install options:
 - Attachment with adhesive to drywall or cement
 - Attachment with magnets to metal furring or drywall grid
 - Visible attachment with screw and washer to metal furring or drywall grid

TYPICAL APPLICATIONS

- Exposed structure
- Open plenum offices
- Drywall spaces requiring acoustical correction
- Retail
- Hospitality

COLORS Due to printing limitations, shade may vary from actual product.





DETAILS













1. Square Panel Edges (48 x 96 x 1" ONLY)
2. Beveled Panel Edges (24 x 48 x 1" and 48 x 48 x 1" ONLY)
3. 1" diameter magnet (back of panel and no visible fasteners)
4. Magnetic attachment to metal furring
5. 1" washer and screw (front of panel)

VISUAL SELECTION

	Item No. ♦	Dimensions Nominal W x L x H (Inches)	Pcs/Pallet
1" Square (all sides) 	8246FWH	48 x 96 x 1"	36
	8246FBG	48 x 96 x 1"	35
	8246FLG	48 x 96 x 1"	36
	8246FDG	48 x 96 x 1"	35
	8246FBL	48 x 96 x 1"	35
Long Edges Beveled/Short Edges Beveled* 	6322W24L048B4 _ _ _	24 x 48 x 1"	6 pcs/ctn
	6322W48L048B4 _ _ _	48 x 48 x 1"	6 pcs/ctn
Custom Panel Options		W: 18" - 54" L: 18" - 120"	

PERFORMANCE
Dots represent high level of performance.

	Fire Rating	Light Reflect (White only)	Anti-Mold/Mildew	Humi-Block	Humi-Guard+	Certified Low VOC Emissions	CleanAssure™ Disinfectable Panels	DURABILITY
								
Class A	0.78	*	*	*	*	*		 
Class A	0.78	*	*	*	*	*	*	*
Class A	0.78	*	*	*	*	*	*	*

ACOUSTICAL INFORMATION

Performance determined by perforation size

Panel Thickness	NRC	Mounting Methods
1"	0.75	Adhesive
	0.80	Screw to 7/8" metal furring
	0.85	Magnet to 7/8" metal furring
	0.90	Screw or magnet to drywall grid or 1-1/2" metal furring



FAST134 program items ready to ship from manufacturer in 4 weeks or less.
Up-to-date lead times and product options (sizes and colors) at armstrongceilings.com/fast134

♦ When specifying or ordering, include the appropriate 3-digit color suffix (e.g. 8246 E W H)
NOTE: Custom panels are available by contacting ASQuote@armstrongceilings.com
* Four-sided beveled edge panels are recommended in adjoining panel installations.

ACCESSORIES

	Item No. ♦	Description	Color	Qty
Screw and Washer Installation	6488 _ _	Washers	Mill Finish (paintable), Black	1000
	6489 _ _	#8 x 1-7/8" Screws for washer installation	Mill Finish (paintable), Black	1000
Magnet Installation	6526	Magnets	N/A	120
	6527	#8 x 1" Screws for magnet installation	N/A	1000

♦ When specifying or ordering, include the appropriate 2-digit color suffix MF = Mill Finish, BL = Black

ADHESIVE (BY OTHERS)

For Adhesive Installation to Painted Drywall Ceilings

Henry® 237 AcoustiGum™ or Titebond® GREENchoice™ Acoustical Ceiling Tile Adhesive

For Magnet Installation

Original Gorilla Glue®, following manufacturer's instructions

NOTE: Armstrong Ceilings does not guarantee the performance of these or other adhesive products, either alone or in conjunction with Armstrong products.

PHYSICAL DATA

Material

Non-woven layered and formed polyester felt (PET) fiber panels with color throughout.

Fire Performance

Each color has its own test report per ASTM E84. Flame Spread Index 25 or less. Smoke Developed Index 450 or less. Class A.

1" FeltWorks® panel tested according to CAN/ULC S102.2-10. Flame Spread value 50. Smoke Developed Classification I/c p 140.

When installing FeltWorks® panels on suspended drywall grid, contact local code official for plenum code considerations related to sprinkler placement.

Acoustical Performance

FeltWorks 1" acoustical panels provide a wide range of sound absorption, from NRC 0.75 to 0.90, based on installation method used, tested per ASTM C423 and mounted in accordance with ASTM E795.

Safety Considerations

Installers and specifiers have the choice to install FeltWorks acoustical panels with magnets in projects where fasteners should not be visible. While rare earth neodymium magnets are commonly used in commercial applications, individuals with pacemakers, ICDs, or other implanted medical devices must use caution as magnets can impact performance of these devices. Consult physician for specific details.

TechLine 877 276-7876
armstrongceilings.com/feltworks

VOC Emissions

GREENGUARD Gold Certified
Third-party certified
Compliant with California Department of Public Health CDPH/EHLB/Standard Method Version 1.2, 2017.
This standard is the guideline for low emissions in LEED®, WELL Building Standard®, Living Building Challenge® (LBC), CalGreen Title 24, ANSI/ASHRAE/USGBC/IES Standard 189; ANSI/GBI Green Building Assessment Protocol.

Application Considerations

Color and texture may vary from panel to panel and from order to order. Adequate attic stock should be ordered. FeltWorks panels are not approved for exterior application. FeltWorks panels should not be installed near sources of heat greater than 158 degrees F. Adjoining panel installations are not warranted. 2" spacing between panels is required on 48" x 96" panels only. 24" x 48" and 48" x 48" beveled edge panels may be installed side-by-side with no spacing.

FAST134 Program Considerations

Size of Job Matters: Big jobs, over 2500 SF or 50 pieces for shapes/vertical elements will have longer lead times.

Location Matters: Transit time not included. We are ready to ship in 1 week on FAST1 items. However, transit to the states west of Wyoming may add time.

Distributor Truck Schedule Matters: We rely on distribution to help move products around the country. When speed matters, work with your local distributor to ensure FAST134 service.

Stock vs Made-to-order Matters: FAST3 & FAST4 items are made-to-order and will ship direct to distributor. FAST1 (stocked items) will go through distribution and depend on distributor truck schedules.

PRODUCT CERTIFIED FOR LOW CHEMICAL EMISSIONS
UL.COM/GG
UL 2818



Seismic Restraint

All FeltWorks panel installation options have been engineered, tested, and approved for use in all seismic areas. See installation instructions for details.

Cleaning and Disinfecting

Cleaning and CDC approved disinfecting options available on armstrongceilings.com/cleaning

Design Support

For custom design assistance contact ProjectWorks® Design Services or visit armstrongceilings.com/projectworks

Weight, Pieces, and SF/Pallet

8246 is shipped in pallet quantities. 6322W24L048B4 and 6322W48L048B4 panels are shipped in carton quantities.

8246 pieces per pallet will vary between 35 and 36 pieces based on color.

8246FWH: 36 pieces/pallet - 1,152 SF/pallet
8246FBG: 35 pieces/pallet - 1,120 SF/pallet
8246FLG: 36 pieces/pallet - 1,152 SF/pallet
8246FDG: 35 pieces/pallet - 1,120 SF/pallet
8246FBL: 35 pieces/pallet - 1,120 SF/pallet

6322W24L048B4: 6 pcs/carton - 48 SF/carton
6322W48L048B4: 6 pcs/carton - 96 SF/carton

Weight: 0.50 lbs/SF



INSTALLATION DETAILS



SCREW AND WASHER ATTACHMENT TO METAL FURRING

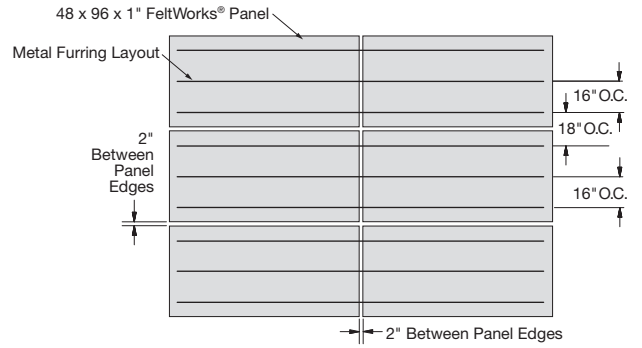
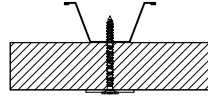

Metal furring layout (3 rows per panel) with recommended 2" gap between panels for magnet or screw & washer installation



MAGNET ATTACHMENT TO DRYWALL GRID

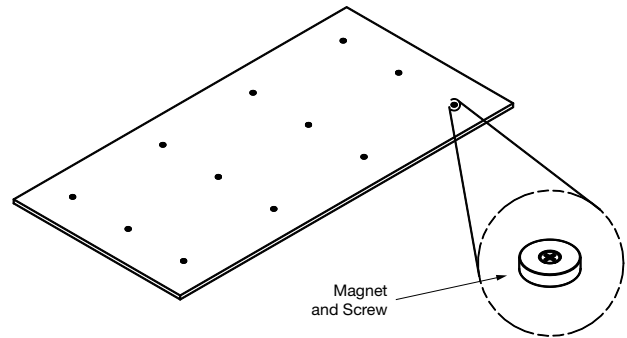
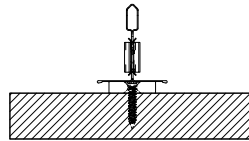

Magnet attachment to back of FeltWorks panel



INSTALLATION DETAILS



MAGNET ATTACHMENT TO METAL FURRING

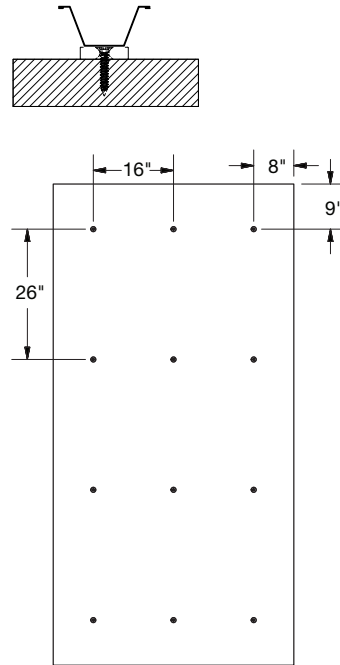

ADHESIVE ATTACHMENT

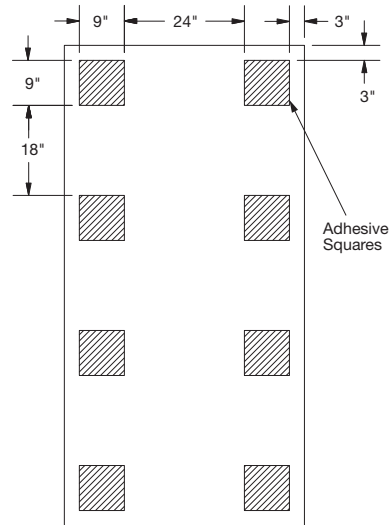
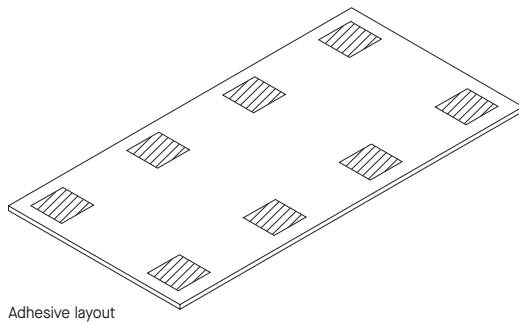

DIRECT-TO-STRUCTURE – Standard