

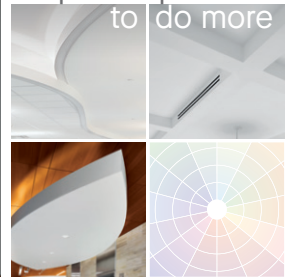

CAD/Revit® drawings at:
armstrongceilings.com/cadrevit

plus capabilities
to do more



FeltWorks® Open Cell Peaks & Valleys panels in Cotton

armstrongceilings.com/capabilities
See more photos at:
armstrongceilings.com/photogallery

FeltWorks® Open Cell panel kits add acoustics and custom looks to any interior space using Bottom, Mid, and Top 1/4" thick panels that fit together.

KEY SELECTION ATTRIBUTES

- Kits available in 3 designs: Ebbs & Flows, Peaks & Valleys, and Rectangular panels (6" or 12" depths)
- Kits can be interlinked to create a wall-to-wall installation
- FeltWorks® Open Cell panels are part of the Sustain® portfolio and meet the most stringent industry sustainability standards today
- Made from up to 60% post-consumer recycled PET fibers
- CleanAssure™ family of products – includes disinfectable panels, suspension systems, and trim
- No need to field-finish cut edges with color throughout panels
- Installation on the Hanging Kit (Item 6655) allows for panel removal for access to plenum
- Sound absorption – 0.52 Sabins/SF

COLORS Due to printing limitations, shade may vary from actual product.

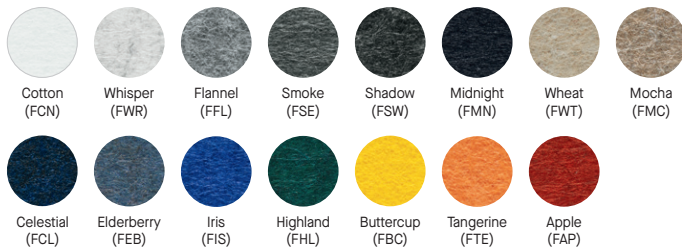

COLORS Due to printing limitations, shade may vary from actual product.



Hanging Kit (Item 6655) assembly detail

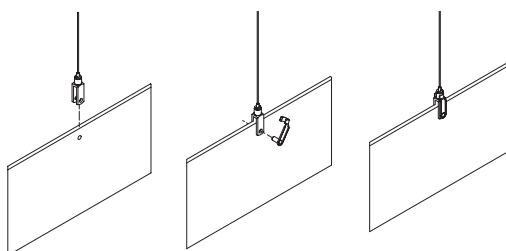

*Explore the
FeltWorks® Open Cell
Design Guide*

new FELTWORKS® Open Cell
Wall-to-Wall Ceiling Application –
Ebbs & Flows Panel Kits

SUSTAIN*
High Performance
Sustainable Ceiling Systems

Declare.

GREENGUARD
Gold Certified

LEED® WELL™ LBC

UP TO **60%** RECYCLED CONTENT

- energy management
- construction waste mgmt
- regional materials
- design for flexibility

For LEED contribution contact TechLine

LOCATION DEPENDENT

COTTON ONLY

ACOUSTICAL INFORMATION

Panel Thickness	1/4"	Sound Absorption (Sabins/SF)	Up to 0.52
-----------------	------	------------------------------	------------

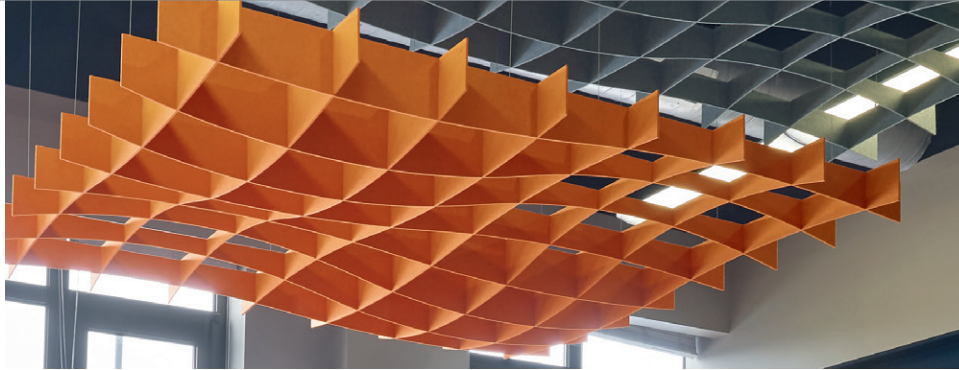

FeltWorks® Open Cell Ebbs & Flows panels in Tangerine

STANDARD KITTED MODULE OPTIONS

S8 Ebbs & Flows Open Cell Kit

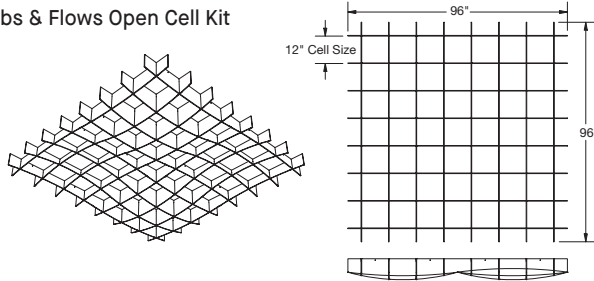

R4 or R8 Ebbs & Flows Open Cell Kit

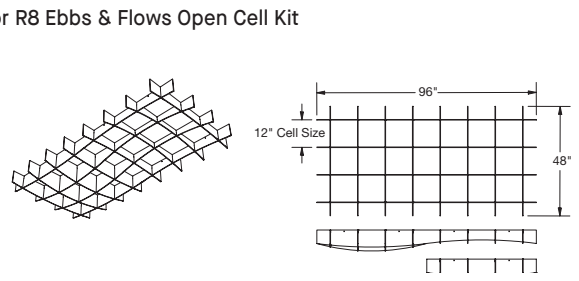

VISUAL SELECTION

	Item No. ♦	Description	Kit Nominal Dimensions (W x L x D)	Top Panel Length	Bottom Panel Length	Mid Panel Length	SF of Panels Installed	SF of Kit Space
	6532KOE09S4	S4 Ebbs & Flows Open Cell Kit (Kit includes two 48" x 48" assemblies)	48 x 48 x 9"	48"	48"	8	16	
	6532KOE09R4	R4 Ebbs & Flows Open Cell Kit	48 x 96 x 9"	48"	96"	12	32	
	6532KOE09R8	R8 Ebbs & Flows Open Cell Kit	96 x 48 x 9"	96"	48"	12	32	
	6532KOE09S8	S8 Ebbs & Flows Open Cell Kit	96 x 96 x 9"	96"	96"	16	64	

♦ When specifying or ordering, add 3-letter color suffix to item number.
NOTE: All panels in a kitted module must be the same color. A 1/4" gap exists between the ends of panels for best visual. For custom shapes, sizes, and layouts, contact ASQuote@armstrongceilings.com. See the FeltWorks® Open Cell Design Guide for easy ways to create custom looks using standard products.

PERFORMANCE

Fire Rating	Light Reflect	Certified Low VOC Emissions	CleanAssure™ Disinfectable Panels	DURABILITY			
Class 0.80 A	*	*	Spray	Water Repel	Impact	Scratch	*

Dots represent high level of performance.



new FELTWORKS® Open Cell
Wall-to-Wall Ceiling Application –
Peaks & Valleys Panel Kits

SUSTAIN
High Performance
Sustainable Ceiling Systems

Declare. GREENGUARD
Gold Certified

LEED WELL | LBC
UP TO **60%** RECYCLED CONTENT

energy management
construction waste mgmt
regional materials
design for flexibility

EPD
recyclable/extended producer resp.
biobased materials
recycled content
sourcing of raw materials
material ingredient reporting
low emitting materials
lighting quality
acoustics

LOCATION DEPENDENT

For LEED contribution contact TechLine

ACOUSTICAL INFORMATION

Panel Thickness	1/4"	Sound Absorption (Sabins/SF)	Up to 0.52
-----------------	------	------------------------------	------------



FeltWorks® Open Cell Peaks & Valleys panels in Cotton

STANDARD KITTED MODULE OPTIONS

S8 Peaks & Valleys Open Cell Kit

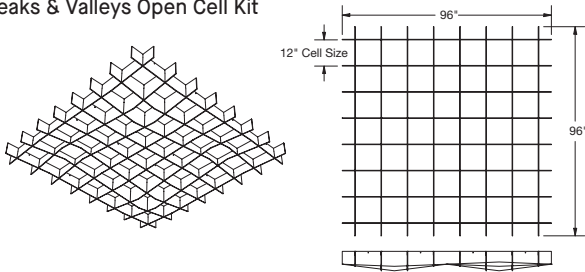

R4 or R8 Peaks & Valleys Open Cell Kit

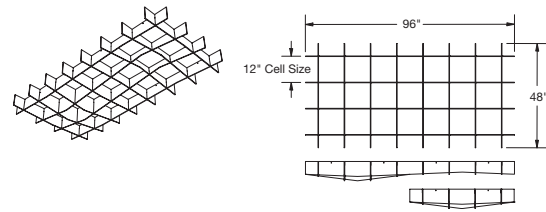

VISUAL SELECTION

Peaks & Valleys Open Cell Kits	Item No. ♦	Description	Top & Bottom Mid			SF of Panels Installed	
			Kit Nominal (W x L x D)	Panel Length	Panel Length per Kit		
	6532KOP09S4_	S4 Peaks & Valleys Open Cell Kit (Kit includes two 48" x 48" assemblies)	48 x 48 x 9"	48"	48"	8	16
	6532KOP09R4_	R4 Peaks & Valleys Open Cell Kit	48 x 96 x 9"	48"	96"	12	32
	6532KOP09R8_	R8 Peaks & Valleys Open Cell Kit	96 x 48 x 9"	96"	48"	12	32
	6532KOP09S8_	S8 Peaks & Valleys Open Cell Kit	96 x 96 x 9"	96"	96"	16	64

PERFORMANCE

Fire Rating	Light Reflect	Certified Low VOC Emissions	CleanAssure™ Disinfectable Panels		DURABILITY			
			Spray	Water Repel	Impact	Scratch		
Class A	0.80	*	*	*	*	*	*	*

(Cotton only)

♦ When specifying or ordering, add 3-letter color suffix to item number.
NOTE: All panels in a kitted module must be the same color. A 1/4" gap exists between the ends of panels for best visual.
For custom shapes, sizes, and layouts, contact ASQuote@armstrongceilings.com
See the FeltWorks® Open Cell Design Guide for easy ways to create custom looks using standard products.

Dots represent high level of performance.



new FELTWORKS® Open Cell
Wall-to-Wall Ceiling Application –
Rectangular Panel Kits

SUSTAIN*
High Performance
Sustainable Ceiling Systems

Declare.

GREENGUARD
Gold Certified

LEED® WELL | LBC

UP TO **60%** RECYCLED CONTENT

energy management
construction waste mgmt
regional materials
design for flexibility

EPD
recyclable/producer resp.
biobased materials
recycled content
sourcing of raw materials
material ingredient reporting
low emitting materials
lighting quality
acoustics

LOCATION DEPENDENT

COTTON ONLY

For LEED contribution contact TechLine



FeltWorks® Open Cell Rectangles panels in Smoke

ACOUSTICAL INFORMATION

Panel Thickness	1/4"	Sound Absorption (Sabins/SF)	Up to 0.52
-----------------	------	------------------------------	------------

STANDARD KITTED MODULE OPTIONS

S8 Rectangles 6" Depth Open Cell Kit

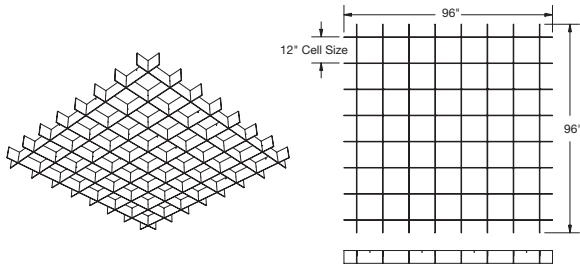

S8 Rectangles 12" Depth Open Cell Kit

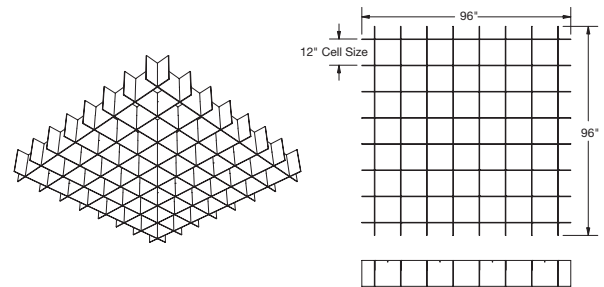

VISUAL SELECTION

	Item No. ♦	Description	Kit Nominal Dimensions (W x L x D)	Top Panel Length	Bottom Panel Length	Mid Panel Length	SF of Panels Installed per Kit Space
	6532KOR06R8 _ _ _	R8 Rectangles 6" Depth Open Cell Kit	96 × 48 × 6"	96"	48"	12	32
	6532KOR06S8 _ _ _	S8 Rectangles 6" Depth Open Cell Kit	96 × 96 × 6"	96"	96"	16	64
	6532KOR12R8 _ _ _	R8 Rectangles 12" Depth Open Cell Kit	96 × 48 × 12"	96"	48"	12	32
	6532KOR12S8 _ _ _	S8 Rectangles 12" Depth Open Cell Kit	96 × 96 × 12"	96"	96"	16	64

♦ When specifying or ordering, add 3-letter color suffix to item number.
NOTE: All panels in a kitted module must be the same color. A 1/4" gap exists between the ends of panels for best visual. For custom shapes, sizes, and layouts, contact ASQuote@armstrongceilings.com
See the FeltWorks® Open Cell Design Guide for easy ways to create custom looks using standard products.

PERFORMANCE

Fire Rating	Light Reflect	Certified Low VOC Emissions	CleanAssure™ Disinfectable Panels		DURABILITY	
			Spray	Impact	Scratch	
Class A	0.80	*	*	*	*	*
Class A	0.80	*	*	*	*	*
Class A	0.80	*	*	*	*	*
Class A	0.80	*	*	*	*	*

Dots represent high level of performance.



new FELTWORKS® Open Cell
Wall-to-Wall Ceiling Application



Declare.

GREENGUARD Gold Certified

LEED WELL | LBC
UP TO 60% RECYCLED CONTENT

- energy management
- recyclable/extended producer resp.
- construction waste mgmt
- regional materials
- design for flexibility
- EPD

For LEED contribution contact TechLine

- biobased materials
- recycled content
- sourcing of raw materials
- material ingredient reporting
- low emitting materials
- lighting quality
- acoustics

LOCATION DEPENDENT

COTTON ONLY

STANDARD KITTED MODULE OPTIONS

R4 or R8 Rectangles 6" Depth Open Cell Kit

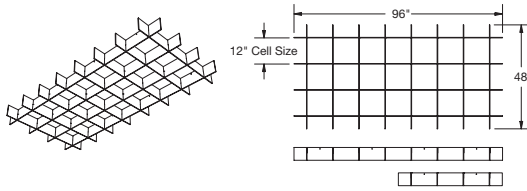

R4 or R8 Rectangles 12" Depth Open Cell Kit

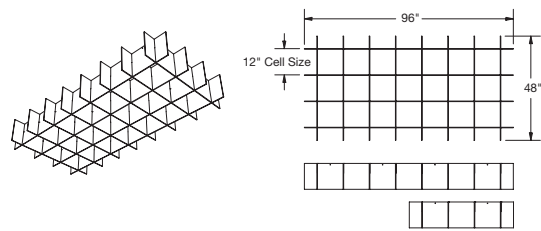

VISUAL SELECTION

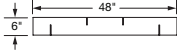
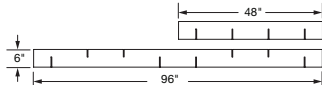
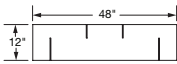
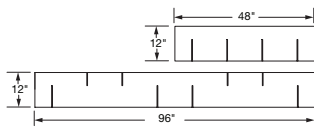
	Item No. ◆	Description	Kit Nominal Dimensions (W x L x D)	Top & Bottom Panel Length	Mid Panel Length per Kit	Panels Installed	SF of Installed Space
	6532KOR06S4	S4 Rectangles 6" Depth Open Cell Kit (Kit includes two 48" x 48" assemblies)	48 x 48 x 6"	48"	48"	8	16
	6532KOR06R4	R4 Rectangles 6" Depth Open Cell Kit	48 x 96 x 6"	48"	96"	12	32
	6532KOR12S4	S4 Rectangles 12" Depth Open Cell Kit (Kit includes two 48" x 48" assemblies)	48 x 48 x 12"	48"	48"	8	16
	6532KOR12R4	R4 Rectangles 12" Depth Open Cell Kit	48 x 96 x 12"	48"	96"	12	32

PERFORMANCE

Fire Rating	Light Reflect	Certified Low VOC Emissions	CleanAssure™ Disinfectable Panels		DURABILITY		
			Spray	Water Repel	Impact	Scratch	
Class A	0.80	*	*	*	*	*	*
Class A	0.80	*	*	*	*	*	*
Class A	0.80	*	*	*	*	*	*
Class A	0.80	*	*	*	*	*	*

Dots represent high level of performance.

◆ When specifying or ordering, add 3-letter color suffix to item number.
NOTE: All panels in a kitted module must be the same color. A 1/4" gap exists between the ends of panels for best visual.
For custom shapes, sizes, and layouts, contact ASQuote@armstrongceilings.com
See the FeltWorks® Open Cell Design Guide for easy ways to create custom looks using standard products.



new FELTWORKS® Open Cell
Wall-to-Wall Ceiling Application



Declare.

GREENGUARD
Gold Certified

LEED® WELL™ LBC

UP TO 60% RECYCLED CONTENT

For LEED contribution contact TechLine

energy management	construction waste mgmt	regional materials	design for flexibility	EPD	recyclable/repurposed producer resp.	biobased materials	recycled content	sourcing of raw materials	material ingredient reporting	low emitting materials	lighting quality	acoustics

LOCATION DEPENDENT

COTTON ONLY

LAYOUT DETAILS/INSTALLATION DETAILS

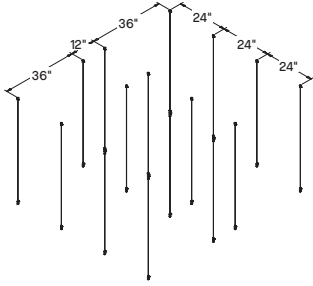

Step 1: Attach Hanging Kits to Deck

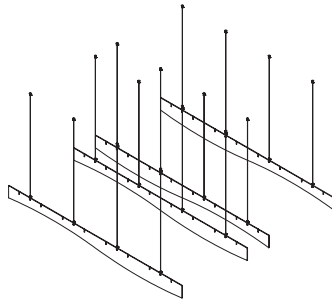

Step 2: Attach Bottom Panels to Hanging Kits

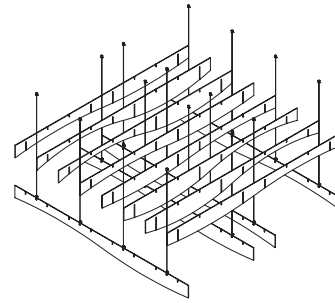

Step 3: Insert Mids Perpendicular to Bottom Panels

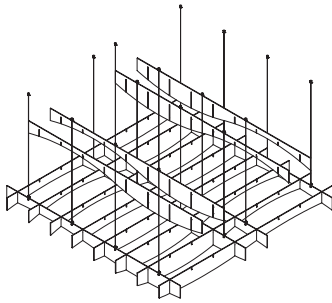

Step 4: Insert Top Panels Parallel to Bottoms

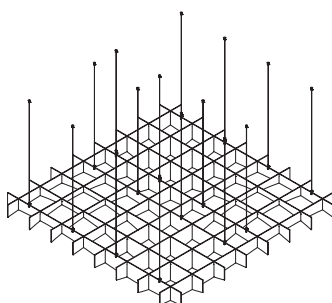

Complete Installation

SUSPENSION SYSTEMS

	Item No. ♦	Description	Color	Pcs./Ctn
Aluminum Suspension System	6655	Hanging Kit	N/A	1 kit/4 hanging assemblies

Each Blades Hanging Kit includes 4 hanging assemblies. Use one kit for each Suspension Bar.

PHYSICAL DATA

Material
1/4" thick non-woven layered and formed polyester felt (PET) fiber panels with color throughout.

Fire Performance
Flame Spread Index 25 or less. Smoke Developed Index 450 or less. Class A per ASTM E84.
CAN/ULC S102 surface burning characteristics. Flame Spread Rating of 75 or less. Smoke Developed Classification of 105.

FeltWorks® Open Cell panels, as with other architectural features located in the ceiling plane, may obstruct or skew the existing or planned fire sprinkler water distribution pattern, or possibly delay the activation of the fire sprinkler or fire detection system. Consult a fire protection engineer, NFPA 13, and local codes for guidance on the proper installation techniques where fire detection or suppression systems are present.

Application Considerations
Color and texture may vary from panel to panel and from order to order. Adequate attic stock should be ordered. Due to the nature of recycled materials, small dark fibers may be visible on light panels.

FeltWorks Open Cell panels are not approved for exterior application.
FeltWorks Open Cell panels should not be installed near sources of heat greater than 158 degrees F.

Design Support
For custom design assistance contact ProjectWorks® Design Services or visit armstrongceilings.com/projectworks

Acoustical Performance
Tested per ASTM C423 and mounted in accordance with ASTM E795. Sound absorption of 0.52 Sabins/SF. Contact TechLine for details at techline@armstrongceilings.com

VOC Emissions
GREENGUARD Gold Certified
Third-party certified compliant with California Department of Public Health CDPH/EHLB/Standard Method Version 1.2, 2017. This standard is the guideline for low emissions in LEED®, WELL Building Standard®, Living Building Challenge® (LBC), CalGreen Title 24, ANSI/ASHRAE/USGBC/IES Standard 189; ANSI/GBI Green Building Assessment Protocol.



Installation Considerations
Any fixtures adjacent to FeltWorks Open Cell panels must be independently supported.

Seismic Restraint
FeltWorks Open Cell panels have been engineered, tested, and approved for use in all seismic areas. See installation instructions for details.

Cleaning and Disinfecting
Cleaning and CDC approved disinfecting options available on armstrongceilings.com/cleaning

Warranty
Details at armstrongceilings.com/warranty

Weight; Pieces/Carton
0.33 lbs/SF
Custom quantities available, contact ASQuote@armstrongceilings.com

